

SK9822



5.4x5.0x1.6mm Top SMD Type 0.3Watt Power Double line transmission tegrated light source Intelligent control LED (MSL:5a)



Change History

Date	Rev. No.	Changes/Reason of changes	Signature
2015-05-08	01	Initial Document	KEVIN ZHU
2015-07-09	02	Revision of Specification Format	KEVIN ZHU
2016-04-25	03	Upgrade parameters	KEVIN ZHU
2017-08-16	04	Luminous Intensity	KEVIN ZHU
2018-06-15	05	Correct specifications	KEVIN ZHU
2018-12-15	06	Revision of Specification Format	KEVIN ZHU
2019-01-16	07	Revision of Specification Format	KEVIN ZHU

Voron

CONTENTS

1、Product overview.....	3
2、Main Application Field.....	3
3、Description.....	3
4、Mechanical Dimensions.....	3
5、PIN configuration.....	4
6、Recommended dimensions for PCB products.....	4
7、General description of product naming.....	4
8、Electrical parameters.....	5
9、Electrical/Optical Characteristics.....	5
10、The IC electrical parameters.....	5
11、Feature Descriptions.....	6~7
12、The typical application circuit.....	8
13、Standard LED Performance Graph.....	9
14、Packaging Standard.....	10
15、Reliability Test.....	11
Appendix 1、TOP SMD LED Application Notes.....	12~17

Voron

5. PIN configuration

Item	Symbol	Pin Name	Function description
1	SDI	Data Input	control signal Input data
2	CKI	CLK Input	control signal Input Clock data
3	GND	Ground	The signal and power supply and grounding
4	VCC	Power	power supply pin
5	CKO	CLK Output	control signal output Clock data
6	SDO	Data Input	control signal output data

6. Recommended dimensions for PCB products

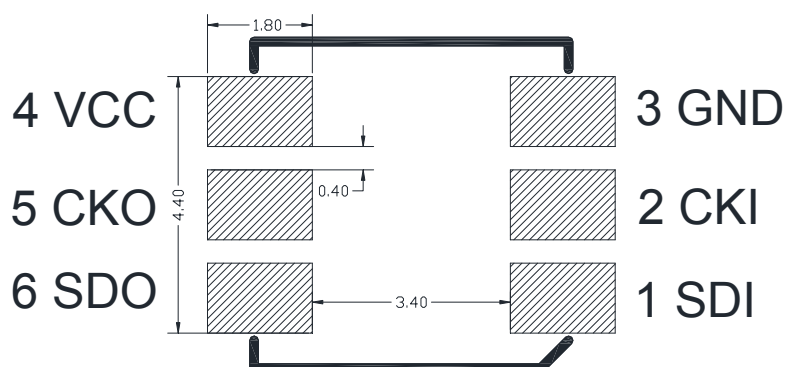

7. General description of product naming

SK 9822

①

②

①	②
series	IC series and current code
The default is to integrate the RGB chip with the IC package in 5.4x5.0*1.6mm outline	Refers to the 9822 series IC 18MA current version Double line transmission

Voron

8. Electrical Parameters (Ta=25°C, VSS=0V) :

Parameter	Symbol	Range	Unit
Power supply voltage	VDD	+3.7~+5.5	V
Logic input voltage	V _{IN}	-0.3~VDD+0.3	V
Working temperature	T _{opt}	-40~+85	°C
Storage temperature	T _{stg}	-50~+150	°C
ESD pressure(HBM)	V _{ESD}	4K	V
ESD pressure(DM)	V _{ESD}	200	V

9. Electrical/Optical Characteristics:

Color	SK9822 18MA		
	Dominant wavelength(nm)	Luminance(mcd)	luminous flux(lm)
Red	620-630	400-700	1.0-2.0
Green	515-530	1000-1500	4.0-5.0
Blue	460-475	300-500	1.0-1.5

10. The IC electrical parameters (unless otherwise specified, TA=-20 ~ +70 °C, VDD=4.5 ~ 5.5V, VSS=0V):

Parameter	Symbol	Min	Typical	Max	Unit	Test conditions
The chip supply voltage	VDD	---	5.0	5.3	V	---
The biggest LED output current	I _{max}	---	---	20	mA	---
The clock high level width	TCLKH	---	17	---	ns	---
The clock low level width	TCLKL	---	17	---	ns	---
Data set up time	TSETUP	---	---	10	ns	---
The frequency of PWM	FPWM	---	4.6	---	KHZ	---
Static power consumption	IDD	---	1	---	mA	---

Voron

11. Feature Descriptions:

(1) Series data structure

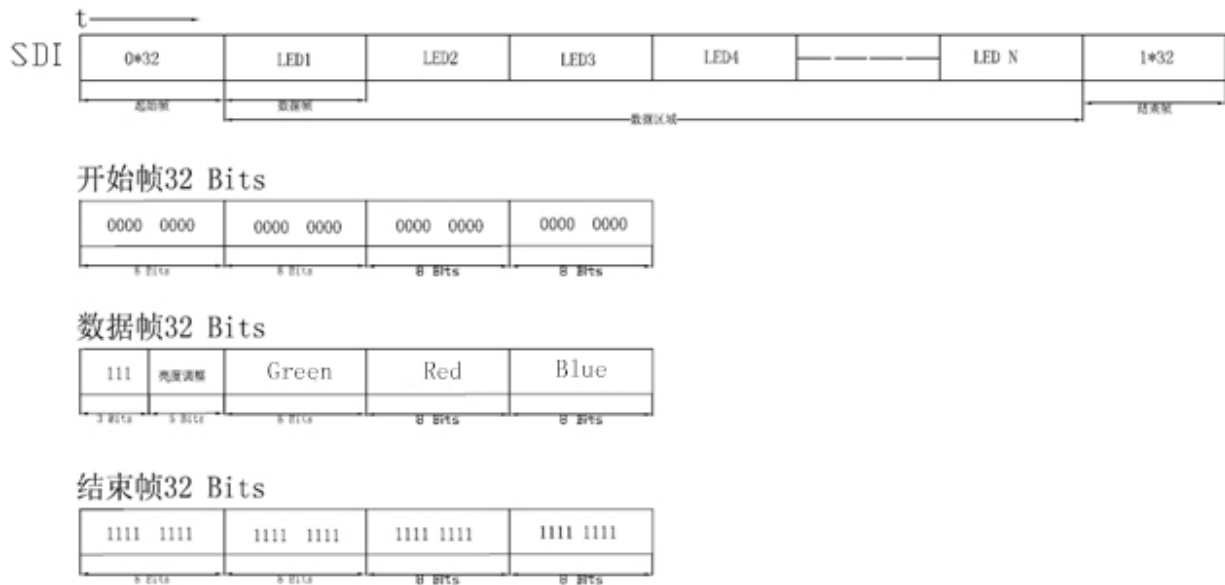

Product structure: GRB order output light, optimize the product blending effect (adjusted IC default RGB order wafer position)

Voron

(2) 256 level gray level:

Data	Duty Cycle
MSB.....LSB	
0000 0000	0/256
0000 0001	1/256
0000 0010	2/256
-	-
-	-
-	-
-	-
1111 1101	253/256
1111 1110	254/256
1111 1111	255/256

(3) PWM input / output signal relationship:

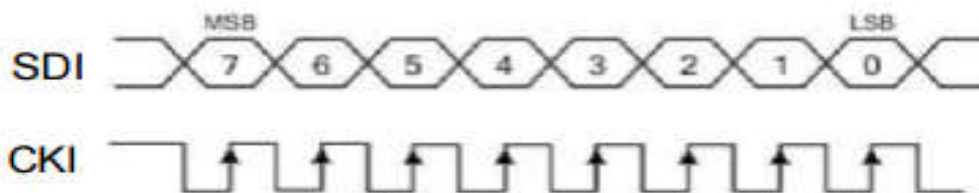

(4) 5-Bit (level 32) brightness adjustment (simultaneous control of OUTR\OUTG\OUTB three port current):

Data	Driving Current
MSB.....LSB	
00000	0/31
00001	1/31
00010	2/31
-	-
-	-
-	-
-	-
11101	29/31
11110	30/31
11111	31/31

(5) Refresh Rate :

Frame rate (=1/ (64+ (32* points)) *CKI (cycle) unit: frames per second)

Such as: 1024 points, CKI frequency is 1MHZ, is =30 frames per second frame rate.

Voron

12. The typical application circuit:

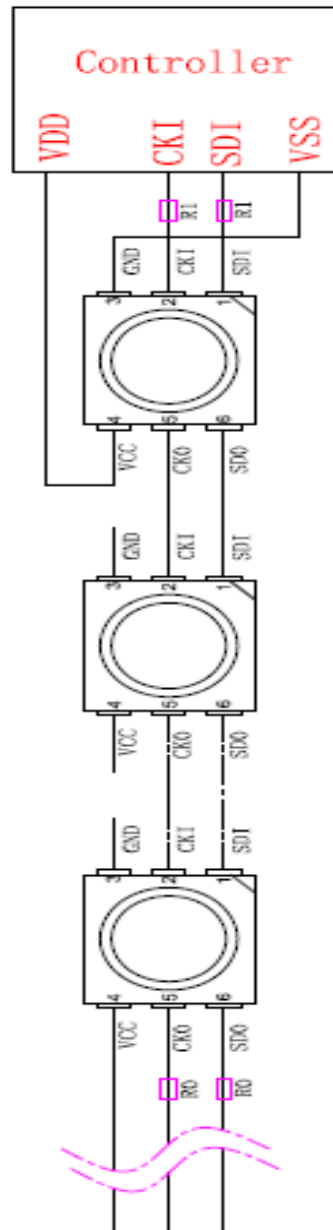

In the practical application circuit, the signal input and output pins of the IC signal input and output pins should be connected to the signal input and output terminals. In addition, in order to make the IC chip is more stable, even the capacitance between beads is essential back;

Application: used for soft lamp strip or hard light, lamp beads transmission distance is short, suggested in signal in time the clock line input and output end of each connected in series protection resistors, $R1=R0$ of about 500 ohms.

Application: for module or general special-shaped products, lamp beads transmission distance is long, because of different wire and transmission distance, in the signal in time clock at both ends of the line on grounding protection resistance will be slightly different; to the actual use of fixed;

Voron

13. Standard LED Performance Graph:

Thermal Pad Temperature vs. Relative Light Output

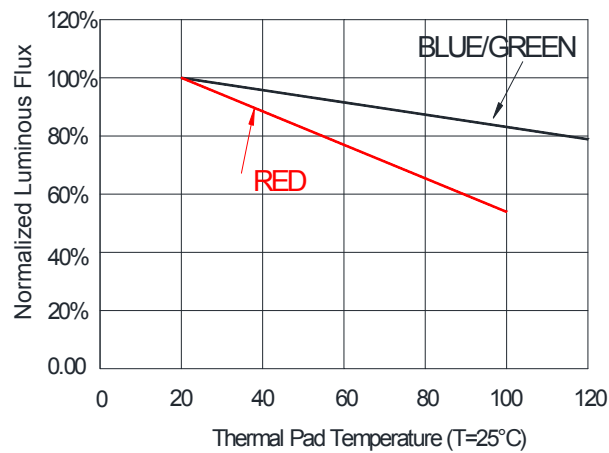

Wavelength Characteristics

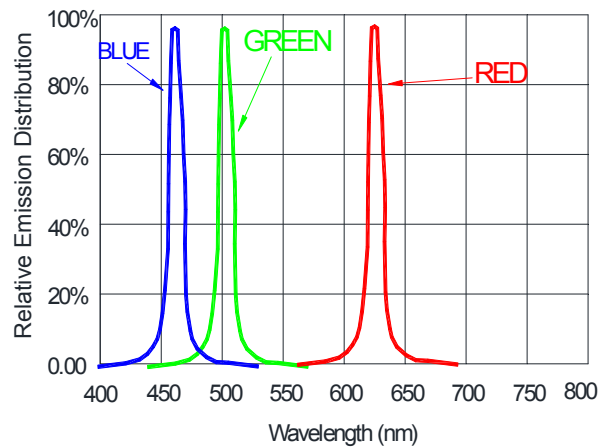

Typical Radiation Pattern 120°

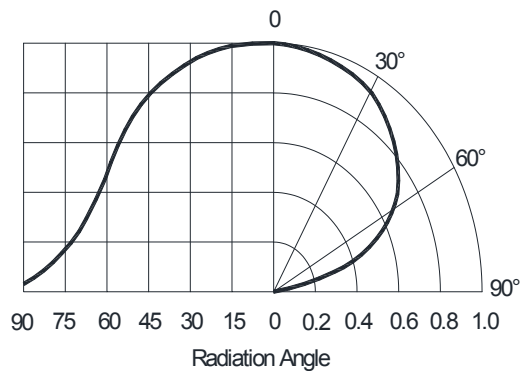

Voron

14. Packaging Standard:

SK9822

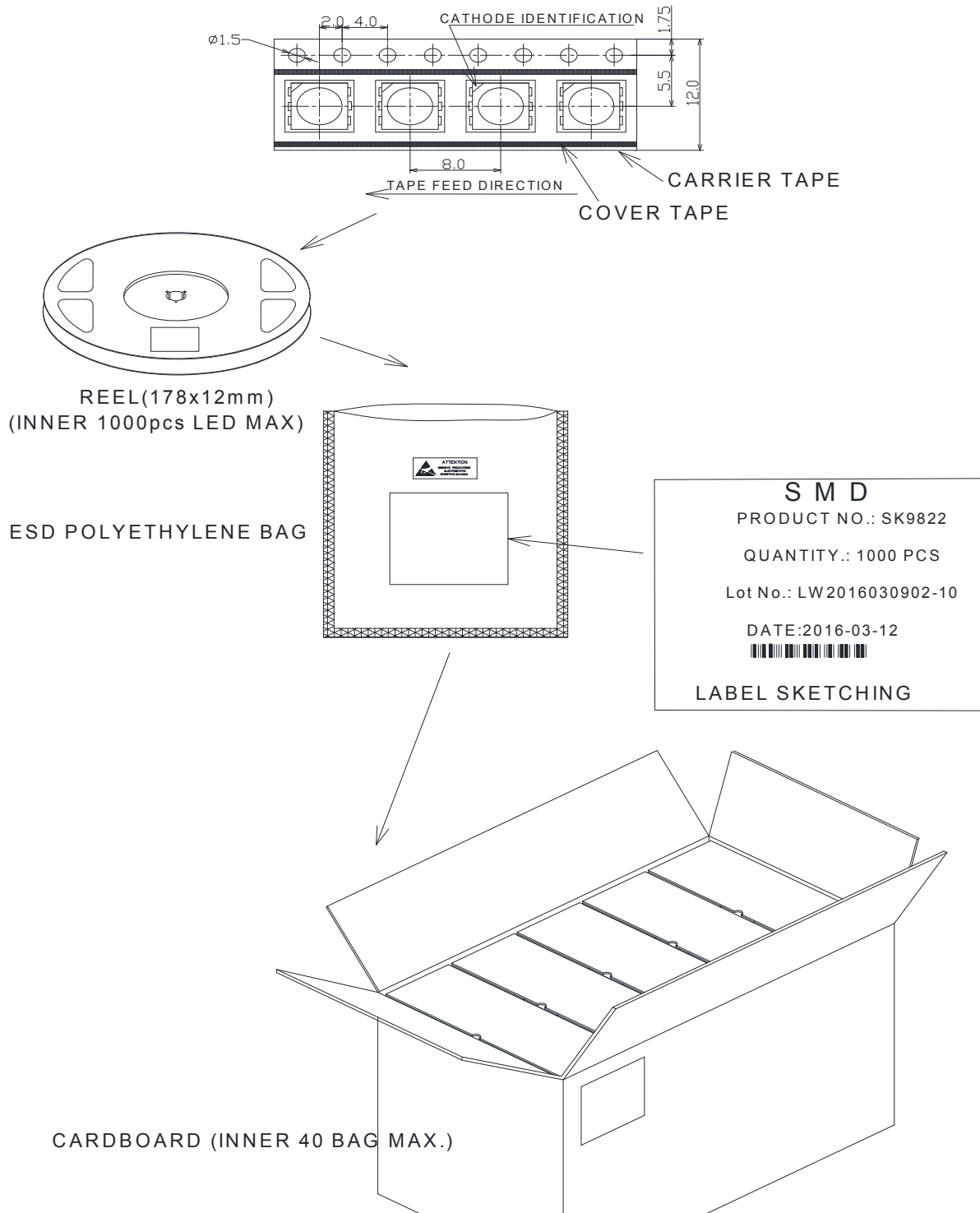

The reel pack is applied in SMD LED. The LEDs are packed in cardboard boxes after packaging in normal or anti-electrostatic bags. cardboard boxes will be used to protect the LEDs from mechanical shocks during transportation. The boxes are not water resistant and therefore must be kept away from water and moisture.

Voron

15. Reliability Test :

NO.	Test item	Test Conditions	Reference	Criterion
1	Thermal Shock	100 ± 5° C ~ -40° C ± 5° C 30min~30min 300 cycles	MIL-STD-202G	0/22
2	High Temperature Storage	Ta= +100° C 1000hrs	JEITA ED-4701 200 201	0/22
3	Low Temperature Storage	Ta= -40° C 1000hrs	JEITA ED-4701 200 202	0/22
4	High Temperature High Humidity Storage	Ta=60° C RH=90% 1000hrs	JEITA ED-4701 100 103	0/22
5	Temperature Cycle	-55° C~25° C~100° C~25° C 30min~5min~30min~5min 100 cycles	JEITA ED-4701 100 105	0/22
6	Resistance to Soldering Heat	Tsld = 260° C, 10sec. 3 times	JEITA ED-4701 300 301	0/22
7	Room temp Life Test	25° C, IF: Typical current , 1000hrs	JESD22-A 108D	0/22

Criteria for Judging the Damage:

Item	Symbol	Test Condition	Limit	
			Min	Max
Luminous Intensity	IV	DC=5V, Typical current	Init. Value*0.7	---
Resistance to Soldering Heat	---	DC=5V, Typical current	No dead lights or obvious damage	

APPENDIX 1.TOP SMD LED Application Notes

1. Features

The Purposes of making Normand's customers and users to have a clear understanding on the ways how to use the LED.

2. Description

Generally. The LED can be used the same way as other general purposed semiconductors. When using Normand's TOP SMD LED, the following precautions must be taken to protect the LED.

3. Cautions

3.1. Dust & Cleaning

This emitter has a silicone surface, There are many benefits to the silicone surface in terms of optical properties and improved reliability. However, silicone is a softer material and prone to attract dust. While a minimal amount of dust and debris on the LED will not cause significant reduction in illumination, steps should be taken to keep the emitter free of dust.

These include keeping the LEDs in the manufacturer's package prior to assembly and storing assemblies in an enclosed area after installing the emitters.

Surface condition of this device may change when organic solvents such as trichloroethylene or acetone were applied.

Avoid using organic solvent, it is recommended that isopropyl be used as a solvent for cleaning the LEDs. When using other solvents, it should be confirmed beforehand whether the solvents will dissolve the package and the resin or not.

Do not clean the LEDs by the ultrasonic. When it is absolutely necessary, the influence as ultrasonic cleaning on the LEDs depends on factors such as ultrasonic power. Baking time and assembled condition. Before cleaning, a pre-test should be done to confirm whether any damage to the LEDs will occur.

3.2. Shipment and storage

TOP SMD LED is a humidity sensor, the LED packaging in the aluminum bag is to avoid the LED in the transport and storage of moisture absorption, in the bag with a desiccant to absorb the moisture inside the bag. If the LED absorbs water vapor, then in the LED over reflow, in the high temperature state, into which the rapid expansion of gas vaporization and produce a greater internal stress, so that the material crack, layered or damaged bonding wire , Resulting in product failure.

TOP SMD LED with a moisture-proof anti-static aluminum foil bag packaging, handling should avoid the process of squeezing, piercing the case of bags, and do the necessary anti-static protective measures; promise products on the line before the leak or broken, Please stop the use of direct use of the product; , Resulting in product failure;

Such as before the material has been found to prevent moisture-proof aluminum foil bags have been opened, damaged, perforated can be returned to the original re-dehumidification, must not be on-line use;

The humidity level of this product is LEVEL5a.

Chart 1: Definition of material's MSL prescribed by IPC/JEDECJ-STD-020E

Moisture proof	Workshop lifespan after open the packaging	
	Time	condition
LEVEL1	unlimited	≤30°C/85 % RH
LEVEL2	1 year	≤30°C/60 % RH
LEVEL2a	4 Weeks	≤30°C/60 % RH
LEVEL3	168 Hours	≤30°C/60 % RH
LEVEL4	72 Hours	≤30°C/60 % RH
LEVEL5	48 Hours	≤30°C/60 % RH
LEVEL5a	24 Hours	≤30°C/60 % RH
LEVEL6	Take off and use immediately	≤30°C/60 % RH

3.3. Storage before unsealing

In order to avoid the moisture barrier caused by the reliability of the failure problem, need to do LED products SMT pre-storage and moisture-proof measures;

If the moisture-proof bag is not open, the TOP SMD element will be stored for less than 2 months at <30 ° C / 60% RH; (Note: The label date is the same and the packing is not leaked. Discoloration under the premise of use; for different moisture-proof grade materials or packaging to save the time there is a certain difference, the specific preservation time to the specification book or packaging tips prevail); recommended in the unassembled do not open the moisture before the bag;

3.4. Control after the packing bag is opened

After opening the moisture-proof bag, please read the moisture-proof bag inside the humidity indicator card in the moisture-proof beads into pink to confirm moisture in the moisture bag is too much, according to the color of the ball to determine whether the bag material on-line operation; And the material after opening the package should be strictly controlled in the table 1 as specified by the maximum temperature and humidity and operating time allowed, as long as the material exposed in the environment described in Table 1, the need to accumulate its use in the workshop time. Open the bag and paste the material on the PCB board, should be completed within 0.5H welding work, do not recommend the material attached to the PCB, a long time stay in the workshop does not carry out SMT work; Caused by adverse water within the lead;

3.5. Definition of humidity card

Open the package after the TOP SMD LED bag inside the humidity card color instructions are as follows:

- A. If the moisture card 10% of the moisture-proof beads into pink, other files for the blue, this situation, LED can be used directly;
- B. If the humidity card moisture-proof beads 10%, 20% at all become pink, in fact, the file is blue, this situation, the need for low-temperature components dehumidification;
- C. If the humidity card moisture-proof beads 10%, 20%, 30% more than three are turned pink, in this case, the customer needs to return the material to our company for high humidity dehumidification, re-packaging before use;

Voron

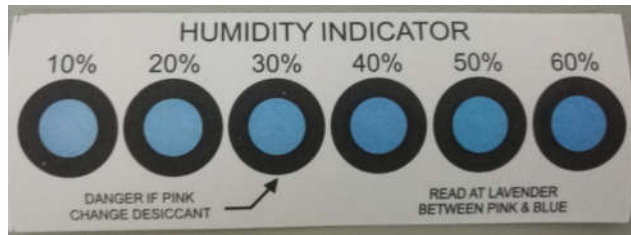

Humidity indicator DO not change color

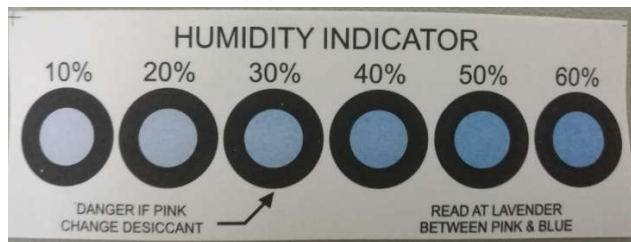

Humidity indicator tums pink in 10% 20%

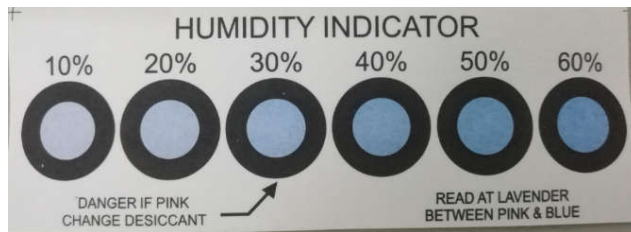

Humidity indicator tums pink in 10% 20% 30%

3.6. Unwanted material moisture-proof storage and moisture-proof control of finished material

If a roll of SMDs is not used at once and the plant temperature and humidity are within the defined conditions ($<30^{\circ}\text{C}$ / 60% RH), the exposure time of the element in the air does not exceed 2H, the remaining material should be carried out together with the desiccant Vacuum sealed, otherwise, the material must be low-wet baking dehumidification; dehumidified material can be re-packaged to re-start the calculation time;

Perform moisture control on SMDs components that have been assembled

- After the components have been assembled to the PCB board no longer need to go through the high temperature process or reflow process, it will not be special treatment;
- Do not need to do the necessary dehumidification work before making the appropriate protection process, bake in $70^{\circ}\text{C} \pm 5^{\circ}\text{C}$ oven baking for less than 12 hours, To remove the product in the detection and aging process exposed to moisture in the air to avoid the product in the protective treatment, the package in the material surface of the moisture will slowly invade the product, will cause product failure;
- For products that require secondary SMT process or high temperature, they should be subjected to the necessary moisture treatment before secondary welding, after exposure to ($<30^{\circ}\text{C}$ / 60% RH) , The maximum length of not more than 2H, Connaught second high temperature process separated by a long time, then a welding material must be necessary dehumidification work ($70^{\circ}\text{C} \pm 5^{\circ}\text{C}$ oven baking no less than 12 hours), and then pumping Vacuum storage; or the first product stored in the oven or with a desiccant container, the second high-temperature process before doing dehumidification work ($70^{\circ}\text{C} \pm 5^{\circ}\text{C}$ in the oven baking no less than 12 hours) , To ensure that products in the high temperature before the process is not damp;

Low-temperature baking conditions: $70^{\circ}\text{C} \pm 5^{\circ}\text{C}$ baking not less than 12 hours high temperature baking conditions: $130^{\circ}\text{C} \pm 5^{\circ}\text{C}$ baking not less than 6 hours (lamp beads must be split into particles)

Voron

3.7. Reflow Soldering Characteristics

In testing, Normand has found S50 LEDs to be compatible with JEDEC J-STD-020E, using the parameters listed below. As a general guideline Normand recommends that users follow the recommended soldering profile provided by the manufacturer of solder paste used.

Note that this general guideline is offered as a starting point and may require adjustment for certain PCB designs and Configurations of reflow soldering equipment.

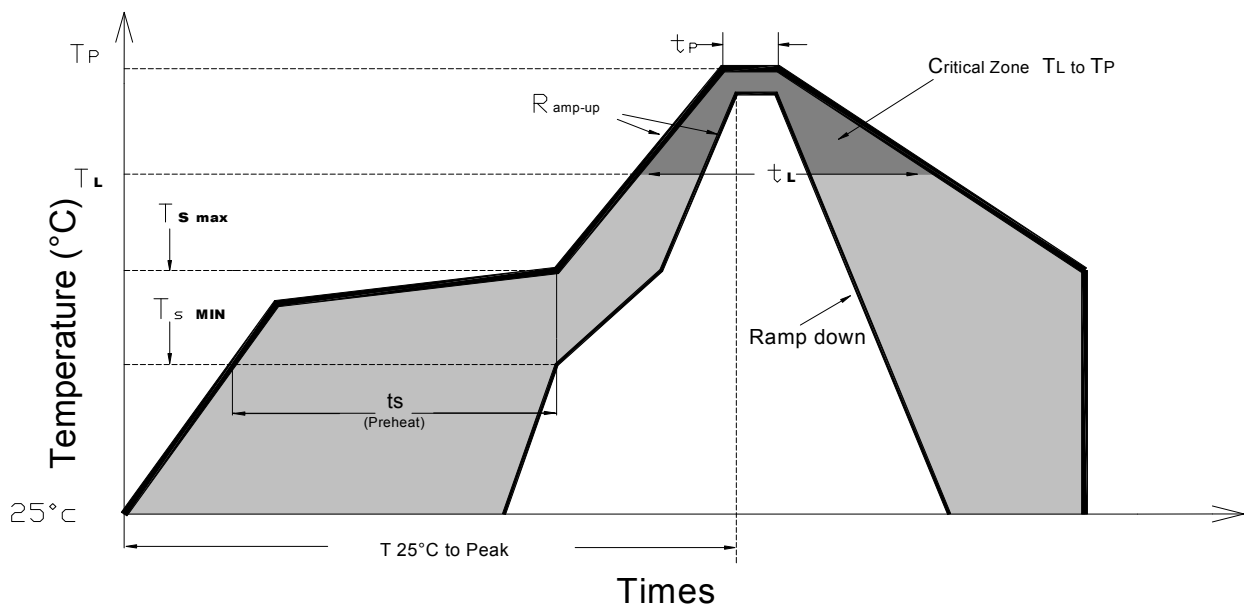

Profile Feature	Lead-Based Solder	Lead-Free Solder
Average Ramp-Up Rate ($T_{s \max}$ to T_p)	3°C/second max.	3°C/second max.
Preheat: Temperature Min ($T_{s \min}$)	100°C	150°C
Preheat: Temperature Min ($T_{s \max}$)	150°C	200°C
Preheat: Time ($t_{s \min}$ to $t_{s \max}$)	60-120 seconds	60-180 seconds
Time Maintained Above: Temperature (T_l)	183 °C	217 °C
Time Maintained Above: Time (t_l)	60-150 seconds	60-150 seconds
Peak/Classification Temperature (T_p)	215 °C	240 °C
Time Within 5°C of Actual Peak Temperature (t_p)	<10 seconds	<10 seconds
Ramp-Down Rate	6°C/second max.	6°C/second max.
Time 25 °C to Peak Temperature	<6 minutes max.	<6 minutes max.

Note: All temperatures refer to topside of the package, measured on the package body surface.

Voron

3.8 General design requirements :

. SMT nozzle requirements: (red circle refers to the nozzle diameter)

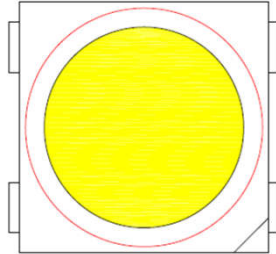

OK (nozzle diameter is greater than the light bulb area)

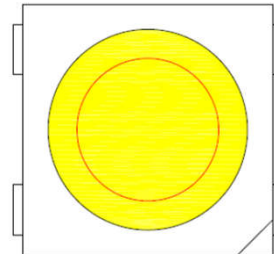

NG (nozzle diameter is less than the light beads light area)

- . Material to take way: with tweezers folder material, can not press the colloid or sharp objects to touch the colloid, the material can not be stacked;

a. Correct handling

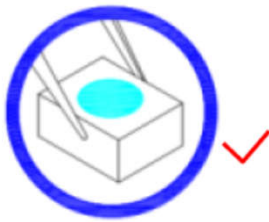

b. Wrong handling and wrong display after assembling

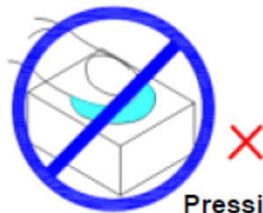

Pressing gels

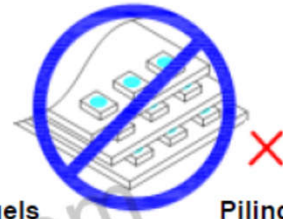

Piling up material

- . Products in the PCB layout design, for the soft sheet, and 0.5T below the plate, the pad direction should be perpendicular to the direction of PCB extension to reduce the PCB board bending stress generated in the LED pin, resulting in LED products Due to stress acting tensile failure;

3.9 Heat Generation:

Thermal design of the end product is of paramount importance. Please consider the heat generation of the LED when making the system design. The coefficient of temperature increase per input electric power is affected by the thermal resistance of the circuit board and density of LED placement on the board, as well as components. It is necessary to avoid in tense heat generation and operate within the maximum rating given in this specification. The operating current should be decided after considering the ambient maximum temperature of LEDs

The maximum working temperature of the product is not easy to exceed 40 ° C (≤ 40 ° C, refers to the product pin at the operating temperature)

4.0 Electrostatic Discharge & Surge Current :

Electrostatic discharge (ESD) or surge current (EOS) may damage LED.

Precautions such as ESD wrist strap, ESD shoe strap or antistatic gloves must be worn whenever handling of LED.

IC device signal input and output ports must be connected in series protection resistor to prevent surge or static shock port caused by product failure;

All devices, equipment and machinery must be properly grounded.

It is recommended to perform electrical test to screen out ESD failures at final inspection.

It is important to eliminate the possibility of surge current during circuitry design.

4.1 Moisture Proof Package

Cannot take any responsibility for any trouble that are caused by using the LEDs at conditions exceeding our specifications.

The LED light output is strong enough to injure human eyes. Precautions must be taken to prevent looking directly at the LEDs with unaided eyes for more than a few seconds.

The formal specification must be exchanged and signed by both parties before large volume purchase begins.

The appearance and specifications of the product may be modified for improvement without notice.