

Specifications of Seven segment LED display

Part: KL-15011-BSR

Features:

Digit height	1.5"	Epoxy color	Milky white
Digit quantity	One	Pin configuration	Common anode
Surface color	Black	Emitting color	Super red

Package dimension& Internal circuit diagram

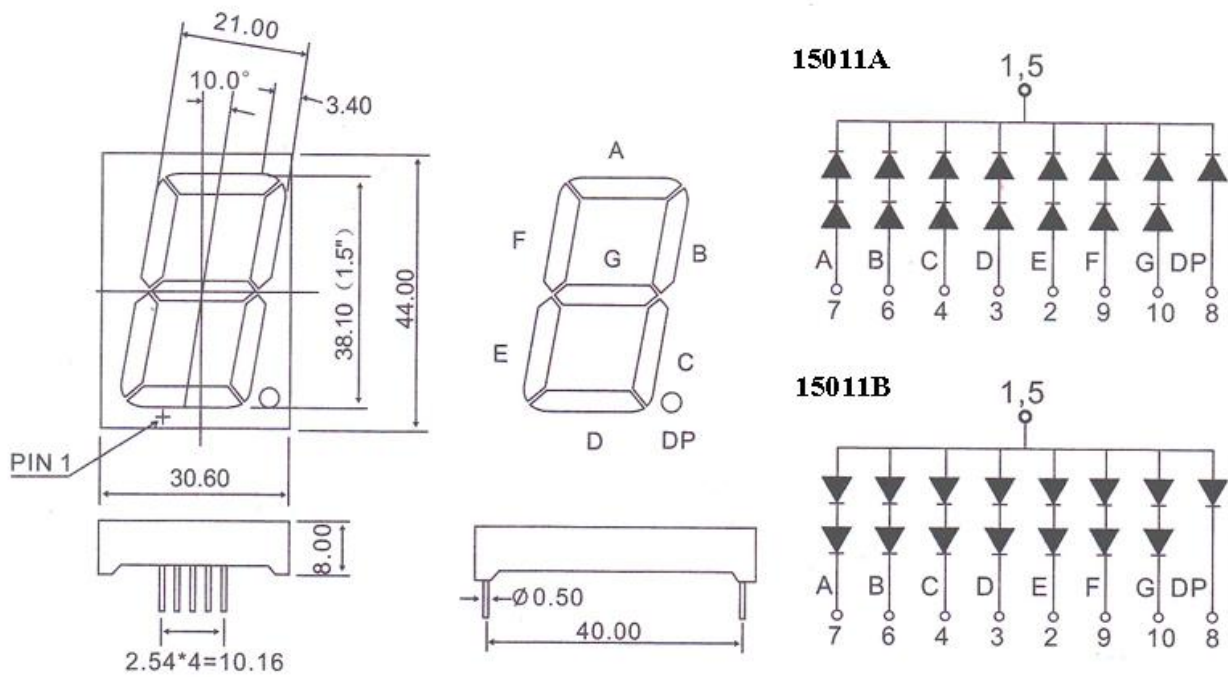

Notes:

- . All dimensions are in millimeters (inches).
- . Tolerance is 0.25(0.01) unless otherwise noted.
- . Specifications are subject to change without notice.

☆ABSOLUTE MAXIMUM RATINGS (Ta=25℃)

ITEM	Amber	Super green	Super red	High red	Yellow green	Yellow	Blue	Pure green	White	UNIT
Power Dissipation (Pd)	52	50	40	36	44	42	66	66	66	mW
Peak Forward Current (Ifp)	100	100	100	100	100	100	100	100	100	mA
Continuous Forward Current(If)	20	20	20	20	20	20	20	20	20	mA
Reverse Voltage (Vr)	5	5	5	5	5	5	5	5	5	V
Reverse Current(Ir)	20	20	20	20	20	20	20	20	20	Ua
Operating Temperature Range(Ta)	-35~+85									℃
Storage Temperature Range(Tstg)	-35~+85									℃
Lead Solder Temperature	260℃ for 3 sec									

☆ Color Code & Chip characteristic: (Test Condition: IF=20Ma)

Emitting Color	Peak Wavelength		Forward Voltage IF=20Ma (V)		Luminous Intensity IF=20Ma(mcd)
	(λp)	△λ	Typ	Max	Max
Amber	605-615	30	1.9	2.1	30
Super green	565-575	30	1.9	2.1	80
Super red	625-640	20	1.9	2.1	100
High red	640-660	20	1.9	2.1	20
Yellow green	570-580	30	1.9	2.1	12
Yellow	590-600	35	1.9	2.1	60
Blue	465-475	40	3.1	3.3	50
Pure green	515-525	40	3.1	3.3	200
White			3.1	3.3	180