

- 7 A Continuous Collector Current
- 15 A Peak Collector Current
- 60 W at 25°C Case Temperature

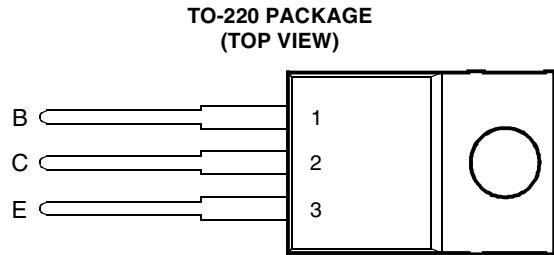

Pin 2 is in electrical contact with the mounting base.

MDTRACA

**absolute maximum ratings at 25°C case temperature (unless otherwise noted)**

RATING		SYMBOL	VALUE	UNIT
Collector-base voltage ( $I_E = 0$ )	BU406 BU407	$V_{CB0}$	400 330	V
Collector-emitter voltage ( $V_{BE} = -2$ V)	BU406 BU407	$V_{CEX}$	400 330	V
Collector-emitter voltage ( $I_B = 0$ )	BU406 BU407	$V_{CEO}$	200 150	V
Emitter-base voltage		$V_{EB}$	6	V
Continuous collector current		$I_C$	7	A
Peak collector current (see Note 1)		$I_{CM}$	15	A
Continuous base current		$I_B$	4	A
Continuous device dissipation at (or below) 25°C case temperature		$P_{tot}$	60	W
Operating junction temperature range		$T_j$	-55 to +150	°C
Storage temperature range		$T_{stg}$	-55 to +150	°C

NOTE 1: This value applies for  $t_p \leq 10$  ms, duty cycle  $\leq 2\%$ .

**PRODUCT INFORMATION**

**electrical characteristics at 25°C case temperature (unless otherwise noted)**

PARAMETER	TEST CONDITIONS	MIN	TYP	MAX	UNIT
$V_{(BR)CEO}$ Collector-emitter breakdown voltage	$I_C = 30 \text{ mA}$ $I_B = 0$	140			V
$I_{CES}$ Collector-emitter cut-off current	$V_{CE} = 400 \text{ V}$ $V_{BE} = 0$ BU406			5	mA
	$V_{CE} = 330 \text{ V}$ $V_{BE} = 0$ BU407			5	
	$V_{CE} = 250 \text{ V}$ $V_{BE} = 0$ BU406			0.1	
	$V_{CE} = 200 \text{ V}$ $V_{BE} = 0$ BU407			0.1	
	$V_{CE} = 250 \text{ V}$ $V_{BE} = 0$ $T_C = 150^\circ\text{C}$ BU406			1	
	$V_{CE} = 200 \text{ V}$ $V_{BE} = 0$ $T_C = 150^\circ\text{C}$ BU407			1	
$I_{EBO}$ Emitter cut-off current	$V_{EB} = 6 \text{ V}$ $I_C = 0$			1	mA
$h_{FE}$ Forward current transfer ratio	$V_{CE} = 10 \text{ V}$ $I_C = 4 \text{ A}$ (see Notes 2 and 3)	12			
	$V_{CE} = 10 \text{ V}$ $I_C = 0.5 \text{ A}$	20			
$V_{CE(sat)}$ Collector-emitter saturation voltage	$I_B = 0.5 \text{ A}$ $I_C = 5 \text{ A}$ (see Notes 2 and 3)			1	V
$V_{BE(sat)}$ Base-emitter saturation voltage	$I_B = 0.5 \text{ A}$ $I_C = 5 \text{ A}$ (see Notes 2 and 3)			1.2	V
$f_t$ Current gain bandwidth product	$V_{CE} = 5 \text{ V}$ $I_C = 0.5 \text{ A}$ $f = 1 \text{ MHz}$ (see Note 4)		6		MHz
$C_{ob}$ Output capacitance	$V_{CB} = 20 \text{ V}$ $I_E = 0$ $f = 1 \text{ MHz}$		60		pF

- NOTES: 2. These parameters must be measured using pulse techniques,  $t_p = 300 \mu\text{s}$ , duty cycle  $\leq 2\%$ .  
3. These parameters must be measured using voltage-sensing contacts, separate from the current carrying contacts.  
4. To obtain  $f_t$  the  $[h_{FE}]$  response is extrapolated at the rate of -6 dB per octave from  $f = 1 \text{ MHz}$  to the frequency at which  $[h_{FE}] = 1$ .

**thermal characteristics**

PARAMETER	MIN	TYP	MAX	UNIT
$R_{\theta JC}$ Junction to case thermal resistance			2.08	$^\circ\text{C/W}$
$R_{\theta JA}$ Junction to free air thermal resistance			70	$^\circ\text{C/W}$

**inductive-load-switching characteristics at 25°C case temperature (unless otherwise noted)**

PARAMETER	TEST CONDITIONS †	MIN	TYP	MAX	UNIT
$t_s$ Storage time	$I_C = 5 \text{ A}$ $I_{B(end)} = 0.5\text{A}$ (see Figures 1 and 2)		2.7		$\mu\text{s}$
$t_{(off)}$ Turn off time				750	ns

† Voltage and current values shown are nominal; exact values vary slightly with transistor parameters.

**PARAMETER MEASUREMENT INFORMATION**

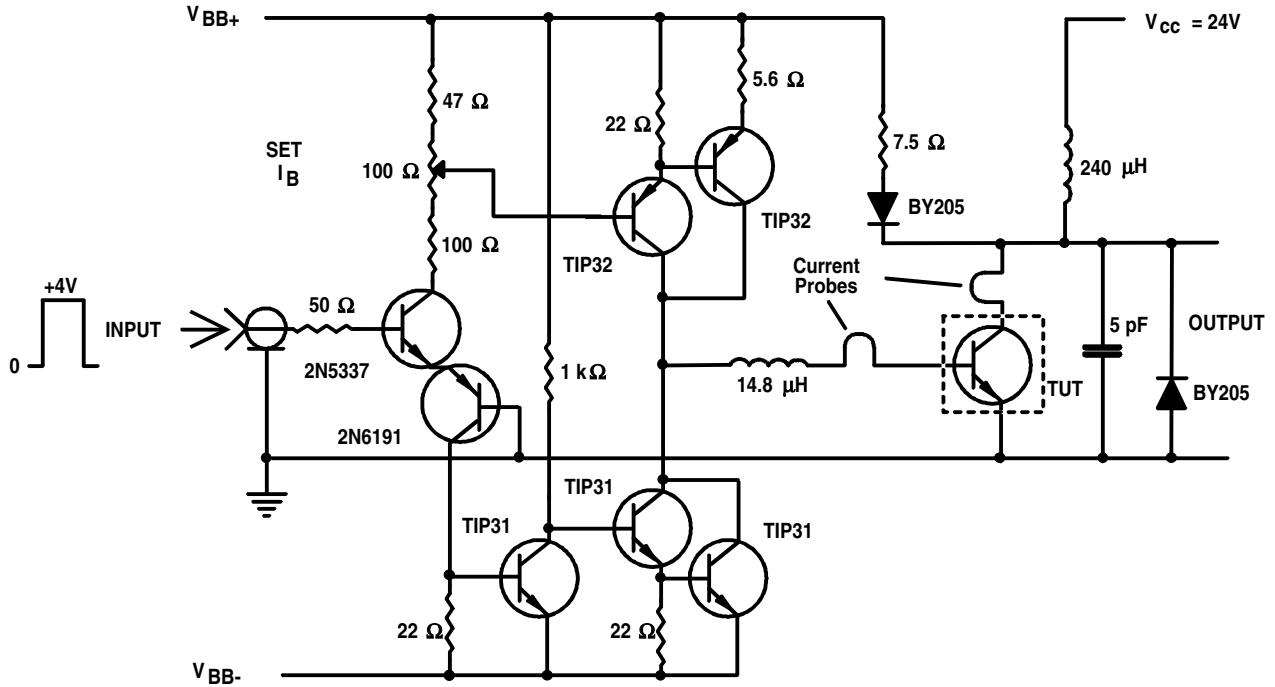

**Figure 1. Inductive-Load Switching Test Circuit**

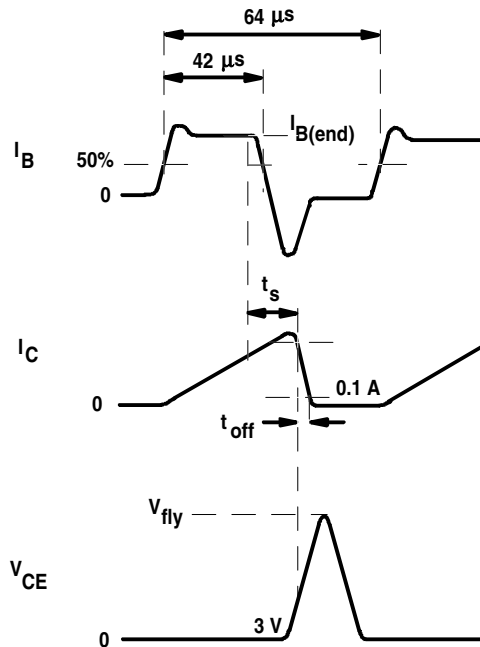

$t_{off}$  is the time for the collector current  $I_C$  to decrease to 0.1 A after the collector to emitter voltage  $V_{CE}$  has risen 3 V into its flyback excursion.

**Figure 2. Inductive-Load Switching Waveforms**

**PRODUCT INFORMATION**

AUGUST 1978 - REVISED SEPTEMBER 2002  
Specifications are subject to change without notice.

TYPICAL CHARACTERISTICS

TYPICAL DC CURRENT GAIN  
VS  
COLLECTOR CURRENT

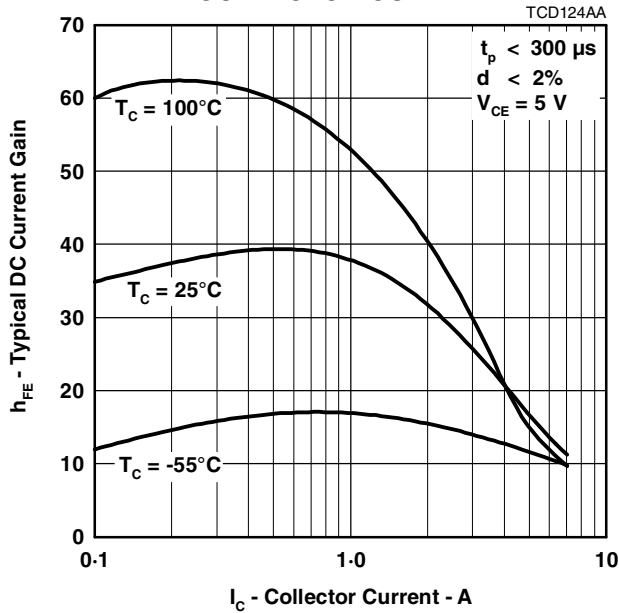

Figure 3.

TYPICAL DC CURRENT GAIN  
VS  
COLLECTOR CURRENT

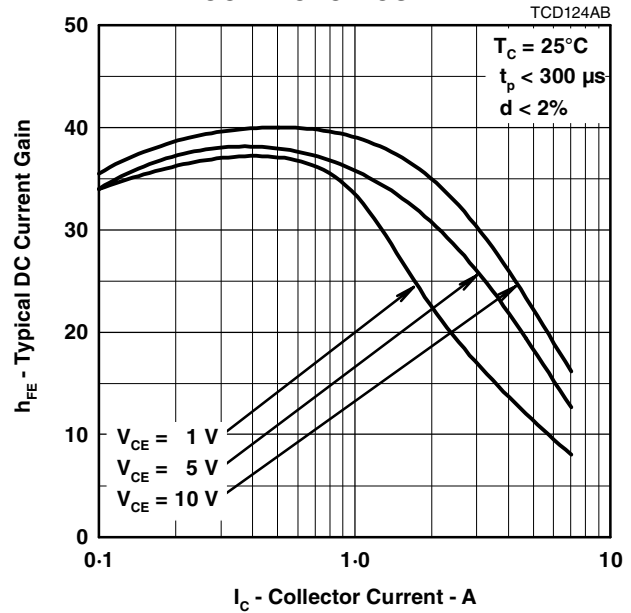

Figure 4.

COLLECTOR-EMITTER SATURATION VOLTAGE  
VS  
CASE TEMPERATURE

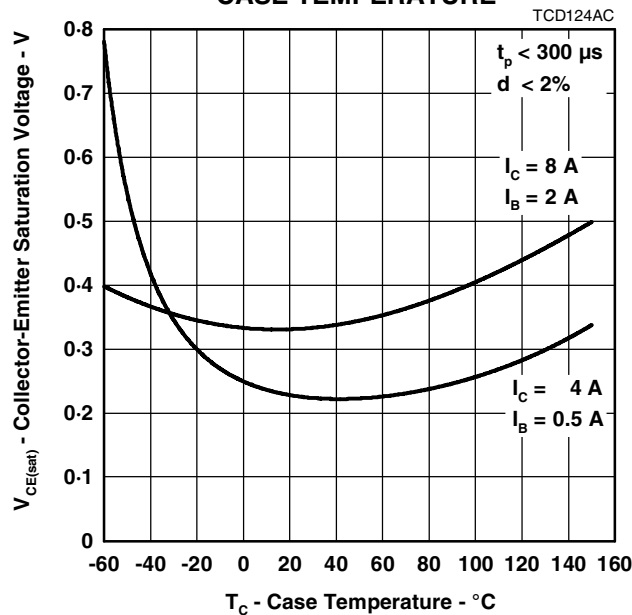
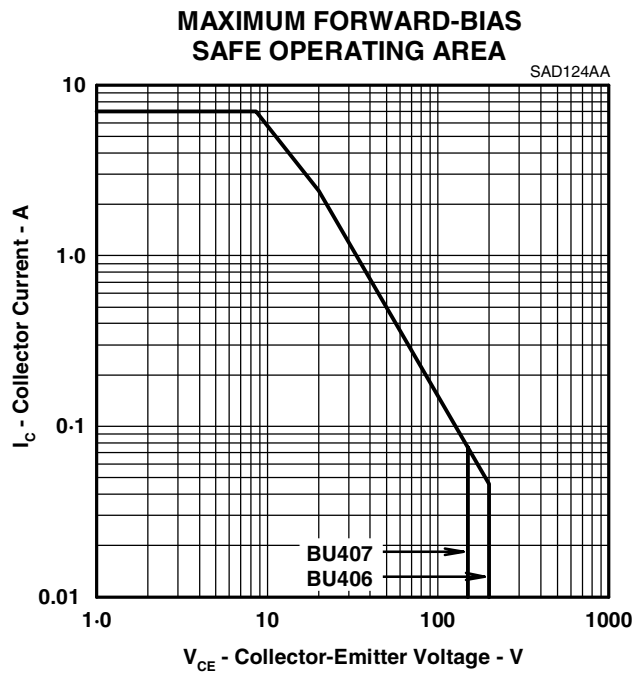

Figure 5.

**PRODUCT INFORMATION**

**MAXIMUM SAFE OPERATING REGIONS**



**Figure 6.**

**PRODUCT INFORMATION**

AUGUST 1978 - REVISED SEPTEMBER 2002  
Specifications are subject to change without notice.

# Mouser Electronics

Authorized Distributor

Click to View Pricing, Inventory, Delivery & Lifecycle Information:

[Bourns:](#)

[BU406-S](#)