

50V N-CHANNEL ENHANCEMENT MODE VERTICAL DMOS FET IN SOT23

Features and Benefits

- $BV_{DSS} > 50V$
- $R_{DS(on)} \leq 3.5\Omega @ V_{GS} = 5V$
- Maximum continuous drain current $I_D = 200mA$
- "Lead Free", RoHS Compliant (Note 1)
- Halogen and Antimony Free. "Green" Device (Note 2)
- Qualified to AEC-Q101 Standards for High Reliability

Mechanical Data

- Case: SOT-23
- Case Material: Molded Plastic, "Green" Molding Compound. UL Flammability Classification Rating 94V-0
- Moisture Sensitivity: Level 1 per J-STD-020
- Terminals: Matt Tin Finish; Solderable per MIL-STD-202, Method 208
- Weight: 0.008 grams (approximate)

SOT-23



Top View

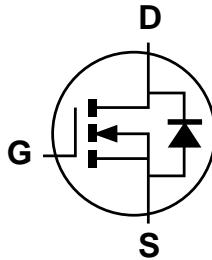

Device symbol

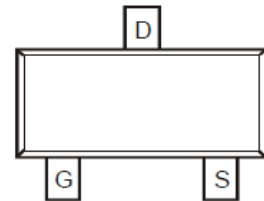

Pin-Out
Top View

Ordering Information (Note 3)

| Part Number | Marking | Reel size (inches) | Tape width (mm) | Quantity per reel |
|-------------|---------|--------------------|-----------------|-------------------|
| BSS138TA | SS | 7 | 8 | 3000 |

- Notes:
1. No purposefully added lead
 2. Diodes Inc's "Green" policy can be found on our website at <http://www.diodes.com>.
 3. For packaging details, go to our website at <http://www.diodes.com>.

Marking Information

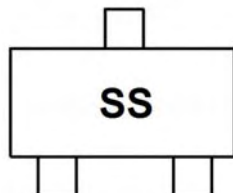

SS = Product Type Marking Code

Maximum Ratings @T_A = 25°C unless otherwise specified

| Characteristic | Symbol | Value | Unit |
|-------------------------------|------------------|-------|------|
| Drain-Source Voltage | V _{DSS} | 50 | V |
| Gate-Source Voltage | V _{GSS} | ±20 | V |
| Continuous Drain Current | I _D | 200 | mA |
| Pulsed Drain Current (Note 5) | I _{DM} | 800 | mA |

Thermal Characteristics @T_A = 25°C unless otherwise specified

| Characteristic | Symbol | Value | Unit |
|--|-----------------------------------|-------------|------|
| Power Dissipation (Note 4) | P _D | 350 | mW |
| Thermal Resistance, Junction to Ambient (Note 4) | R _{θJA} | 357 | °C/W |
| Thermal Resistance, Junction to Leads (Note 6) | R _{θJL} | 195 | °C/W |
| Operating and Storage Temperature Range | T _J , T _{STG} | -55 to +150 | °C |

- Notes:
4. For a device mounted on 25mm X 25mm X 1.6mm FR-4 PCV with high coverage of single sided 1oz copper, in still air condition.
 5. Device mounted on minimum recommended pad layout test board, 10μs pulse duty cycle = 1%.
 6. Thermal resistance from junction to solder-point (at the end of the collector lead).

Thermal Characteristics

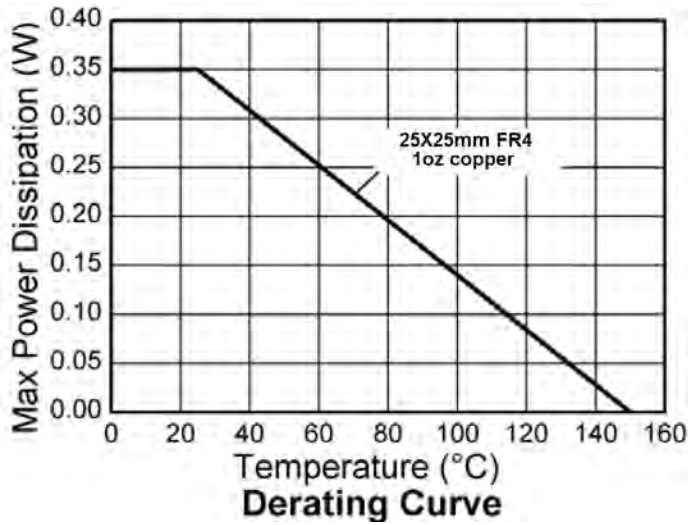
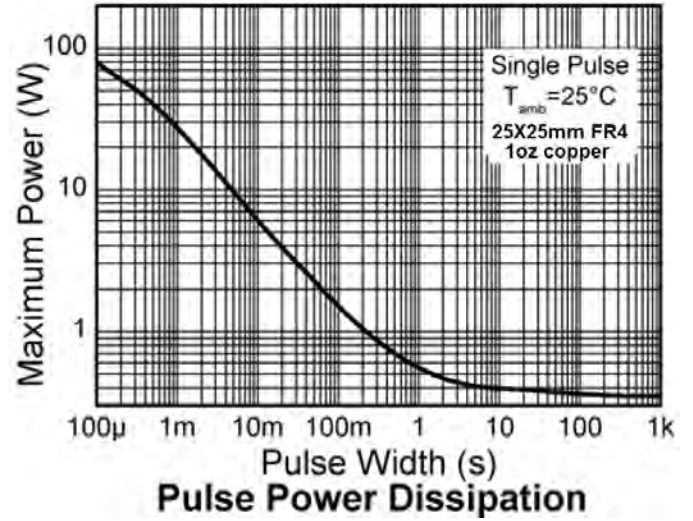
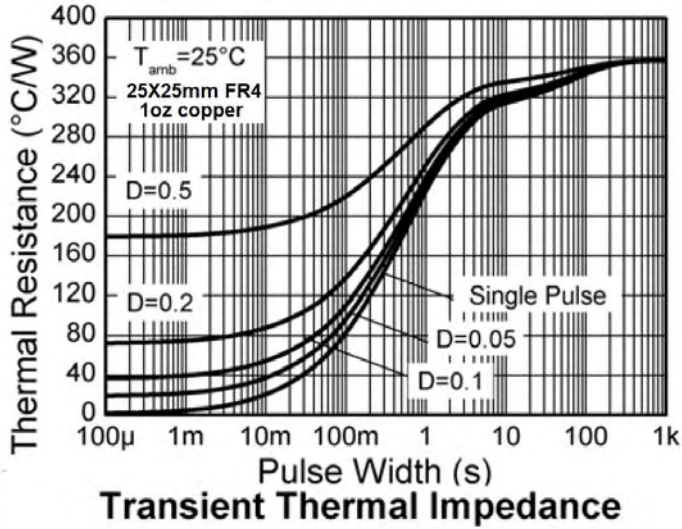

Electrical Characteristics @ $T_A = 25^\circ\text{C}$ unless otherwise specified

| Characteristic | Symbol | Min | Typ | Max | Unit | Test Condition |
|--|--------------|-----|-----|-----------------|--------------------------|--|
| OFF CHARACTERISTICS | | | | | | |
| Drain-Source Breakdown Voltage | BV_{DSS} | 50 | - | - | V | $V_{GS} = 0V, I_D = 0.25mA$ |
| Zero Gate Voltage Drain Current | I_{DSS} | - | - | 0.5 5 100 | μA μA nA | $V_{DS} = 50V, V_{GS} = 0V$ $V_{DS} = 50V, V_{GS} = 0V, T_A = 125^\circ C$ $V_{DS} = 20V, V_{GS} = 0V$ |
| Gate-Source Leakage | I_{GSS} | - | - | ± 100 | nA | $V_{GS} = \pm 20V, V_{DS} = 0V$ |
| ON CHARACTERISTICS | | | | | | |
| Gate Threshold Voltage | $V_{GS(th)}$ | 0.5 | - | 1.5 | V | $V_{DS} = V_{GS}, I_D = 1mA$ |
| Static Drain-Source On-Resistance (Note 7) | $R_{DS(on)}$ | - | - | 3.5 | Ω | $V_{GS} = 5V, I_D = 200mA$ |
| Forward Transconductance (Note 7 & 8) | g_{fs} | 120 | - | - | mS | $V_{DS} = 25V, I_D = 200mA$ |
| DYNAMIC CHARACTERISTICS (Note 8) | | | | | | |
| Input Capacitance | C_{iss} | - | - | 50 | pF | $V_{DS} = 25V, V_{GS} = 0V,$ $f = 1.0MHz$ |
| Output Capacitance | C_{oss} | - | - | 25 | pF | |
| Reverse Transfer Capacitance | C_{rss} | - | - | 8 | pF | |
| Turn-On Delay Time (Note 9) | $t_{D(on)}$ | - | 10 | - | ns | $V_{DD} = 30V, I_D = 280mA$ |
| Turn-On Rise Time (Note 9) | t_r | - | 10 | - | ns | |
| Turn-Off Delay Time (Note 9) | $t_{D(off)}$ | - | 15 | - | ns | |
| Turn-Off Fall Time (Note 9) | t_f | - | 25 | - | ns | |

- Notes:**
- 7. Measured under pulsed conditions. Width = 300 μs . Duty cycle $\leq 2\%$.
 - 8. Sample test.
 - 9. Switching times measured with 50 Ω source impedance and <5ns rise time on a pulse generator.

Electrical Characteristics

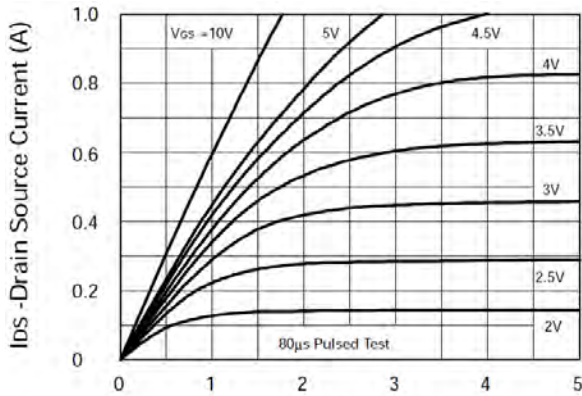

VDS -Drain Source Voltage (Volts)

Saturation Characteristics

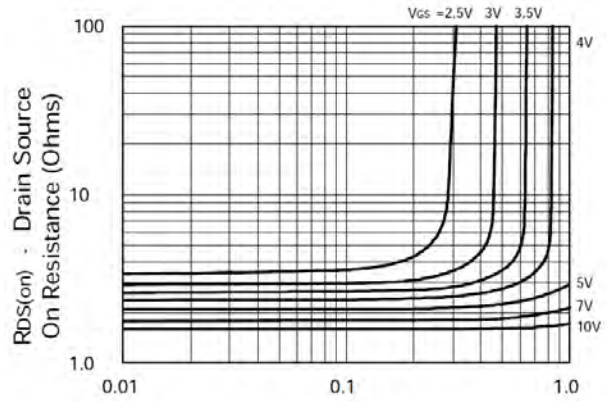

ID-Drain Current (Amperes)

Typical On Resistance vs. Drain Current

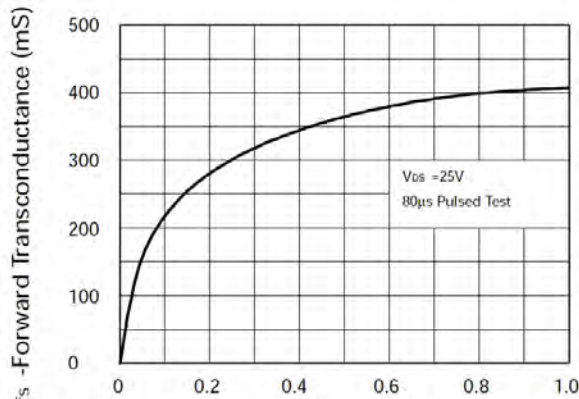

ID-Drain Current (Amperes)

Typical Transconductance vs. Drain Current

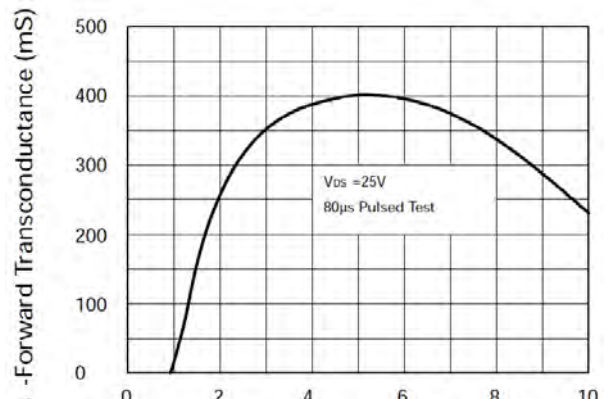

VGS -Gate Source Voltage (Volts)

Typical Transconductance vs. Gate - Source Voltage

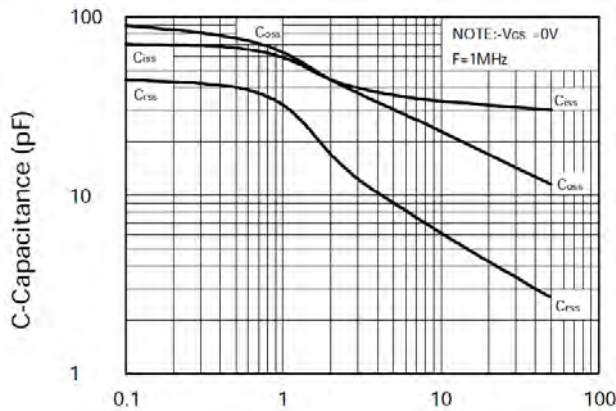

VDS -Drain Source Voltage (Volts)

Typical Capacitance vs. Drain - Source Voltage

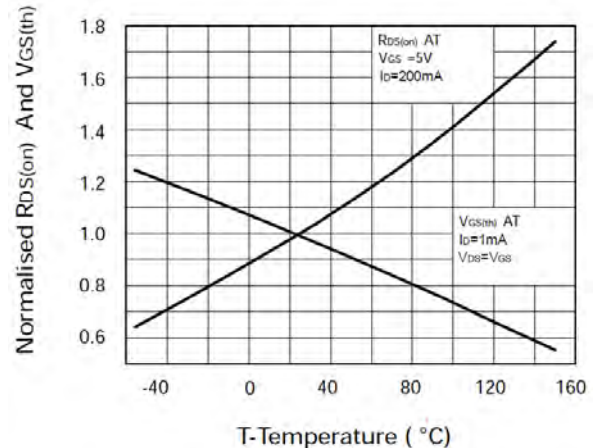

T-Temperature (°C)

Normalised RDS(on) And VGS(th) vs. Temperature

Electrical Characteristics – (Continuous)

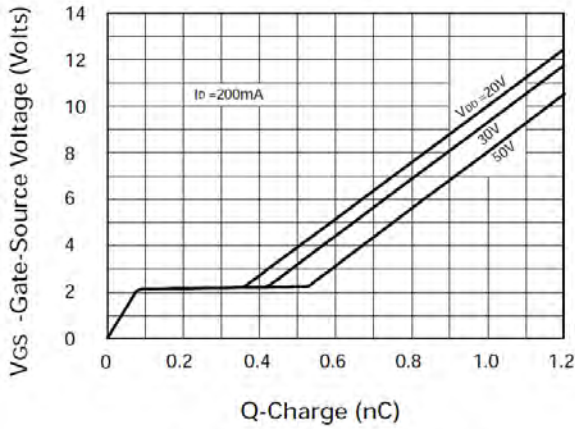

Typical Gate Charge vs. Gate-Source Voltage

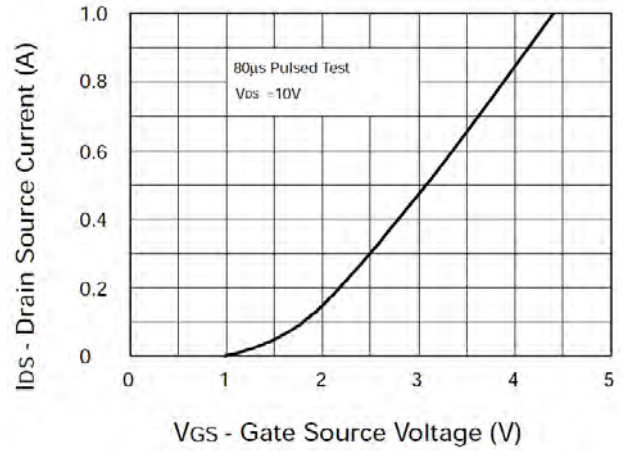

Typical Transfer Characteristics

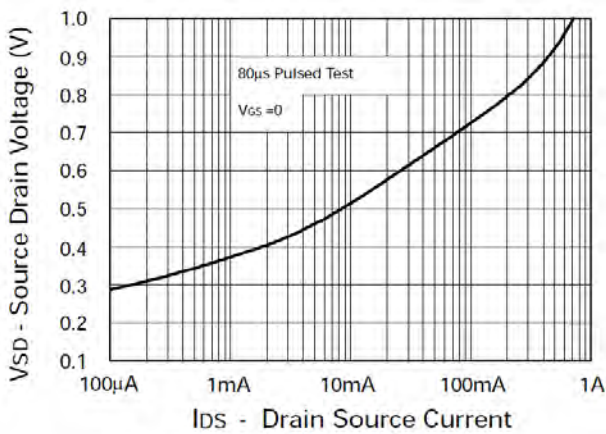

Typical Diode Forward Voltage

Package Outline Dimensions

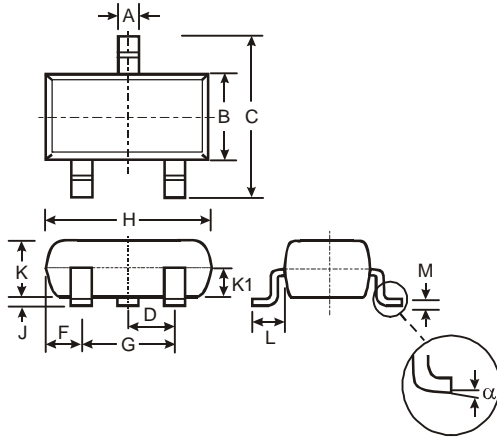

| SOT23 | | | |
|----------------------|-------|------|-------|
| Dim | Min | Max | Typ |
| A | 0.37 | 0.51 | 0.40 |
| B | 1.20 | 1.40 | 1.30 |
| C | 2.30 | 2.50 | 2.40 |
| D | 0.89 | 1.03 | 0.915 |
| F | 0.45 | 0.60 | 0.535 |
| G | 1.78 | 2.05 | 1.83 |
| H | 2.80 | 3.00 | 2.90 |
| J | 0.013 | 0.10 | 0.05 |
| K | 0.903 | 1.10 | 1.00 |
| K1 | - | - | 0.400 |
| L | 0.45 | 0.61 | 0.55 |
| M | 0.085 | 0.18 | 0.11 |
| α | 0° | 8° | - |
| All Dimensions in mm | | | |

Suggested Pad Layout

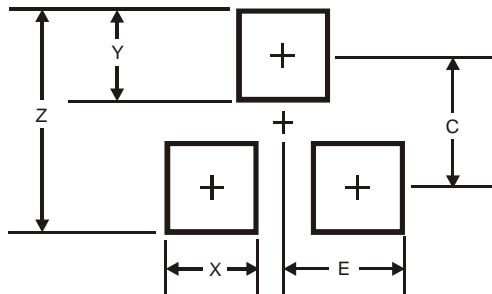

| Dimensions | Value (in mm) |
|------------|---------------|
| Z | 2.9 |
| X | 0.8 |
| Y | 0.9 |
| C | 2.0 |
| E | 1.35 |

IMPORTANT NOTICE

DIODES INCORPORATED MAKES NO WARRANTY OF ANY KIND, EXPRESS OR IMPLIED, WITH REGARDS TO THIS DOCUMENT, INCLUDING, BUT NOT LIMITED TO, THE IMPLIED WARRANTIES OF MERCHANTABILITY AND FITNESS FOR A PARTICULAR PURPOSE (AND THEIR EQUIVALENTS UNDER THE LAWS OF ANY JURISDICTION).

Diodes Incorporated and its subsidiaries reserve the right to make modifications, enhancements, improvements, corrections or other changes without further notice to this document and any product described herein. Diodes Incorporated does not assume any liability arising out of the application or use of this document or any product described herein; neither does Diodes Incorporated convey any license under its patent or trademark rights, nor the rights of others. Any Customer or user of this document or products described herein in such applications shall assume all risks of such use and will agree to hold Diodes Incorporated and all the companies whose products are represented on Diodes Incorporated website, harmless against all damages.

Diodes Incorporated does not warrant or accept any liability whatsoever in respect of any products purchased through unauthorized sales channel. Should Customers purchase or use Diodes Incorporated products for any unintended or unauthorized application, Customers shall indemnify and hold Diodes Incorporated and its representatives harmless against all claims, damages, expenses, and attorney fees arising out of, directly or indirectly, any claim of personal injury or death associated with such unintended or unauthorized application.

Products described herein may be covered by one or more United States, international or foreign patents pending. Product names and markings noted herein may also be covered by one or more United States, international or foreign trademarks.

LIFE SUPPORT

Diodes Incorporated products are specifically not authorized for use as critical components in life support devices or systems without the express written approval of the Chief Executive Officer of Diodes Incorporated. As used herein:

A. Life support devices or systems are devices or systems which:

1. are intended to implant into the body, or
2. support or sustain life and whose failure to perform when properly used in accordance with instructions for use provided in the labeling can be reasonably expected to result in significant injury to the user.

B. A critical component is any component in a life support device or system whose failure to perform can be reasonably expected to cause the failure of the life support device or to affect its safety or effectiveness.

Customers represent that they have all necessary expertise in the safety and regulatory ramifications of their life support devices or systems, and acknowledge and agree that they are solely responsible for all legal, regulatory and safety-related requirements concerning their products and any use of Diodes Incorporated products in such safety-critical, life support devices or systems, notwithstanding any devices- or systems-related information or support that may be provided by Diodes Incorporated. Further, Customers must fully indemnify Diodes Incorporated and its representatives against any damages arising out of the use of Diodes Incorporated products in such safety-critical, life support devices or systems.

Copyright © 2011, Diodes Incorporated

www.diodes.com

Mouser Electronics

Authorized Distributor

Click to View Pricing, Inventory, Delivery & Lifecycle Information:

[Diodes Incorporated:](#)

[BSS138TA](#)