



Is Now Part of



ON Semiconductor®

To learn more about ON Semiconductor, please visit our website at
www.onsemi.com

ON Semiconductor and the ON Semiconductor logo are trademarks of Semiconductor Components Industries, LLC dba ON Semiconductor or its subsidiaries in the United States and/or other countries. ON Semiconductor owns the rights to a number of patents, trademarks, copyrights, trade secrets, and other intellectual property. A listing of ON Semiconductor's product/patent coverage may be accessed at www.onsemi.com/site/pdf/Patent-Marking.pdf. ON Semiconductor reserves the right to make changes without further notice to any products herein. ON Semiconductor makes no warranty, representation or guarantee regarding the suitability of its products for any particular purpose, nor does ON Semiconductor assume any liability arising out of the application or use of any product or circuit, and specifically disclaims any and all liability, including without limitation special, consequential or incidental damages. Buyer is responsible for its products and applications using ON Semiconductor products, including compliance with all laws, regulations and safety requirements or standards, regardless of any support or applications information provided by ON Semiconductor. "Typical" parameters which may be provided in ON Semiconductor data sheets and/or specifications can and do vary in different applications and actual performance may vary over time. All operating parameters, including "Typicals" must be validated for each customer application by customer's technical experts. ON Semiconductor does not convey any license under its patent rights nor the rights of others. ON Semiconductor products are not designed, intended, or authorized for use as a critical component in life support systems or any FDA Class 3 medical devices or medical devices with a same or similar classification in a foreign jurisdiction or any devices intended for implantation in the human body. Should Buyer purchase or use ON Semiconductor products for any such unintended or unauthorized application, Buyer shall indemnify and hold ON Semiconductor and its officers, employees, subsidiaries, affiliates, and distributors harmless against all claims, costs, damages, and expenses, and reasonable attorney fees arising out of, directly or indirectly, any claim of personal injury or death associated with such unintended or unauthorized use, even if such claim alleges that ON Semiconductor was negligent regarding the design or manufacture of the part. ON Semiconductor is an Equal Opportunity/Affirmative Action Employer. This literature is subject to all applicable copyright laws and is not for resale in any manner.

FAN156

Low Voltage Comparator

Features

- Low Supply Current: I_{DD} 6 μ A (Typical)
- Single Power Supply Operation
- Wide Common-Mode Input Voltage Range
- Push-Pull Output Circuit
- Low Input Bias Current
- Internal Hysteresis
- Packaged in MicroPak™ 6

Applications

- Mobile Phones
- Alarm and Security Systems
- Personal Digital Assistants

Description

The FAN156 is a low-power single comparator that typically consumes less than 10 μ A of supply current. It is guaranteed to operate at a low voltage of 1.6 V and is fully operational up to 5.5 V, making it convenient for use in 1.8, 3.0 V, and 5.0 V systems.

The FAN156 has a complementary push-pull P- and N-channel output stage capable of driving a rail-to-rail output swing with a load ranging up to 5.0 mA.

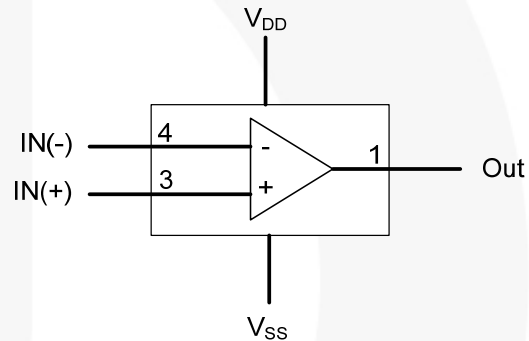

Figure 1. Functional Diagram

Ordering Information

Part Number	Top Mark	Operating Temperature Range	Package	Packing Method
FAN156L6X	CN	-40 to 85°C	6-Lead, MicroPak™, 1 x 1.45 mm Wide	5000 Units on Tape and Reel

Pin Configuration

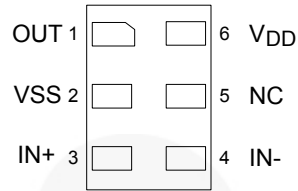

Figure 2. Pin Configuration (Top-Through View)

Pin Definitions

Pin #	Name	Description
1	OUT	Comparator Output
2	V _{SS}	Negative Supply Voltage
3	IN+	Non-Inverting Input
4	IN-	Inverting Input
5	NC	No Connect
6	V _{DD}	Positive Supply Voltage

Function Table

Inputs	Outputs
IN(-) > IN(+)	Output LOW
IN(+) > IN(-)	Output HIGH

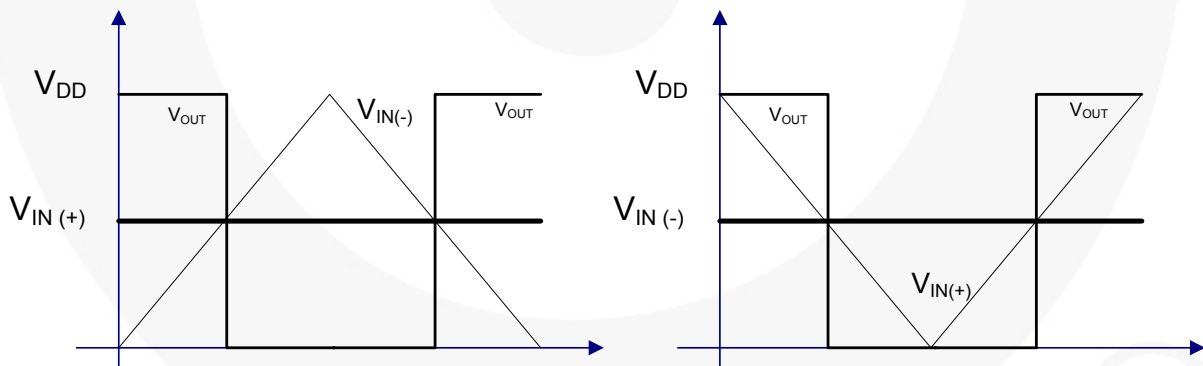

Figure 3. V_{IN} vs. V_{OUT}

Absolute Maximum Ratings

Stresses exceeding the absolute maximum ratings may damage the device. The device may not function or be operable above the recommended operating conditions and stressing the parts to these levels is not recommended. In addition, extended exposure to stresses above the recommended operating conditions may affect device reliability. The absolute maximum ratings are stress ratings only.

Symbol	Parameter	Condition	Min.	Max.	Unit
V_{DD} to V_{SS}	Supply Voltage		-3.0	+3.0	V
			0	6.0	
DV_{IN}	Differential Input Voltage			±6	
V_{IN}	Input Voltage			V_{SS} to V_{DD}	V
t_s	Output Short Circuit Duration ⁽¹⁾			Indefinite	s
T_J	Junction Temperature			+150	°C
T_{STG}	Storage Temperature Range		-65	+150	°C
P_D	Power Dissipation			194	mW
Θ_{JA}	Thermal Resistance			335	°C/W
ESD	IEC 61000-4-2 System ESD	Air Gap		15	kV
		Contact		8	
	JEDEC JESD22-A114, Human Body Model	All Pins		8	
		Pin to Pin: IN(-), IN(+) to V_{DD} or V_{SS}		12	
	JEDEC JESD22-C101, Charged Device Model	All Pins		2	

Note:

- The maximum total power dissipation must not be exceeded.

Recommended Operating Conditions

The Recommended Operating Conditions table defines the conditions for actual device operation. Recommended operating conditions are specified to ensure optimal performance to the datasheet specifications. Fairchild does not recommend exceeding them or designing to Absolute Maximum Ratings.

Symbol	Parameter	Condition	Min.	Max.	Unit
V_{DD} to V_{SS}	Power Supply		-2.75	+2.75	V
			0	5.50	
V_{DD}	Power Supply	V_{SS} 0 V	1.6	5.5	V
V_{IN}	Input Voltage			V_{SS} to V_{DD}	V
I_{OH}/I_{OL}	Output Sink/Source Current	V_{DD} 5.0 V		5	mA
		V_{DD} 3.0 V		3	
		V_{DD} 1.6 V		1	
T_A	Operating Temperature, Free Air		-40	+85	°C

Electrical Characteristics

Symbol	Parameter	Condition	Min.	Typ.	Max.	Unit
V_{DD}=5.5V, V_{SS}=GND, and T_A=+25°C						
V _{HYS}	Input Hysteresis	V _{CM} =0.5 V _{DD}		4		mV
V _{IO}	Input Offset Voltage ⁽²⁾	V _{CM} =0.5 V _{DD}	-15	±1	+15	mV
I _{IO}	Input Offset Current			10		pA
I _I	Input Bias Current			10		pA
V _{CM}	Common Mode Input Voltage		V _{SS}		V _{DD}	V
CMRR	Common Mode Rejection Ratio ⁽³⁾	V _{CM} =V _{DD}		68		dB
I _{DD}	Supply Current			6	17	μA
PSRR	Power Supply Rejection Ratio ⁽³⁾	ΔV _{DD} =0.5 V	45	80		dB
I _{OS}	Output Short Circuit Current	V _O =V _{DD}		60		mA
		V _O =V _{SS}		90		
V _{OL}	Low-Level Output Voltage	I _{SINK} =5.0 mA		0.1	0.3	V
V _{OH}	High-Level Output Voltage	I _{SOURCE} =5.0 mA	5.2	5.4		V
t _{PLH}	Propagation Delay (Turn-On)	Overdrive 20 mV, C _L =15 pF		0.40		μs
t _{PHL}	Propagation Delay (Turn-Off)	Overdrive=20 mV, C _L =15 pF		0.42		μs
t _{TLH}	Response Time, Output Rise/Fall ⁽⁴⁾	C _L =50 pF		4.0		ns
t _{THL}				5.4		
V_{DD}=3V, V_{SS}=GND, and T_A=+25°C						
V _{HYS}	Input Hysteresis	V _{CM} =0.5 V _{DD}		4		mV
V _{IO}	Input Offset Voltage ⁽²⁾	V _{CM} =0.5 V _{DD}	-15	±1	+15	mV
I _{IO}	Input Offset Current			10		pA
I _I	Input Bias Current			10		pA
V _{CM}	Common Mode Input Voltage		V _{SS}		V _{DD}	V
CMRR	Common Mode Rejection Ratio ⁽³⁾	V _{CM} =V _{DD}		60		dB
I _{DD}	Supply Current			5.5	15.0	μA
PSRR	Power Supply Rejection Ratio ⁽³⁾	ΔV _{DD} =0.5 V	45	80		dB
I _{OS}	Output Short Circuit Current	V _O =V _{DD}		27		mA
		V _O =V _{SS}		35		
V _{OL}	Low-Level Output Voltage	I _{SINK} =3.0 mA		0.15	0.35	V
V _{OH}	High-Level Output Voltage	I _{SOURCE} =3.0 mA	2.65	2.85		V
t _{PLH}	Propagation Delay (Turn-On)	Overdrive=20 mV, C _L =15 pF		0.45		μs
t _{PHL}	Propagation Delay (Turn-Off)	Overdrive=20 mV, C _L =15 pF		0.47		μs
t _{TLH}	Response Time, Output Rise/Fall ⁽⁴⁾	C _L =50pF		6.1		ns
t _{THL}				6.2		

Continued on the following page...

Electrical Characteristics (Continued)

Symbol	Parameter	Condition	Min.	Typ.	Max.	Unit
V_{DD} 1.6V, V_{SS} GND, and T_A=+25°C						
V _{HYS}	Input Hysteresis	V _{CM} =0.5 V _{DD}		3.5		mV
V _{IO}	Input Offset Voltage ⁽²⁾	V _{CM} =0.5 V _{DD}	-15	±1	+15	mV
I _{IO}	Input Offset Current			10		pA
I _I	Input Bias Current			10		pA
V _{CM}	Common Mode Input Voltage		V _{SS}		V _{DD}	V
CMRR	Common Mode Rejection Ratio ⁽³⁾	V _{CM} =V _{DD}		56		dB
I _{DD}	Supply Current			5	15	μA
PSRR	Power Supply Rejection Ratio ⁽³⁾	ΔV _{DD} =0.5 V	45	80		dB
I _{OS}	Output Short Circuit Current	V _O =V _{DD}		5.5		mA
		V _O =V _{SS}		7.5		
V _{OL}	Low-Level Output Voltage	I _{SINK} =1.0 mA		0.10	0.25	V
V _{OH}	High-Level Output Voltage	I _{SOURCE} =1.0 mA	1.35	1.50		V
t _{PLH}	Propagation Delay (Turn-On)	Overdrive=20 Mv, C _L =15pF		0.52		μs
t _{PHL}	Propagation Delay (Turn-Off)	Overdrive=20 Mv, C _L =15 pF		0.54		μs
t _{TLH}	Response Time, Output Rise/Fall ⁽⁴⁾	C _L =50 pF		16.5		ns
t _{THL}				13.0		

Notes:

- Differential input switching level is guaranteed at the minimum or maximum offset voltage, minus or plus half the maximum hysteresis voltage.
- Guaranteed by design and characterization data.
- Input signal: 1 kHz, square-wave signal with 10 ns edge rate.

Typical Performance Characteristics

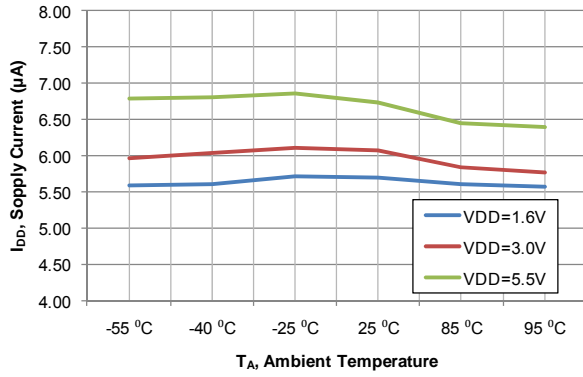

Figure 4. Supply Current vs. Temperature

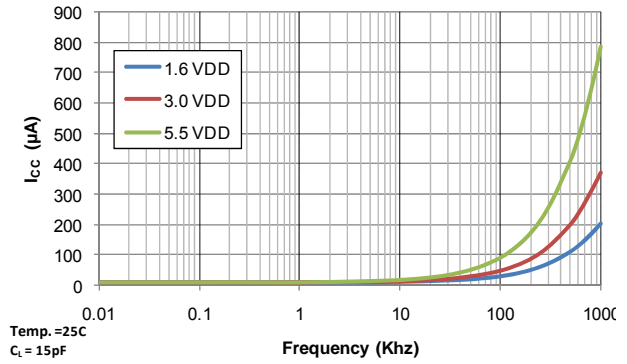

Figure 5. Supply Current vs. Output Transition Frequency

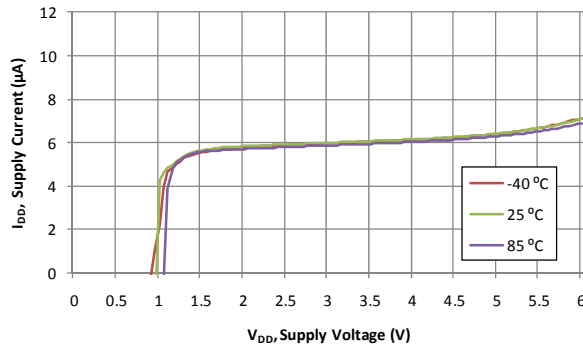

Figure 6. Supply Current vs. Supply Voltage

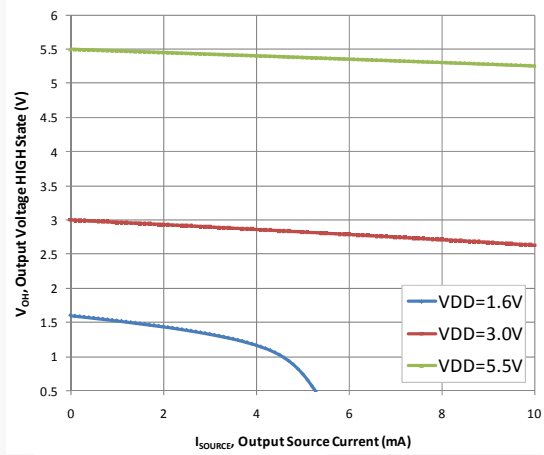

Figure 7. Output HIGH vs. Output Drive Current

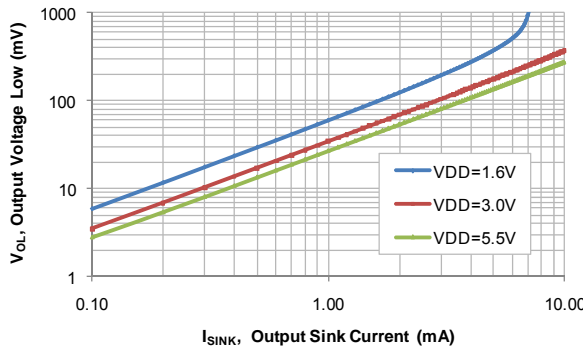

Figure 8. Output LOW vs. Output Drive Current

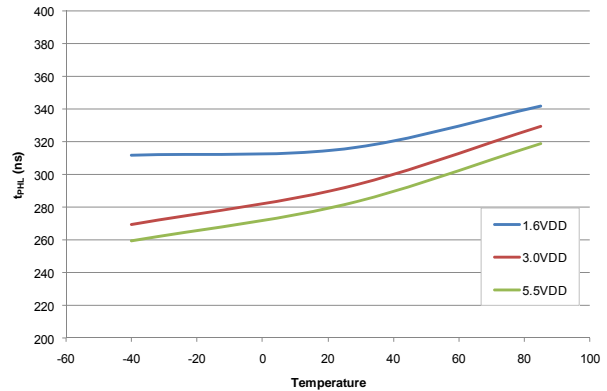

Figure 9. Propagation Delay (t_{PHL}) vs. Temperature

Typical Performance Characteristics (Continued)

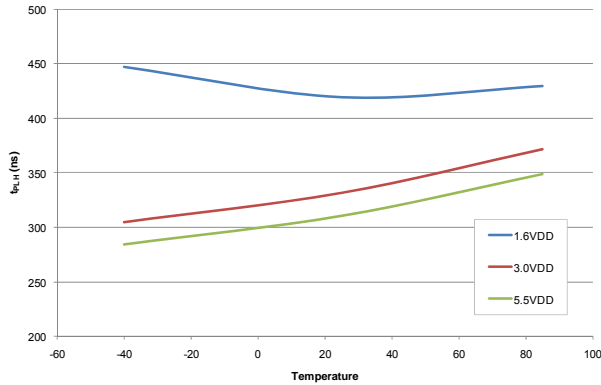

Figure 10. Propagation Delay (t_{PLH}) vs. Temperature

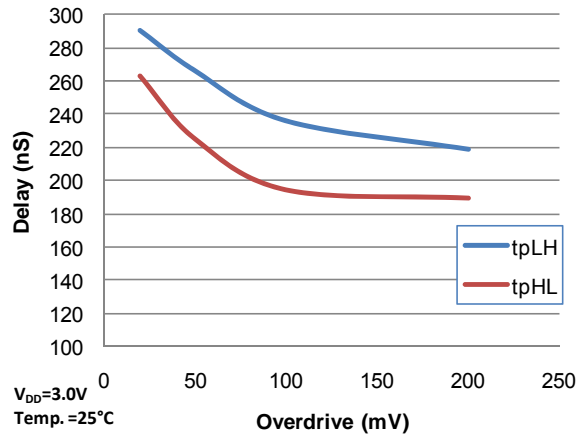

Figure 11. Propagation Delay vs. Input Overdrive

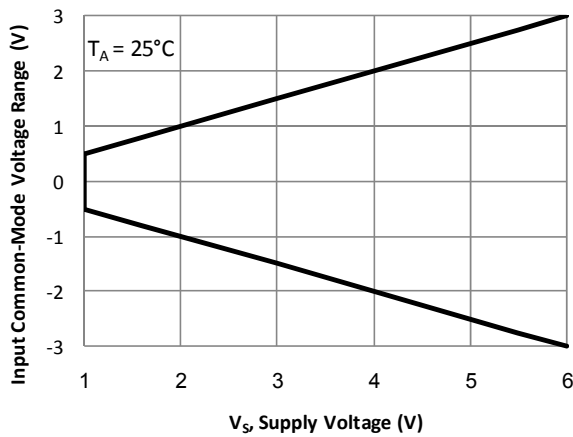

Figure 12. Input Common-Mode Voltage Range vs. Supply Voltage

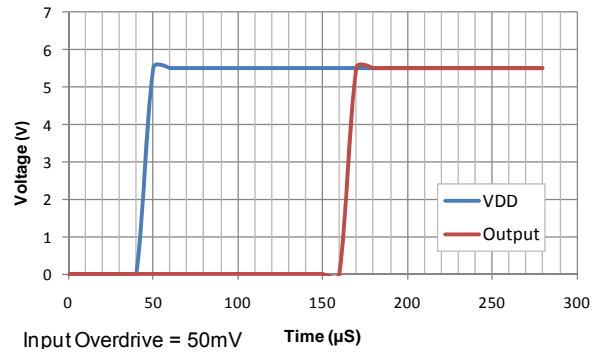
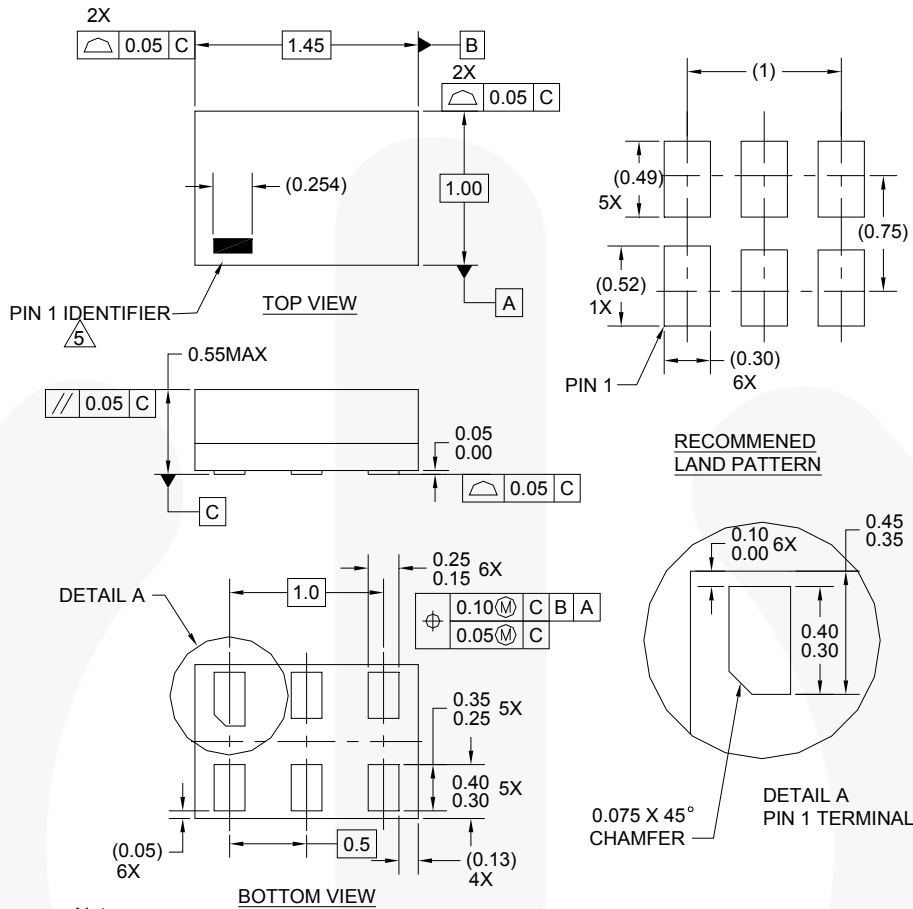

Figure 13. Power-Up Delay

Physical Dimensions



- Notes:
1. CONFORMS TO JEDEC STANDARD M0-252 VARIATION UAAD
 2. DIMENSIONS ARE IN MILLIMETERS
 3. DRAWING CONFORMS TO ASME Y14.5M-1994
 4. FILENAME AND REVISION: MAC06AREV4
- △. PIN ONE IDENTIFIER IS 2X LENGTH OF ANY OTHER LINE IN THE MARK CODE LAYOUT.

Figure 14. 6-Lead, MicroPak™, 1 x 1.45 mm Wide

Package drawings are provided as a service to customers considering Fairchild components. Drawings may change in any manner without notice. Please note the revision and/or date on the drawing and contact a Fairchild Semiconductor representative to verify or obtain the most recent revision. Package specifications do not expand the terms of Fairchild's worldwide terms and conditions, specifically the warranty therein, which covers Fairchild products.

Always visit Fairchild Semiconductor's online packaging area for the most recent package drawings:
<http://www.fairchildsemi.com/packaging/>.

Tape and Reel Specifications

Please visit Fairchild Semiconductor's online packaging area for the most recent tape and reel specifications:
http://www.fairchildsemi.com/products/logic/pdf/micropak_tr.pdf.

Package Designator	Tape Section	Cavity Number	Cavity Status	Cover Type Status
L6X	Leader (Start End)	125 (Typical)	Empty	Sealed
	Carrier	5000	Filled	Sealed
	Trailer (Hub End)	75 (Typical)	Empty	Sealed



TRADEMARKS

The following includes registered and unregistered trademarks and service marks, owned by Fairchild Semiconductor and/or its global subsidiaries, and is not intended to be an exhaustive list of all such trademarks.

2Cool™
AccuPower™
AX-CAP™*
BitSiC™
Build it Now™
CorePLUS™
CorePOWER™
CROSSVOLT™
CTL™
Current Transfer Logic™
DEUXPEED®
Dual Cool™
EcoSPARK®
EfficientMax™
ESBC™
F™
Fairchild®
Fairchild Semiconductor®
FACT Quiet Series™
FACT®
FAST®
FastvCore™
FETBench™
FPST™

F-PFS™
FRFET®
Global Power Resource™
GreenBridge™
Green FPST™
Green FPST™ e-Series™
Gmax™
GTO™
IntelliMAX™
ISOPLANAR™
Making Small Speakers Sound Louder and Better™
MegaBuck™
MICROCOUPLER™
MicroFET™
MicroPak™
MicroPak2™
MillerDrive™
MotionMax™
mWSaver™
OptoHiT™
OPTOLOGIC®
OPTOPLANAR®

PowerTrench®
PowerXS™
Programmable Active Droop™
QFET®
QS™
Quiet Series™
RapidConfigure™
™
Saving our world, 1mW/W at a time™
SignalWise™
SmartMax™
SMART START™
Solutions for Your Success™
SPM®
STEALTH™
SuperFET®
SuperSOT™-3
SuperSOT™-8
SuperSOT™-8
SupreMOS®
SyncFET™
Sync-Lock™
SYSTEM GENERAL®

The Power Franchise®
the power franchise
TinyBoost™
TinyBuck™
TinyCalc™
TinyLogic®
TINYOPTO™
TinyPower™
TinyPWM™
TinyWire™
TranSiC™
TriFault Detect™
TRUECURRENT®
µSerDes™

UHC®
Ultra FRFET™
UniFET™
VCX™
VisualMax™
VoltagePlus™
XS™

* Trademarks of System General Corporation, used under license by Fairchild Semiconductor.

DISCLAIMER

FAIRCHILD SEMICONDUCTOR RESERVES THE RIGHT TO MAKE CHANGES WITHOUT FURTHER NOTICE TO ANY PRODUCTS HEREIN TO IMPROVE RELIABILITY, FUNCTION, OR DESIGN. FAIRCHILD DOES NOT ASSUME ANY LIABILITY ARISING OUT OF THE APPLICATION OR USE OF ANY PRODUCT OR CIRCUIT DESCRIBED HEREIN; NEITHER DOES IT CONVEY ANY LICENSE UNDER ITS PATENT RIGHTS, NOR THE RIGHTS OF OTHERS. THESE SPECIFICATIONS DO NOT EXPAND THE TERMS OF FAIRCHILD'S WORLDWIDE TERMS AND CONDITIONS, SPECIFICALLY THE WARRANTY THEREIN, WHICH COVERS THESE PRODUCTS.

LIFE SUPPORT POLICY

FAIRCHILD'S PRODUCTS ARE NOT AUTHORIZED FOR USE AS CRITICAL COMPONENTS IN LIFE SUPPORT DEVICES OR SYSTEMS WITHOUT THE EXPRESS WRITTEN APPROVAL OF FAIRCHILD SEMICONDUCTOR CORPORATION.

As used herein:

1. Life support devices or systems are devices or systems which, (a) are intended for surgical implant into the body or (b) support or sustain life, and (c) whose failure to perform when properly used in accordance with instructions for use provided in the labeling, can be reasonably expected to result in a significant injury of the user.
2. A critical component in any component of a life support, device, or system whose failure to perform can be reasonably expected to cause the failure of the life support device or system, or to affect its safety or effectiveness.

ANTI-COUNTERFEITING POLICY

Fairchild Semiconductor Corporation's Anti-Counterfeiting Policy. Fairchild's Anti-Counterfeiting Policy is also stated on our external website, www.fairchildsemi.com, under Sales Support.

Counterfeiting of semiconductor parts is a growing problem in the industry. All manufacturers of semiconductor products are experiencing counterfeiting of their parts. Customers who inadvertently purchase counterfeit parts experience many problems such as loss of brand reputation, substandard performance, failed applications, and increased cost of production and manufacturing delays. Fairchild is taking strong measures to protect ourselves and our customers from the proliferation of counterfeit parts. Fairchild strongly encourages customers to purchase Fairchild parts either directly from Fairchild or from Authorized Fairchild Distributors who are listed by country on our web page cited above. Products customers buy either from Fairchild directly or from Authorized Fairchild Distributors are genuine parts, have full traceability, meet Fairchild's quality standards for handling and storage and provide access to Fairchild's full range of up-to-date technical and product information. Fairchild and our Authorized Distributors will stand behind all warranties and will appropriately address any warranty issues that may arise. Fairchild will not provide any warranty coverage or other assistance for parts bought from Unauthorized Sources. Fairchild is committed to combat this global problem and encourage our customers to do their part in stopping this practice by buying direct or from authorized distributors.

PRODUCT STATUS DEFINITIONS

Definition of Terms

Datasheet Identification	Product Status	Definition
Advance Information	Formative / In Design	Datasheet contains the design specifications for product development. Specifications may change in any manner without notice.
Preliminary	First Production	Datasheet contains preliminary data; supplementary data will be published at a later date. Fairchild Semiconductor reserves the right to make changes at any time without notice to improve design.
No Identification Needed	Full Production	Datasheet contains final specifications. Fairchild Semiconductor reserves the right to make changes at any time without notice to improve the design.
Obsolete	Not In Production	Datasheet contains specifications on a product that is discontinued by Fairchild Semiconductor. The datasheet is for reference information only.

Rev. 163

Mouser Electronics

Authorized Distributor

Click to View Pricing, Inventory, Delivery & Lifecycle Information:

[Fairchild Semiconductor:](#)

[FAN156L6X](#)