

# FDD5N50U

## N-Channel UniFET™ Ultra FRFET™ MOSFET

500 V, 3 A, 2.0 Ω

### Features

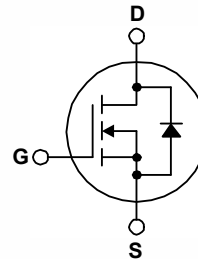
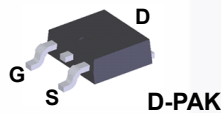
- $R_{DS(on)} = 1.65 \Omega$  (Typ.) @  $V_{GS} = 10 V, I_D = 1.5 A$
- Low Gate Charge (Typ. 11 nC)
- Low  $C_{rss}$  (Typ. 5 pF)
- 100% Avalanche Tested
- RoHS Compliant

### Applications

- LCD/LED/PDP TV
- Lighting
- Uninterruptible Power Supply

### Description

UniFET™ MOSFET is Fairchild Semiconductor's high voltage MOSFET family based on planar stripe and DMOS technology. This MOSFET is tailored to reduce on-state resistance, and to provide better switching performance and higher avalanche energy strength. UniFET Ultra FRFET™ MOSFET has much superior body diode reverse recovery performance. Its  $t_{rr}$  is less than 50nsec and the reverse  $dv/dt$  immunity is 20V/nsec while normal planar MOSFETs have over 200nsec and 4.5V/nsec respectively. Therefore UniFET Ultra FRFET MOSFET can remove additional component and improve system reliability in certain applications that require performance improvement of the MOSFET's body diode. This device family is suitable for switching power converter applications such as power factor correction (PFC), flat panel display (FPD) TV power, ATX and electronic lamp ballasts.



### MOSFET Maximum Ratings $T_C = 25^\circ C$ unless otherwise noted.

| Symbol         | Parameter  | FDD5N50UTM_WS                        | Unit       |
|----------------|--|--------------------------------------|------------|
| $V_{DSS}$      | Drain to Source Voltage  | 500                                  | V          |
| $V_{GSS}$      | Gate to Source Voltage   | ±30                                  | V          |
| $I_D$          | Drain Current  | - Continuous ( $T_C = 25^\circ C$ )  | 3          |
|                |  | - Continuous ( $T_C = 100^\circ C$ ) | 1.8        |
| $I_{DM}$       | Drain Current  | - Pulsed (Note 1)                    | 12         |
| $E_{AS}$       | Single Pulsed Avalanche Energy                                       | (Note 2)                             | 275        |
| $I_{AR}$       | Avalanche Current  | (Note 1)                             | 3          |
| $E_{AR}$       | Repetitive Avalanche Energy  | (Note 1)                             | 4          |
| $dv/dt$        | Peak Diode Recovery $dv/dt$  | (Note 3)                             | 4.5        |
| $P_D$          | Power Dissipation  | ( $T_C = 25^\circ C$ )               | 40         |
|                |  | - Derate Above $25^\circ C$          | 0.3        |
| $T_J, T_{STG}$ | Operating and Storage Temperature Range                              | -55 to +150                          | $^\circ C$ |
| $T_L$          | Maximum Lead Temperature for Soldering, 1/8" from Case for 5 Seconds | 300                                  | $^\circ C$ |

### Thermal Characteristics

| Symbol          | Parameter                                     | FDD5N50UTM_WS | Unit         |
|-----------------|---|---------------|--------------|
| $R_{\theta JC}$ | Thermal Resistance, Junction to Case, Max.    | 1.4           | $^\circ C/W$ |
| $R_{\theta JA}$ | Thermal Resistance, Junction to Ambient, Max. | 110           |              |

## Package Marking and Ordering Information

| Part Number   | Top Mark | Package | Packing Method | Reel Size | Tape Width | Quantity   |
|---------------|----------|---------|----------------|-----------|------------|------------|
| FDD5N50UTM_WS | FDD5N50U | DPAK    | Tape and Reel  | 330 mm    | 16 mm      | 2500 units |

## Electrical Characteristics $T_C = 25^\circ\text{C}$ unless otherwise noted.

| Symbol | Parameter | Test Conditions | Min. | Typ. | Max. | Unit |
|--------|-----------|-----------------|------|------|------|------|
|--------|-----------|-----------------|------|------|------|------|

### Off Characteristics

|                                |   |  |     |     |           |                           |
|--------------------------------|---|--|-----|-----|-----------|---------------------------|
| $BV_{DSS}$                     | Drain to Source Breakdown Voltage         | $I_D = 250 \mu\text{A}, V_{GS} = 0 \text{V}, T_J = 25^\circ\text{C}$                             | 500 | -   | -         | V                         |
| $\Delta BV_{DSS} / \Delta T_J$ | Breakdown Voltage Temperature Coefficient | $I_D = 250 \mu\text{A}$ , Referenced to $25^\circ\text{C}$                                       | -   | 0.6 | -         | $\text{V}/^\circ\text{C}$ |
| $I_{DSS}$                      | Zero Gate Voltage Drain Current           | $V_{DS} = 500 \text{V}, V_{GS} = 0 \text{V}$<br>$V_{DS} = 400 \text{V}, T_C = 125^\circ\text{C}$ | -   | -   | 25<br>250 | $\mu\text{A}$             |
| $I_{GSS}$                      | Gate to Body Leakage Current              | $V_{GS} = \pm 30 \text{V}, V_{DS} = 0 \text{V}$  | -   | -   | $\pm 100$ | nA                        |

### On Characteristics

|              |                                      |  |   |      |     |          |
|--------------|--------------------------------------|--|---|------|-----|----------|
| $V_{GS(th)}$ | Gate Threshold Voltage               | $V_{GS} = V_{DS}, I_D = 250 \mu\text{A}$   | 3 | -    | 5   | V        |
| $R_{DS(on)}$ | Static Drain to Source On Resistance | $V_{GS} = 10 \text{V}, I_D = 1.5 \text{A}$ | - | 1.65 | 2.0 | $\Omega$ |
| $g_{FS}$     | Forward Transconductance             | $V_{DS} = 20 \text{V}, I_D = 1.5 \text{A}$ | - | 4    | -   | S        |

### Dynamic Characteristics

|              |                               |  |          |     |     |    |
|--------------|-------------------------------|--|----------|-----|-----|----|
| $C_{iss}$    | Input Capacitance             | $V_{DS} = 25 \text{V}, V_{GS} = 0 \text{V},$<br>$f = 1 \text{MHz}$   | -        | 485 | 650 | pF |
| $C_{oss}$    | Output Capacitance            |  | -        | 65  | 90  | pF |
| $C_{rss}$    | Reverse Transfer Capacitance  |  | -        | 5   | 8   | pF |
| $Q_{g(tot)}$ | Total Gate Charge at 10V      | $V_{DS} = 400 \text{V}, I_D = 5 \text{A},$<br>$V_{GS} = 10 \text{V}$ | -        | 11  | 15  | nC |
| $Q_{gs}$     | Gate to Source Gate Charge    |  | -        | 3   | -   | nC |
| $Q_{gd}$     | Gate to Drain "Miller" Charge |  | (Note 4) | -   | 5   | -  |

### Switching Characteristics

|              |                     |   |          |    |    |    |
|--------------|---------------------|---|----------|----|----|----|
| $t_{d(on)}$  | Turn-On Delay Time  | $V_{DD} = 250 \text{V}, I_D = 5 \text{A},$<br>$V_{GS} = 10 \text{V}, R_G = 25 \Omega$ | -        | 14 | 38 | ns |
| $t_r$        | Turn-On Rise Time   |   | -        | 21 | 52 | ns |
| $t_{d(off)}$ | Turn-Off Delay Time |   | -        | 27 | 64 | ns |
| $t_f$        | Turn-Off Fall Time  |   | (Note 4) | -  | 20 | 50 |

### Drain-Source Diode Characteristics

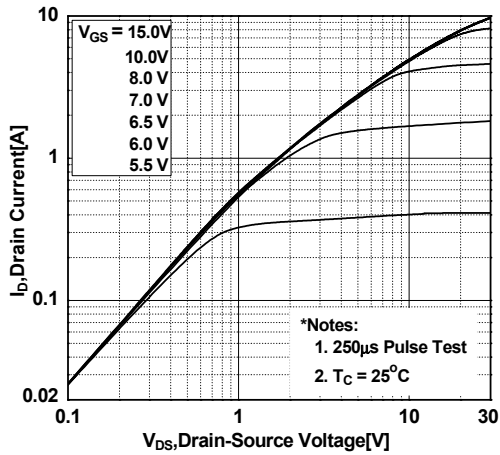
|          |  |   |   |    |     |    |
|----------|--|---|---|----|-----|----|
| $I_S$    | Maximum Continuous Drain to Source Diode Forward Current | -   | - | 3  | A   |    |
| $I_{SM}$ | Maximum Pulsed Drain to Source Diode Forward Current     | -   | - | 12 | A   |    |
| $V_{SD}$ | Drain to Source Diode Forward Voltage                    | $V_{GS} = 0 \text{V}, I_{SD} = 3 \text{A}$  | - | -  | 1.6 | V  |
| $t_{rr}$ | Reverse Recovery Time                                    | $V_{GS} = 0 \text{V}, I_{SD} = 5 \text{A},$<br>$di_F/dt = 100 \text{A}/\mu\text{s}$ | - | 36 | -   | ns |
| $Q_{rr}$ | Reverse Recovery Charge                                  |   | - | 33 | -   | nC |

#### Notes:

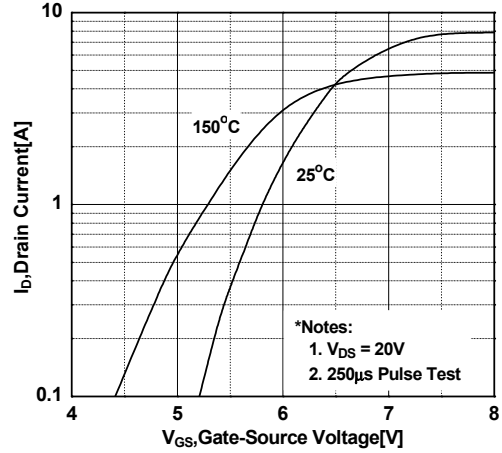
- 1: Repetitive rating: pulse width limited by maximum junction temperature.
- 2:  $L = 61 \text{mH}, I_{AS} = 3 \text{A}, V_{DD} = 50 \text{V}, R_G = 25 \Omega$ , starting  $T_J = 25^\circ\text{C}$ .
- 3:  $I_{SD} \leq 3 \text{A}, di/dt \leq 200 \text{A}/\mu\text{s}, V_{DD} \leq BV_{DSS}$ , starting  $T_J = 25^\circ\text{C}$ .
- 4: Essentially independent of operating temperature typical characteristics.

## Typical Performance Characteristics

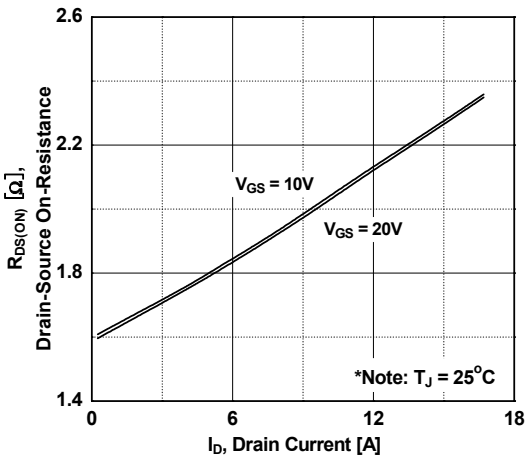
**Figure 1. On-Region Characteristics**



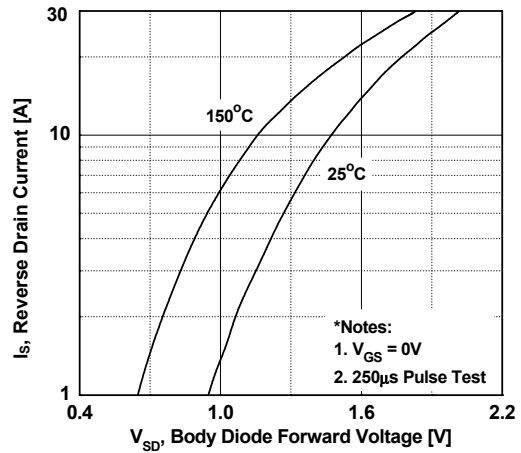
**Figure 2. Transfer Characteristics**



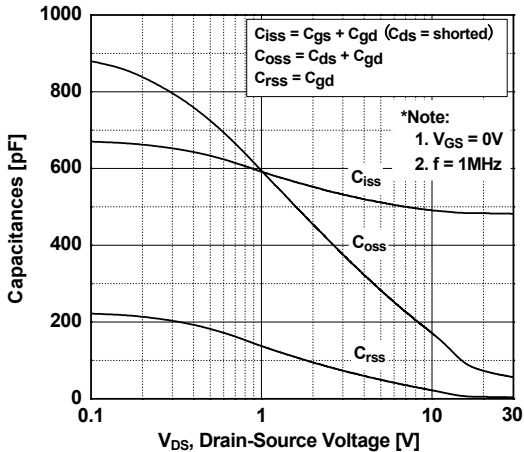
**Figure 3. On-Resistance Variation vs. Drain Current and Gate Voltage**



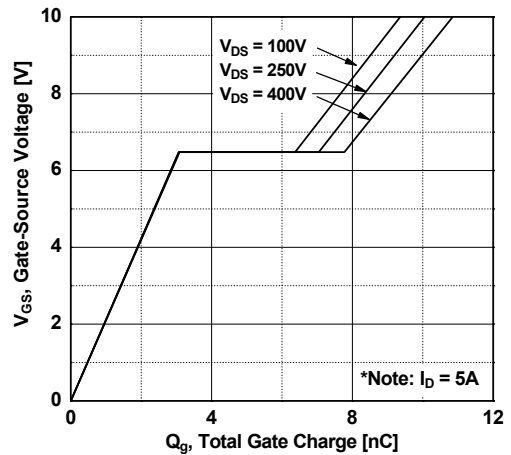
**Figure 4. Body Diode Forward Voltage Variation vs. Source Current and Temperature**



**Figure 5. Capacitance Characteristics**

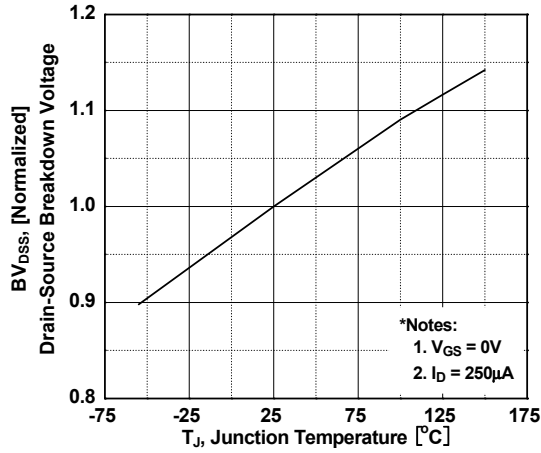


**Figure 6. Gate Charge Characteristics**

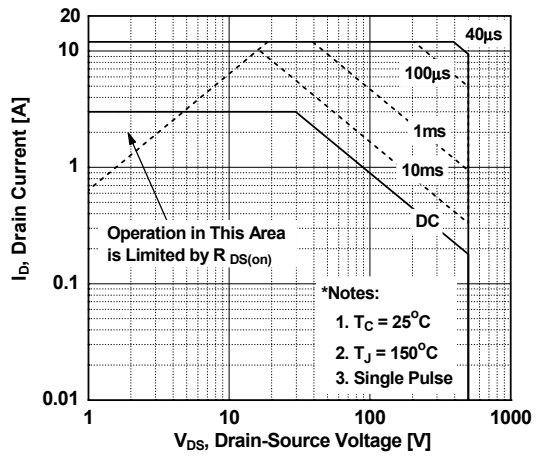


**Typical Performance Characteristics** (Continued)

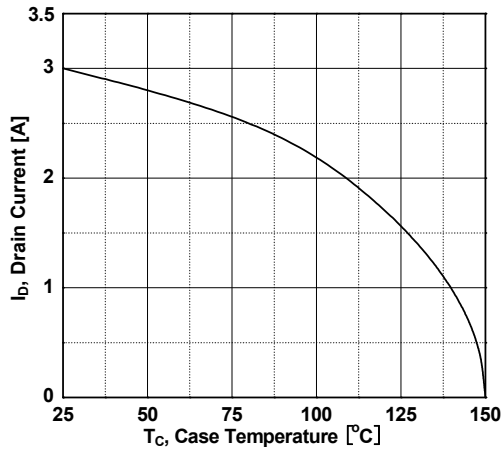
**Figure 7. Breakdown Voltage Variation vs. Temperature**



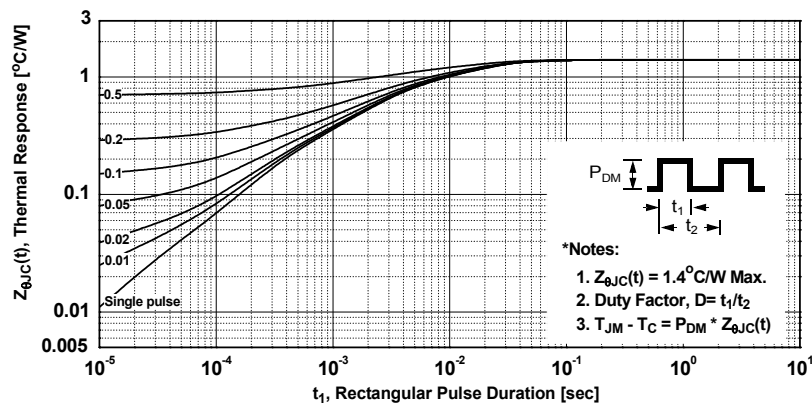
**Figure 8. Maximum Safe Operating Area**



**Figure 9. Maximum Drain Current vs. Case Temperature**



**Figure 10. Transient Thermal Response Curve**



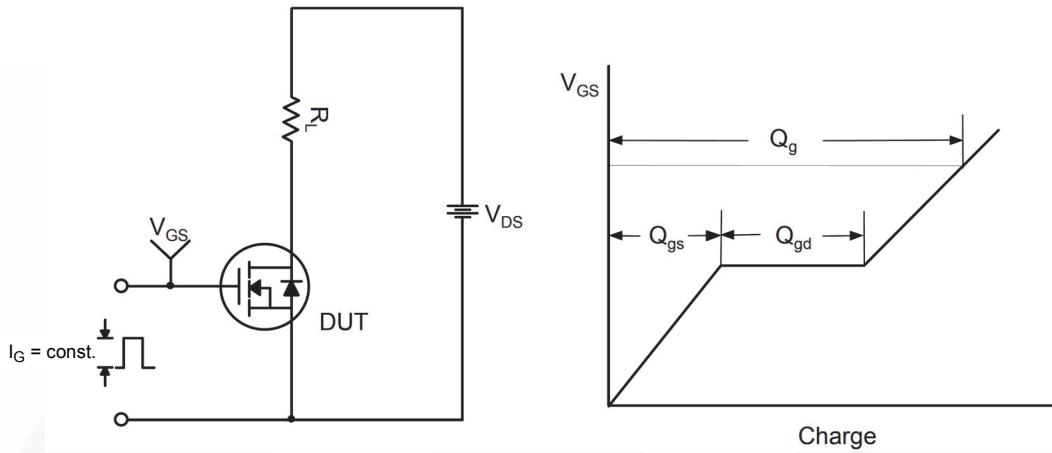


Figure 11. Gate Charge Test Circuit & Waveform



Figure 12. Resistive Switching Test Circuit & Waveforms

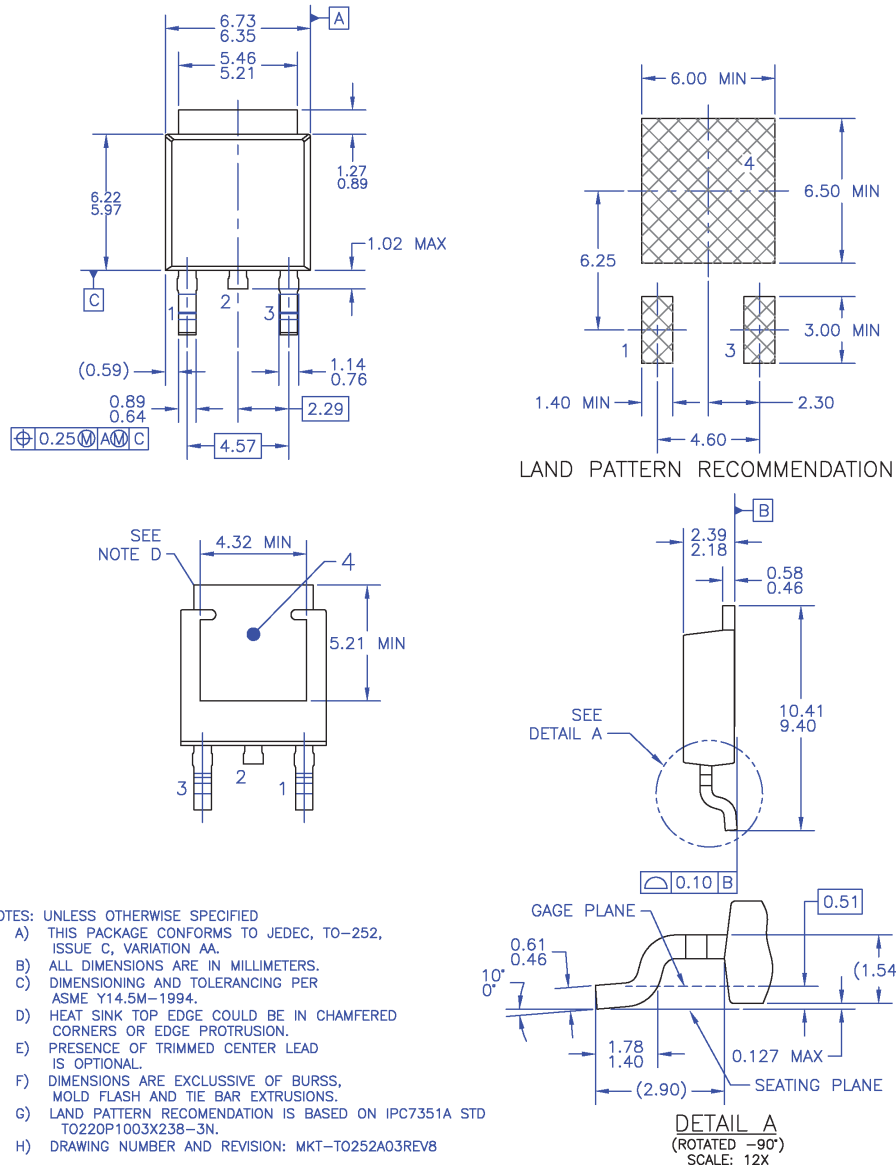


Figure 13. Unclamped Inductive Switching Test Circuit & Waveforms



Figure 14. Peak Diode Recovery  $dv/dt$  Test Circuit & Waveforms

## Mechanical Dimensions



**Figure 15. TO252 (D-PAK), Molded, 3-Lead, Option AA&AB**

Package drawings are provided as a service to customers considering Fairchild components. Drawings may change in any manner without notice. Please note the revision and/or date on the drawing and contact a Fairchild Semiconductor representative to verify or obtain the most recent revision. Package specifications do not expand the terms of Fairchild's worldwide terms and conditions, specifically the warranty therein, which covers Fairchild products.

Always visit Fairchild Semiconductor's online packaging area for the most recent package drawings:

[http://www.fairchildsemi.com/package/packageDetails.html?id=PN\\_TT252-003](http://www.fairchildsemi.com/package/packageDetails.html?id=PN_TT252-003)



**TRADEMARKS**

The following includes registered and unregistered trademarks and service marks, owned by Fairchild Semiconductor and/or its global subsidiaries, and is not intended to be an exhaustive list of all such trademarks.

- |                          |                         |   |                  |
|--------------------------|-------------------------|---|------------------|
| AccuPower™               | F-PFS™                  | PowerTrench®                                    | Sync-Lock™       |
| AX-CAP®*                 | FRFET®                  | PowerXS™  | SYSTEM GENERAL®* |
| BitSiC™                  | Global Power ResourceSM | Programmable Active Droop™                      | TinyBoost®       |
| Build it Now™            | GreenBridge™            | QFET®   | TinyBuck®        |
| CorePLUS™                | Green FPS™              | QS™   | TinyCalc™        |
| CorePOWER™               | Green FPS™ e-Series™    | Quiet Series™                                   | TinyLogic®       |
| CROSSVOLT™               | Gmax™                   | RapidConfigure™                                 | TINYOPTO™        |
| CTL™                     | GTO™                    | ISOPLANAR™                                      | TinyPower™       |
| Current Transfer Logic™  | IntelliMAX™             | Marking Small Speakers Sound Louder and Better™ | TinyPWM™         |
| DEUXPEED®                | ISOPLANAR™              | MegaBuck™                                       | TinyWire™        |
| Dual Cool™               | MicroFET™               | MICROCOUPLER™                                   | TranSiC™         |
| EcoSPARK®                | MicroPak™               | MicroPak2™                                      | TriFault Detect™ |
| EfficientMax™            | MillerDrive™            | MotionMax™                                      | TRUECURRENT®*    |
| ESBC™                    | FAST Quiet Series™      | mWSaver®  | µSerDes™         |
| <b>F</b> ®               | FACT®                   | OptoHiT™  | <b>µ</b> SerDes™ |
| Fairchild®               | FAST®                   | OPTOLOGIC®                                      | UHC®             |
| Fairchild Semiconductor® | FastvCore™              | OPTOPLANAR®                                     | Ultra FRFET™     |
| FACT Quiet Series™       | FETBench™               | SPM®  | UniFET™          |
| FACT®                    | FPS™                    | STEALTH™  | VCX™             |
| FAST®                    |                         | SuperFET®                                       | VisualMax™       |
| FastvCore™               |                         | SuperSOT™-3                                     | VoltagePlus™     |
| FETBench™                |                         | SuperSOT™-6                                     | XS™              |
| FPS™                     |                         | SuperSOT™-8                                     |                  |
|                          |                         | SupreMOS®                                       |                  |
|                          |                         | SyncFET™  |                  |

\*Trademarks of System General Corporation, used under license by Fairchild Semiconductor.

**DISCLAIMER**

FAIRCHILD SEMICONDUCTOR RESERVES THE RIGHT TO MAKE CHANGES WITHOUT FURTHER NOTICE TO ANY PRODUCTS HEREIN TO IMPROVE RELIABILITY, FUNCTION, OR DESIGN. FAIRCHILD DOES NOT ASSUME ANY LIABILITY ARISING OUT OF THE APPLICATION OR USE OF ANY PRODUCT OR CIRCUIT DESCRIBED HEREIN; NEITHER DOES IT CONVEY ANY LICENSE UNDER ITS PATENT RIGHTS, NOR THE RIGHTS OF OTHERS. THESE SPECIFICATIONS DO NOT EXPAND THE TERMS OF FAIRCHILD'S WORLDWIDE TERMS AND CONDITIONS, SPECIFICALLY THE WARRANTY THEREIN, WHICH COVERS THESE PRODUCTS.

**LIFE SUPPORT POLICY**

FAIRCHILD'S PRODUCTS ARE NOT AUTHORIZED FOR USE AS CRITICAL COMPONENTS IN LIFE SUPPORT DEVICES OR SYSTEMS WITHOUT THE EXPRESS WRITTEN APPROVAL OF FAIRCHILD SEMICONDUCTOR CORPORATION.

As used here in:

- Life support devices or systems are devices or systems which, (a) are intended for surgical implant into the body or (b) support or sustain life, and (c) whose failure to perform when properly used in accordance with instructions for use provided in the labeling, can be reasonably expected to result in a significant injury of the user.
- A critical component in any component of a life support, device, or system whose failure to perform can be reasonably expected to cause the failure of the life support device or system, or to affect its safety or effectiveness.

**ANTI-COUNTERFEITING POLICY**

Fairchild Semiconductor Corporation's Anti-Counterfeiting Policy. Fairchild's Anti-Counterfeiting Policy is also stated on our external website, www.Fairchildsemi.com, under Sales Support. Counterfeiting of semiconductor parts is a growing problem in the industry. All manufactures of semiconductor products are experiencing counterfeiting of their parts. Customers who inadvertently purchase counterfeit parts experience many problems such as loss of brand reputation, substandard performance, failed application, and increased cost of production and manufacturing delays. Fairchild is taking strong measures to protect ourselves and our customers from the proliferation of counterfeit parts. Fairchild strongly encourages customers to purchase Fairchild parts either directly from Fairchild or from Authorized Fairchild Distributors who are listed by country on our web page cited above. Products customers buy either from Fairchild directly or from Authorized Fairchild Distributors are genuine parts, have full traceability, meet Fairchild's quality standards for handling and storage and provide access to Fairchild's full range of up-to-date technical and product information. Fairchild and our Authorized Distributors will stand behind all warranties and will appropriately address and warranty issues that may arise. Fairchild will not provide any warranty coverage or other assistance for parts bought from Unauthorized Sources. Fairchild is committed to combat this global problem and encourage our customers to do their part in stopping this practice by buying direct or from authorized distributors.

**PRODUCT STATUS DEFINITIONS**

**Definition of Terms**

| Datasheet Identification | Product Status        | Definition  |
|--------------------------|-----------------------|---|
| Advance Information      | Formative / In Design | Datasheet contains the design specifications for product development. Specifications may change in any manner without notice.   |
| Preliminary              | First Production      | Datasheet contains preliminary data; supplementary data will be published at a later date. Fairchild Semiconductor reserves the right to make changes at any time without notice to improve design. |
| No Identification Needed | Full Production       | Datasheet contains final specifications. Fairchild Semiconductor reserves the right to make changes at any time without notice to improve the design.   |
| Obsolete                 | Not In Production     | Datasheet contains specifications on a product that is discontinued by Fairchild Semiconductor. The datasheet is for reference information only.  |

Rev. I66



# Mouser Electronics

Authorized Distributor

Click to View Pricing, Inventory, Delivery & Lifecycle Information:

[Fairchild Semiconductor:](#)

[FDD5N50UTM\\_WS](#)