

# FDP5800

## N-Channel Logic Level PowerTrench® MOSFET

60 V, 80 A, 6 mΩ

### Features

- $R_{DS(on)} = 4.6 \text{ m}\Omega$  (Typ.) @  $V_{GS} = 10 \text{ V}$ ,  $I_D = 80 \text{ A}$
- High Performance Trench Technology for Externly Low  $R_{DS(on)}$
- Low Gate Charge
- High Power and Current Handling Capability
- RoHS Compliant

### Description

This N-Channel MOSFET is produced using Fairchild Semiconductor's advanced PowerTrench® process that has been tailored to minimize the on-state resistance while maintaining superior switching performance.

### Applications

- Power Tools
- Motor Drives and Uninterruptible Power Supplies
- Synchronous Rectification
- Battery Protection Circuit

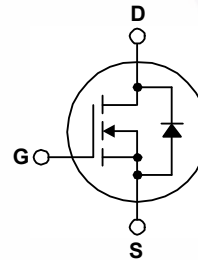
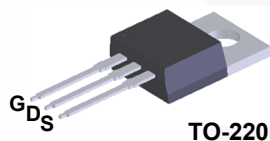

### MOSFET Maximum Ratings $T_C = 25^\circ\text{C}$ unless otherwise noted.

Symbol	Parameter	FDP5800	Unit
$V_{DSS}$	Drain-Source Voltage	60	V
$V_{GSS}$	Gate-Source Voltage	$\pm 20$	V
$I_D$	Drain Current	- Continuous ( $T_C = 25^\circ\text{C}$ )	80
		- Continuous ( $T_C = 100^\circ\text{C}$ )	80*
		- Continuous ( $T_A = 25^\circ\text{C}$ )	14
$I_{DM}$	Drain Current - Pulsed	320	A
$E_{AS}$	Single Pulsed Avalanche Energy (Note 1)	652	mJ
$P_D$	Power Dissipation ( $T_C = 25^\circ\text{C}$ ) - Derate Above $25^\circ\text{C}$	242	W
		1.61	W/ $^\circ\text{C}$
$T_J, T_{STG}$	Operating and Storage Temperature Range	-55 to +175	$^\circ\text{C}$

\*Drain current limited by package.

### Thermal Characteristics

Symbol	Parameter	FDP5800	Unit
$R_{\theta JC}$	Thermal Resistance, Junction to Case, Max.	0.62	$^\circ\text{C}/\text{W}$
$R_{\theta JA}$	Thermal Resistance, Junction to Ambient, Max.	62.5	

## Package Marking and Ordering Information

Part Number	Top Mark	Package	Packing Method	Reel Size	Tape Width	Quantity
FDP5800	FDP5800	TO-220	Tube	N/A	N/A	50 units

## Electrical Characteristics $T_C = 25^\circ\text{C}$ unless otherwise noted.

Symbol	Parameter	Conditions	Min.	Typ.	Max.	Unit
--------	-----------	------------	------	------	------	------

### Off Characteristics

$B_{VDSS}$	Drain-Source Breakdown Voltage	$I_D = 250 \mu\text{A}, V_{GS} = 0 \text{ V}, T_J = 25^\circ\text{C}$	60	--	--	V
$I_{DSS}$	Zero Gate Voltage Drain Current	$V_{DS} = 48 \text{ V}$ $V_{GS} = 0 \text{ V}$ $T_J = 150^\circ\text{C}$	--	--	1	$\mu\text{A}$
$I_{GSS}$	Gate-Body Leakage Current, Forward	$V_{GS} = \pm 20 \text{ V}, V_{DS} = 0 \text{ V}$	--	--	$\pm 100$	nA

### On Characteristics

$V_{GS(th)}$	Gate Threshold Voltage	$V_{GS} = V_{DS}, I_D = 250 \mu\text{A}$	1.0	--	2.5	V
$R_{DS(on)}$	Static Drain-Source On Resistance	$V_{GS} = 10 \text{ V}, I_D = 80 \text{ A}$	--	4.6	6.0	m $\Omega$
		$V_{GS} = 4.5 \text{ V}, I_D = 80 \text{ A}$	--	5.9	7.2	m $\Omega$
		$V_{GS} = 5 \text{ V}, I_D = 80 \text{ A}$	--	5.6	7.0	m $\Omega$
		$V_{GS} = 10 \text{ V}, I_D = 80 \text{ A},$ $T_J = 175^\circ\text{C}$	--	10.4	12.6	m $\Omega$

### Dynamic Characteristics

$C_{iss}$	Input Capacitance	$V_{DS} = 15 \text{ V}, V_{GS} = 0 \text{ V},$ $f = 1 \text{ MHz}$	--	6890	9160	pF
$C_{oss}$	Output Capacitance		--	750	1000	pF
$C_{rss}$	Reverse Transfer Capacitance		--	295	445	pF
$R_G$	Gate Resistance	$V_{GS} = 0.5 \text{ V}, f = 1 \text{ MHz}$	--	1.2	--	$\Omega$
$Q_g(TOT)$	Total Gate Charge at 10V	$V_{GS} = 0 \text{ V to } 10 \text{ V}$	--	112	145	nC
$Q_g(TH)$	Total Gate Charge at 5V	$V_{GS} = 0 \text{ V to } 5 \text{ V}$	--	58	--	nC
$Q_g(TH)$	Threshold Gate Charge	$V_{GS} = 0 \text{ V to } 1 \text{ V}$	--	7.0	--	nC
$Q_{gs}$	Gate to Source Gate Charge	$V_{DS} = 30 \text{ V},$ $I_D = 80 \text{ A},$ $I_g = 1 \text{ mA}$	--	23	--	nC
$Q_{gs2}$	Gate Charge Threshold to Plateau		--	13	--	nC
$Q_{gd}$	Gate to Drain "Miller" Charge		--	18	--	nC

### Switching Characteristics ( $V_{GS} = 10\text{V}$ )

$t_{ON}$	Turn-On Time	$V_{DD} = 30 \text{ V}, I_D = 80 \text{ A},$ $V_{GS} = 10 \text{ V}, R_G = 1.5 \Omega$	--	37	85	ns
$t_{d(on)}$	Turn-On Delay Time		--	18	46	ns
$t_r$	Turn-On Rise Time		--	19	47	ns
$t_{d(off)}$	Turn-Off Delay Time		--	55	120	ns
$t_f$	Turn-Off Fall Time		--	9	28	ns
$t_{OFF}$	Turn-Off Time		--	64	138	ns

### Drain-Source Diode Characteristics

$V_{SD}$	Drain-Source Diode Forward Voltage	$V_{GS} = 0 \text{ V}, I_{SD} = 80 \text{ A}$	--	--	1.25	V
		$V_{GS} = 0 \text{ V}, I_{SD} = 40 \text{ A}$	--	--	1.0	V
$t_{rr}$	Reverse Recovery Time	$V_{GS} = 0 \text{ V}, I_{SD} = 60 \text{ A},$	--	58	--	ns
$Q_{rr}$	Reverse Recovery Charge	$di_f/dt = 100 \text{ A}/\mu\text{s}$	--	106	--	nC

#### Notes:

1:  $L = 1 \text{ mH}, I_{AS} = 36 \text{ A}, V_{DD} = 54 \text{ V}, V_{GS} = 10 \text{ V}, R_G = 25 \Omega$ , Starting  $T_J = 25^\circ\text{C}$

## Typical Performance Characteristics

**Figure 1. On-Region Characteristics**

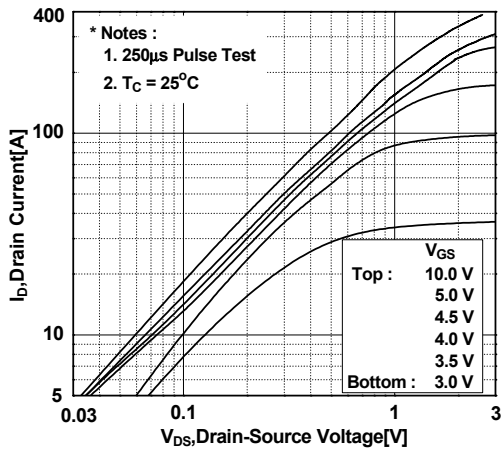

**Figure 3. On-Resistance Variation vs. Drain Current and Gate Voltage**

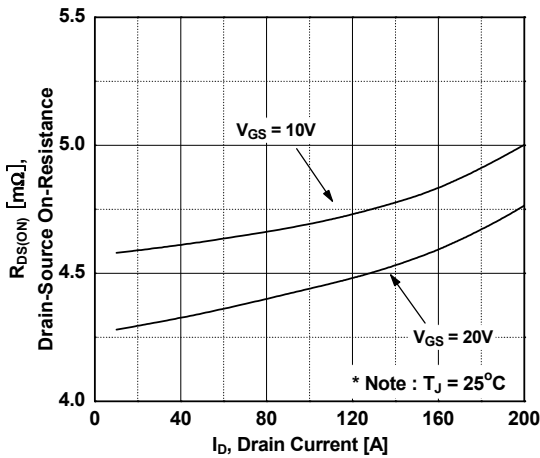

**Figure 5. Capacitance Characteristics**

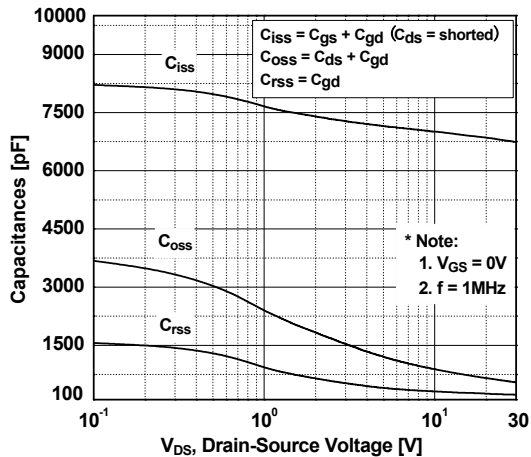

**Figure 2. Transfer Characteristics**

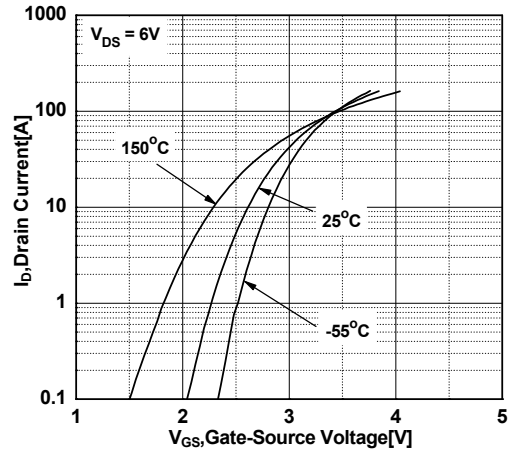

**Figure 4. Body Diode Forward Voltage Variation vs. Source Current and Temperature**

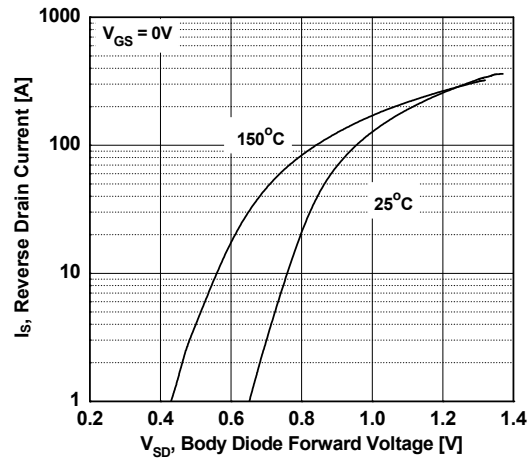

**Figure 6. Gate Charge Characteristics**

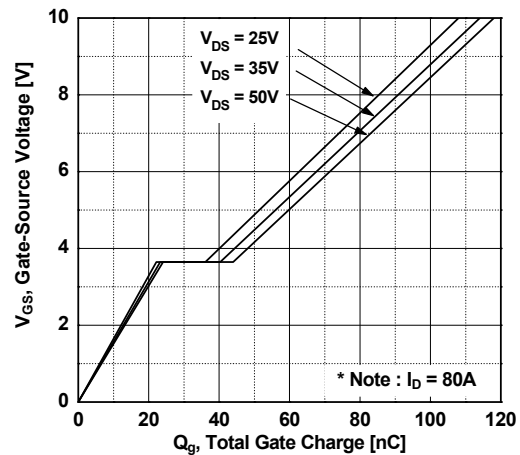

Typical Performance Characteristics (Continued)

Figure 7. Breakdown Voltage Variation vs. Temperature

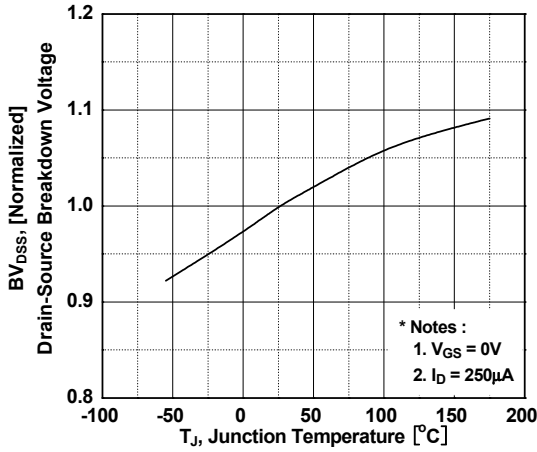

Figure 8. On-Resistance Variation vs. Temperature

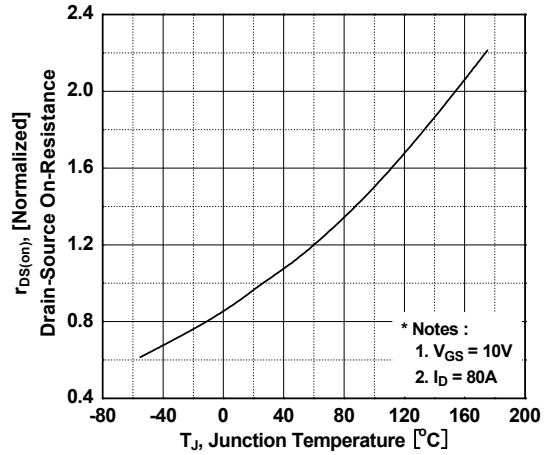

Figure 9. Maximum Safe Operating Area

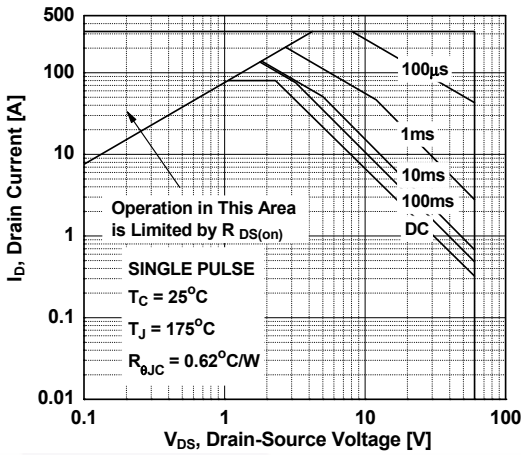

Figure 10. Maximum Drain Current vs. Case Temperature

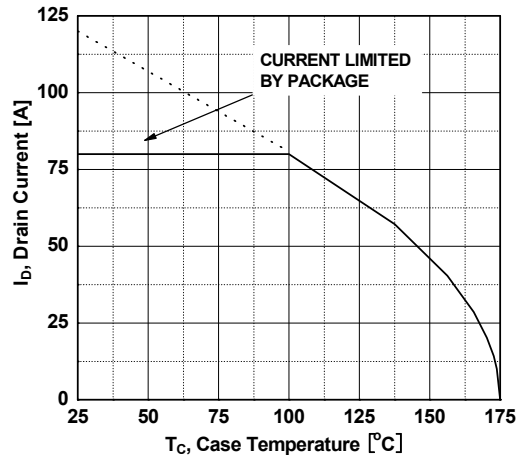
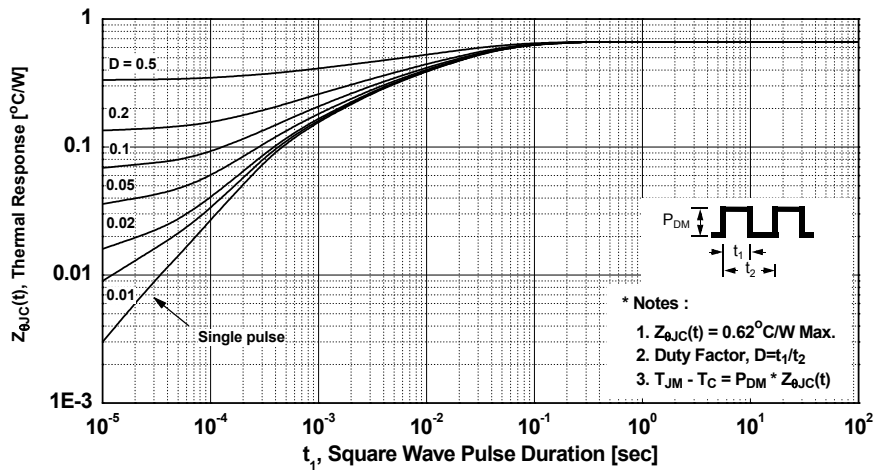

Figure 11. Transient Thermal Response Curve



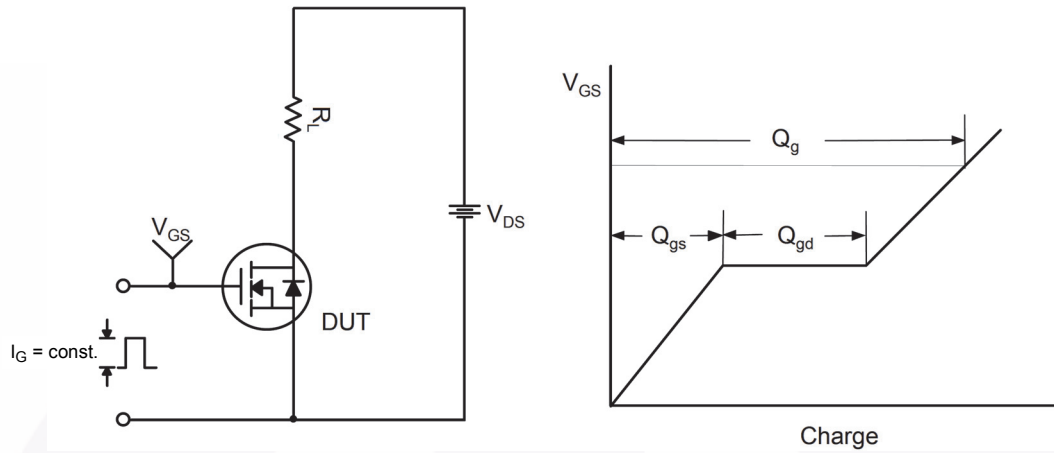

Figure 12. Gate Charge Test Circuit & Waveform



Figure 13. Resistive Switching Test Circuit & Waveforms

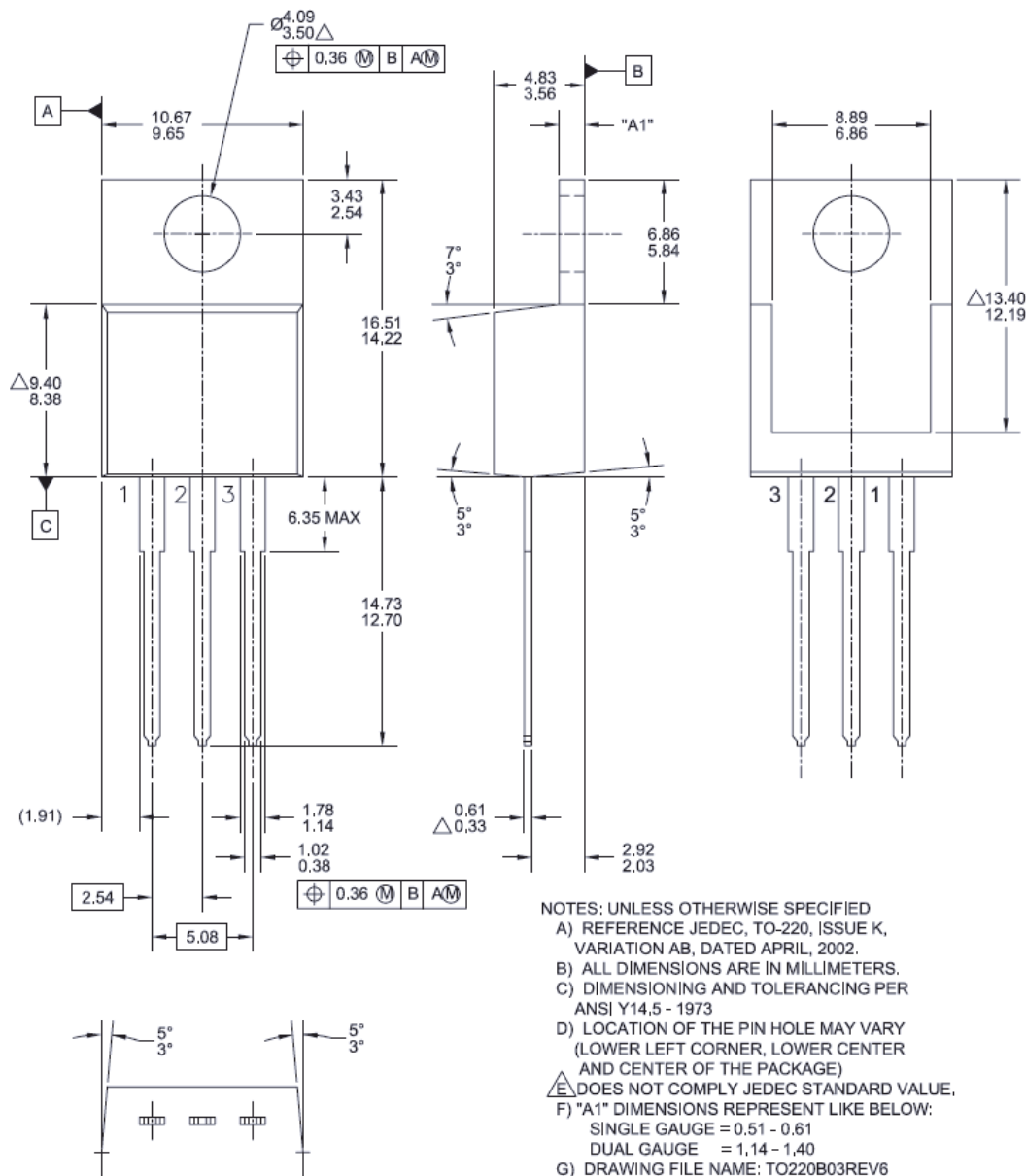

Figure 14. Unclamped Inductive Switching Test Circuit & Waveforms



Figure 15. Peak Diode Recovery  $dv/dt$  Test Circuit & Waveforms

## Mechanical Dimensions



**Figure 16. TO-220, Molded, 3-Lead, Jedec Variation AB**

Package drawings are provided as a service to customers considering Fairchild components. Drawings may change in any manner without notice. Please note the revision and/or date on the drawing and contact a Fairchild Semiconductor representative to verify or obtain the most recent revision. Package specifications do not expand the terms of Fairchild's worldwide terms and conditions, specifically the warranty therein, which covers Fairchild products.

Always visit Fairchild Semiconductor's online packaging area for the most recent package drawings:

[http://www.fairchildsemi.com/package/packageDetails.html?id=PN\\_TT220-003](http://www.fairchildsemi.com/package/packageDetails.html?id=PN_TT220-003)





# Mouser Electronics

Authorized Distributor

Click to View Pricing, Inventory, Delivery & Lifecycle Information:

[Fairchild Semiconductor:](#)

[FDP5800](#)