

# FDPF14N30

## N-Channel UniFET™ MOSFET

300 V, 14 A, 290 mΩ

### Features

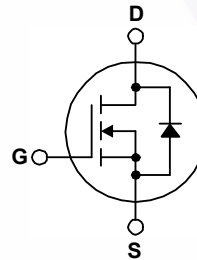
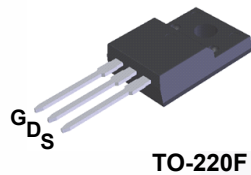
- $R_{DS(on)} = 290 \text{ m}\Omega$  (Max.) @  $V_{GS} = 10 \text{ V}$ ,  $I_D = 7 \text{ A}$
- Low Gate Charge (Typ. 18 nC)
- Low  $C_{rss}$  (Typ. 17 pF)
- 100% Avalanche Tested
- Improved dv/dt Capability

### Applications

- PDP TV
- Uninterruptible Power Supply

### Description

UniFET™ MOSFET is Fairchild Semiconductor's high voltage MOSFET family based on planar stripe and DMOS technology. This MOSFET is tailored to reduce on-state resistance, and to provide better switching performance and higher avalanche energy strength. This device family is suitable for switching power converter applications such as power factor correction (PFC), flat panel display (FPD) TV power, ATX and electronic lamp ballasts.



### Absolute Maximum Ratings $T_C = 25^\circ\text{C}$ unless otherwise noted.

| Symbol         | Parameter  | FDPF14N30                                  | Unit             |
|----------------|--|--|------------------|
| $V_{DSS}$      | Drain-Source Voltage   | 300  | V                |
| $I_D$          | Drain Current  | - Continuous ( $T_C = 25^\circ\text{C}$ )  | 14 *             |
|                |  | - Continuous ( $T_C = 100^\circ\text{C}$ ) | 8.4 *            |
| $I_{DM}$       | Drain Current  | - Pulsed (Note 1)                          | 56 *             |
| $V_{GSS}$      | Gate-Source voltage  | $\pm 30$                                   | V                |
| $E_{AS}$       | Single Pulsed Avalanche Energy (Note 2)                              | 330  | mJ               |
| $I_{AR}$       | Avalanche Current (Note 1)   | 14   | A                |
| $E_{AR}$       | Repetitive Avalanche Energy (Note 1)                                 | 14   | mJ               |
| dv/dt          | Peak Diode Recovery dv/dt (Note 3)                                   | 4.5  | V/ns             |
| $P_D$          | Power Dissipation  | ( $T_C = 25^\circ\text{C}$ )               | 35               |
|                |  | - Derate above $25^\circ\text{C}$          | 0.28             |
| $T_J, T_{STG}$ | Operating and Storage Temperature Range                              | -55 to +150                                | $^\circ\text{C}$ |
| $T_L$          | Maximum Lead Temperature for Soldering, 1/8" from Case for 5 Seconds | 300  | $^\circ\text{C}$ |

\*Drain current limited by maximum junction temperature.

### Thermal Characteristics

| Symbol          | Parameter                                     | FDPF14N30 | Unit                      |
|-----------------|---|-----------|---------------------------|
| $R_{\theta JC}$ | Thermal Resistance, Junction-to-Case, Max.    | 3.56      | $^\circ\text{C}/\text{W}$ |
| $R_{\theta JA}$ | Thermal Resistance, Junction-to-Ambient, Max. | 62.5      |                           |

## Package Marking and Ordering Information

| Part Number | Top Mark  | Package | Packing Method | Reel Size | Tape Width | Quantity |
|-------------|-----------|---------|----------------|-----------|------------|----------|
| FDPF14N30   | FDPF14N30 | TO-220F | Tube           | N/A       | N/A        | 50 units |

## Electrical Characteristics $T_C = 25^\circ\text{C}$ unless otherwise noted.

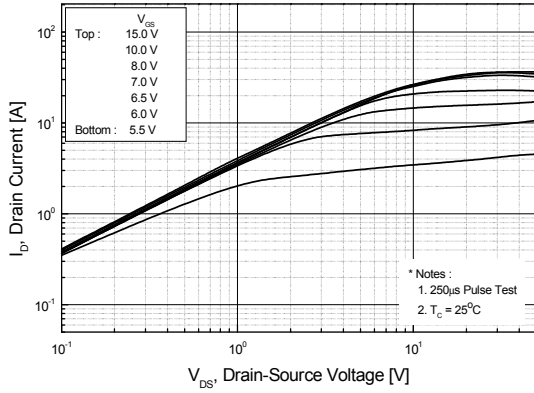
| Symbol  | Parameter   | Conditions   | Min.     | Typ. | Max.    | Unit                           |
|---|---|--|----------|------|---------|--------------------------------|
| <b>Off Characteristics</b>                                    |   |  |          |      |         |                                |
| $BV_{DSS}$  | Drain-Source Breakdown Voltage                        | $V_{GS} = 0\text{ V}, I_D = 250\ \mu\text{A}$  | 300      | --   | --      | V                              |
| $\Delta BV_{DSS} / \Delta T_J$                                | Breakdown Voltage Temperature Coefficient             | $I_D = 250\ \mu\text{A}$ , Referenced to $25^\circ\text{C}$                                      | --       | 0.3  | --      | $\text{V}/^\circ\text{C}$      |
| $I_{DSS}$   | Zero Gate Voltage Drain Current                       | $V_{DS} = 300\text{ V}, V_{GS} = 0\text{ V}$<br>$V_{DS} = 240\text{ V}, T_C = 125^\circ\text{C}$ | --       | --   | 1<br>10 | $\mu\text{A}$<br>$\mu\text{A}$ |
| $I_{GSSF}$  | Gate-Body Leakage Current, Forward                    | $V_{GS} = 30\text{ V}, V_{DS} = 0\text{ V}$  | --       | --   | 100     | nA                             |
| $I_{GSSR}$  | Gate-Body Leakage Current, Reverse                    | $V_{GS} = -30\text{ V}, V_{DS} = 0\text{ V}$   | --       | --   | -100    | nA                             |
| <b>On Characteristics</b>                                     |   |  |          |      |         |                                |
| $V_{GS(th)}$  | Gate Threshold Voltage                                | $V_{DS} = V_{GS}, I_D = 250\ \mu\text{A}$  | 3.0      | --   | 5.0     | V                              |
| $R_{DS(on)}$  | Static Drain-Source On-Resistance                     | $V_{GS} = 10\text{ V}, I_D = 7\text{ A}$   | --       | 0.24 | 0.29    | $\Omega$                       |
| $g_{FS}$  | Forward Transconductance                              | $V_{DS} = 40\text{ V}, I_D = 7\text{ A}$   | --       | 10.5 | --      | S                              |
| <b>Dynamic Characteristics</b>                                |   |  |          |      |         |                                |
| $C_{ISS}$   | Input Capacitance                                     | $V_{DS} = 25\text{ V}, V_{GS} = 0\text{ V},$<br>$f = 1.0\text{ MHz}$                             | --       | 815  | 1060    | pF                             |
| $C_{OSS}$   | Output Capacitance                                    |  | --       | 150  | 195     | pF                             |
| $C_{RSS}$   | Reverse Transfer Capacitance                          |  | --       | 17   | 25      | pF                             |
| <b>Switching Characteristics</b>                              |   |  |          |      |         |                                |
| $t_{d(on)}$   | Turn-On Delay Time                                    | $V_{DD} = 150\text{ V}, I_D = 14\text{ A},$<br>$V_{GS} = 10\text{ V}, R_G = 25\ \Omega$          | --       | 20   | 50      | ns                             |
| $t_r$   | Turn-On Rise Time                                     |  | --       | 105  | 120     | ns                             |
| $t_{d(off)}$  | Turn-Off Delay Time                                   |  | --       | 30   | 70      | ns                             |
| $t_f$   | Turn-Off Fall Time                                    |  | (Note 4) | --   | 75      | 160                            |
| $Q_g$   | Total Gate Charge                                     | $V_{DS} = 240\text{ V}, I_D = 14\text{ A},$<br>$V_{GS} = 10\text{ V}$                            | --       | 18   | 25      | nC                             |
| $Q_{gs}$  | Gate-Source Charge                                    |  | --       | 4.5  | --      | nC                             |
| $Q_{gd}$  | Gate-Drain Charge                                     |  | (Note 4) | --   | 8       | --                             |
| <b>Drain-Source Diode Characteristics and Maximum Ratings</b> |   |  |          |      |         |                                |
| $I_S$   | Maximum Continuous Drain-Source Diode Forward Current |  | --       | --   | 14      | A                              |
| $I_{SM}$  | Maximum Pulsed Drain-Source Diode Forward Current     |  | --       | --   | 56      | A                              |
| $V_{SD}$  | Drain-Source Diode Forward Voltage                    | $V_{GS} = 0\text{ V}, I_S = 14\text{ A}$   | --       | --   | 1.4     | V                              |
| $t_{rr}$  | Reverse Recovery Time                                 | $V_{GS} = 0\text{ V}, I_S = 14\text{ A},$<br>$di_f/dt = 100\text{ A}/\mu\text{s}$                | --       | 235  | --      | ns                             |
| $Q_{rr}$  | Reverse Recovery Charge                               |  | --       | 1.6  | --      | $\mu\text{C}$                  |

### Notes:

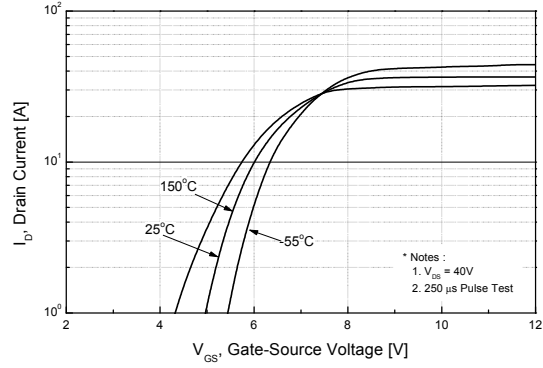
1. Repetitive rating: pulse-width limited by maximum junction temperature.
2.  $L = 2.8\text{ mH}, I_{AS} = 14\text{ A}, V_{DD} = 50\text{ V}, R_G = 25\ \Omega$ , starting  $T_J = 25^\circ\text{C}$ .
3.  $I_{SD} \leq 14\text{ A}, di/dt \leq 200\text{ A}/\mu\text{s}, V_{DD} \leq BV_{DSS}$ , starting  $T_J = 25^\circ\text{C}$ .
4. Essentially independent of operating temperature typical characteristics.

## Typical Performance Characteristics

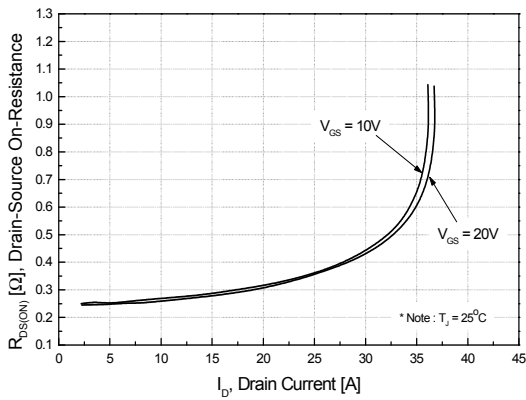
**Figure 1. On-Region Characteristics**



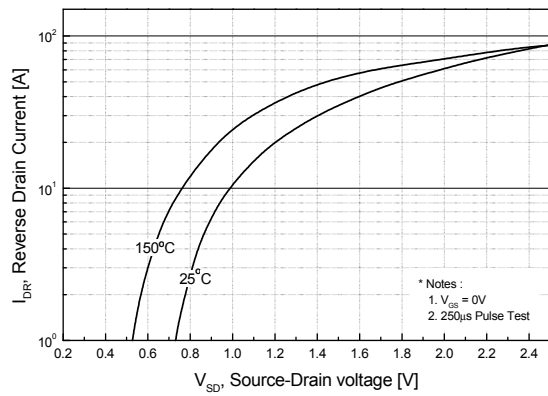
**Figure 2. Transfer Characteristics**



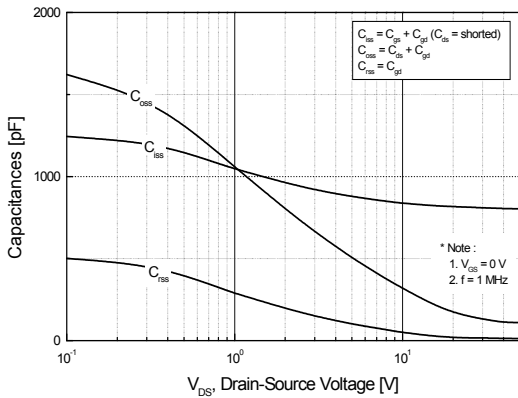
**Figure 3. On-Resistance Variation vs. Drain Current and Gate Voltage**



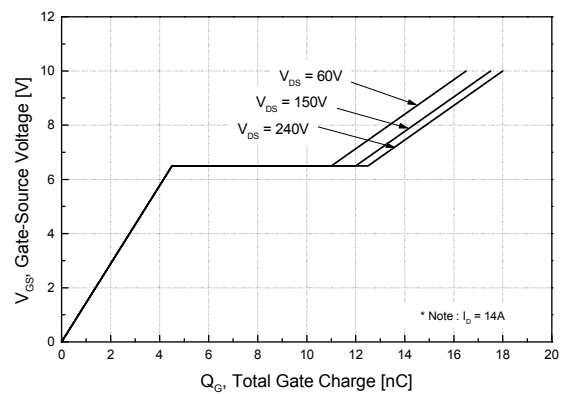
**Figure 4. Body Diode Forward Voltage Variation vs. Source Current and Temperature**



**Figure 5. Capacitance Characteristics**

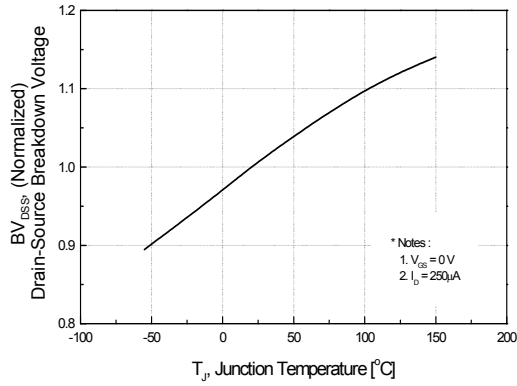


**Figure 6. Gate Charge Characteristics**

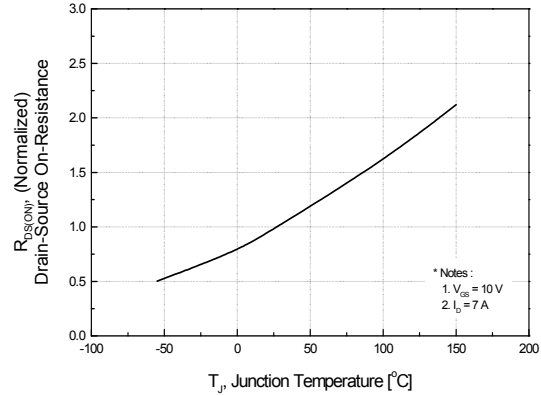


**Typical Performance Characteristics** (Continued)

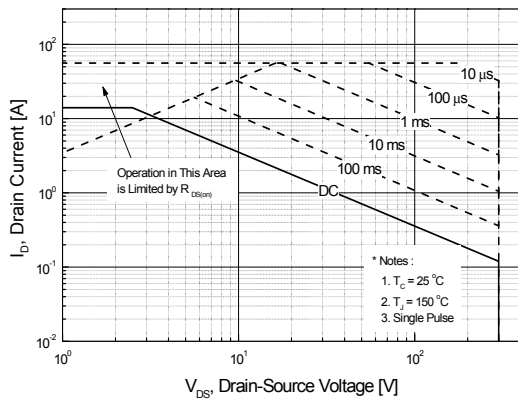
**Figure 7. Breakdown Voltage Variation vs. Temperature**



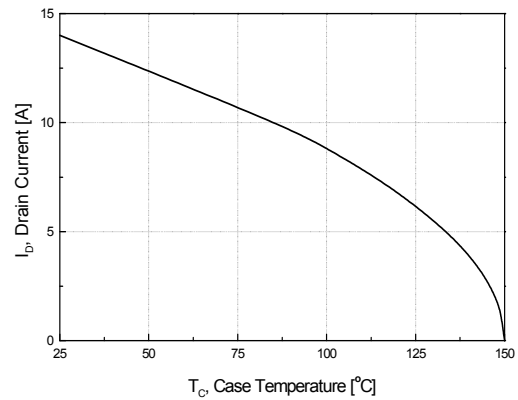
**Figure 8. On-Resistance Variation vs. Temperature**



**Figure 9. Maximum Safe Operating Area**



**Figure 10. Maximum Drain Current vs. Case Temperature**



**Figure 11. Transient Thermal Response Curve**

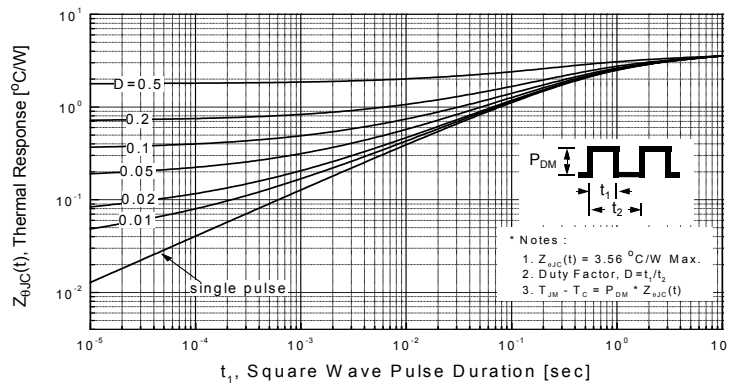




Figure 12. Gate Charge Test Circuit & Waveform



Figure 13. Resistive Switching Test Circuit & Waveforms

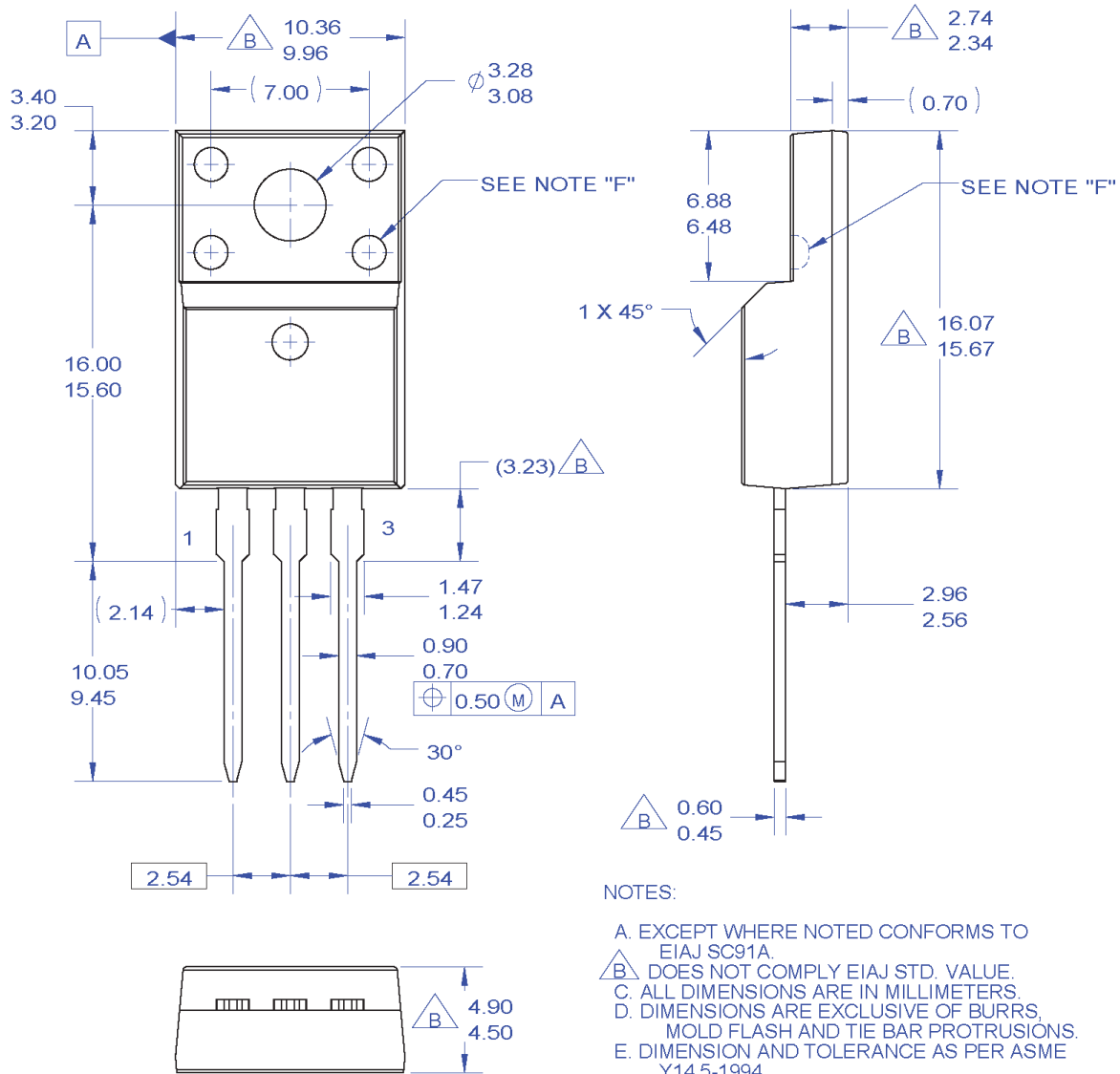


Figure 14. Unclamped Inductive Switching Test Circuit & Waveforms



Figure 15. Peak Diode Recovery  $dv/dt$  Test Circuit & Waveforms

**Mechanical Dimensions**



**NOTES:**

- A. EXCEPT WHERE NOTED CONFORMS TO EIAJ SC91A.
- B. DOES NOT COMPLY EIAJ STD. VALUE.
- C. ALL DIMENSIONS ARE IN MILLIMETERS.
- D. DIMENSIONS ARE EXCLUSIVE OF BURRS, MOLD FLASH AND TIE BAR PROTRUSIONS.
- E. DIMENSION AND TOLERANCE AS PER ASME Y14.5-1994.
- F. OPTION 1 - WITH SUPPORT PIN HOLE.  
OPTION 2 - NO SUPPORT PIN HOLE.
- G. DRAWING FILE NAME: TO220M03REV3

**Figure 16. TO220, Molded, 3-Lead, Full Pack, EIAJ SC91, Straight Lead**

Package drawings are provided as a service to customers considering Fairchild components. Drawings may change in any manner without notice. Please note the revision and/or date on the drawing and contact a Fairchild Semiconductor representative to verify or obtain the most recent revision. Package specifications do not expand the terms of Fairchild's worldwide terms and conditions, specifically the warranty therein, which covers Fairchild products.

Always visit Fairchild Semiconductor's online packaging area for the most recent package drawings:

[http://www.fairchildsemi.com/package/packageDetails.html?id=PN\\_TF220-003](http://www.fairchildsemi.com/package/packageDetails.html?id=PN_TF220-003)





# Mouser Electronics

Authorized Distributor

Click to View Pricing, Inventory, Delivery & Lifecycle Information:

[Fairchild Semiconductor:](#)

[FDPF14N30](#)