



Is Now Part of



ON Semiconductor®

To learn more about ON Semiconductor, please visit our website at

www.onsemi.com

ON Semiconductor and the ON Semiconductor logo are trademarks of Semiconductor Components Industries, LLC dba ON Semiconductor or its subsidiaries in the United States and/or other countries. ON Semiconductor owns the rights to a number of patents, trademarks, copyrights, trade secrets, and other intellectual property. A listing of ON Semiconductor's product/patent coverage may be accessed at www.onsemi.com/site/pdf/Patent-Marking.pdf. ON Semiconductor reserves the right to make changes without further notice to any products herein. ON Semiconductor makes no warranty, representation or guarantee regarding the suitability of its products for any particular purpose, nor does ON Semiconductor assume any liability arising out of the application or use of any product or circuit, and specifically disclaims any and all liability, including without limitation special, consequential or incidental damages. Buyer is responsible for its products and applications using ON Semiconductor products, including compliance with all laws, regulations and safety requirements or standards, regardless of any support or applications information provided by ON Semiconductor. "Typical" parameters which may be provided in ON Semiconductor data sheets and/or specifications can and do vary in different applications and actual performance may vary over time. All operating parameters, including "Typicals" must be validated for each customer application by customer's technical experts. ON Semiconductor does not convey any license under its patent rights nor the rights of others. ON Semiconductor products are not designed, intended, or authorized for use as a critical component in life support systems or any FDA Class 3 medical devices or medical devices with a same or similar classification in a foreign jurisdiction or any devices intended for implantation in the human body. Should Buyer purchase or use ON Semiconductor products for any such unintended or unauthorized application, Buyer shall indemnify and hold ON Semiconductor and its officers, employees, subsidiaries, affiliates, and distributors harmless against all claims, costs, damages, and expenses, and reasonable attorney fees arising out of, directly or indirectly, any claim of personal injury or death associated with such unintended or unauthorized use, even if such claim alleges that ON Semiconductor was negligent regarding the design or manufacture of the part. ON Semiconductor is an Equal Opportunity/Affirmative Action Employer. This literature is subject to all applicable copyright laws and is not for resale in any manner.

GBPC 12, 15, 25, 35 SERIES Bridge Rectifiers (Glass Passivated)

Features

- Integrally molded heat-sink provided very low thermal resistance for maximum heat dissipation.
- Surge Overload Ratings from 300 A to 400 A.
- Isolated voltage from case to lead over 2500 V.
- UL certified, UL #E258596
- Terminals Finish Material - Silver (Solderable per MIL-STD-202, Method 208 for the wire type GBPC-W package)
- Nickel for GBPC package.

Suffix “W”

- Wire Lead Structure

Suffix “M”

- Terminal Location Face to Face



Ordering Informations

Part Number	Marking	Package	Packing Method		
GBPC12005	GBPC12005	GBPC 4L	Bulk		
GBPC1201	GBPC1201				
GBPC1202	GBPC1202				
GBPC1204	GBPC1204				
GBPC1206	GBPC1206				
GBPC1208	GBPC1208				
GBPC1210	GBPC1210				
GBPC15005	GBPC15005				
GBPC1501	GBPC1501				
GBPC1502	GBPC1502				
GBPC1504	GBPC1504				
GBPC1506	GBPC1506				
GBPC1508	GBPC1508				
GBPC1510	GBPC1510				
GBPC25005	GBPC25005				
GBPC2501	GBPC2501				
GBPC2502	GBPC2502				
GBPC2504	GBPC2504				
GBPC2506	GBPC2506				
GBPC2508	GBPC2508				
GBPC2510	GBPC2510				
GBPC35005	GBPC35005				
GBPC3501	GBPC3501				
GBPC3502	GBPC3502				
GBPC3504	GBPC3504				
GBPC3506	GBPC3506				
GBPC3508	GBPC3508				
GBPC3510	GBPC3510				
GBPC1201W	GBPC1201W			GBPC-W 4L	Bulk
GBPC1202W	GBPC1202W				
GBPC1204W	GBPC1204W				
GBPC1206W	GBPC1206W				
GBPC1208W	GBPC1208W				
GBPC1210W	GBPC1210W				
GBPC15005W	GBPC15005W				
GBPC1501W	GBPC1501W				
GBPC1502W	GBPC1502W				
GBPC1504W	GBPC1504W				
GBPC1506W	GBPC1506W				
GBPC1508W	GBPC1508W				

Ordering Informations (continued)

Part Number	Marking	Package	Packing Method
GBPC1510W	GBPC1510W	GBPC-W 4L	Bulk
GBPC25005W	GBPC25005W		
GBPC2501W	GBPC2501W		
GBPC2502W	GBPC2502W		
GBPC2504W	GBPC2504W		
GBPC2506W	GBPC2506W		
GBPC2508W	GBPC2508W		
GBPC2510W	GBPC2510W		
GBPC35005W	GBPC35005W		
GBPC3501W	GBPC3501W		
GBPC3502W	GBPC3502W		
GBPC3504W	GBPC3504W		
GBPC3506W	GBPC3506W		
GBPC3508W	GBPC3508W		
GBPC3510W	GBPC3510W		

Absolute Maximum Ratings⁽¹⁾

Stresses exceeding the absolute maximum ratings may damage the device. The device may not function or be operable above the recommended operating conditions and stressing the parts to these levels is not recommended. In addition, extended exposure to stresses above the recommended operating conditions may affect device reliability. The absolute maximum ratings are stress ratings only. Values are at $T_A = 25^\circ\text{C}$ unless otherwise noted.

Symbol	Parameter	Value							Units
		005	01	02	04	06	08	10	
V_{RRM}	Maximum Repetitive Reverse Voltage	50	100	200	400	600	800	1000	V
V_{RMS}	Maximum RMS Bridge Input Voltage	35	70	140	280	420	560	700	V
V_R	DC Reverse Voltage (Rated V_R)	50	100	200	400	600	800	1000	V
$I_{F(AV)}$	Average Rectified Forward Current at $T_C = 55^\circ\text{C}$	GBPC12	12						A
		GBPC15	15						
		GBPC25	25						
		GBPC35	35						
I_{FSM}	Non-Repetitive Peak Forward Surge Current	GBPC12, 15, 25	300						A
	8.3ms Single Half-Sine-Wave	GBPC35	400						A
T_{STG}	Storage Temperature Range	-55 to +150							$^\circ\text{C}$
T_J	Operating Junction Temperature	-55 to +150							$^\circ\text{C}$

Note:

1. These ratings are limiting values above which the serviceability of any semiconductor device may be impaired.

Thermal Characteristics

Values are at $T_A = 25^\circ\text{C}$ unless otherwise noted.

Symbol	Parameter	Value	Units
P_D	Power Dissipation	83.3	W
$R_{\theta JC}$	Thermal Resistance, Junction to Case ⁽²⁾	1.5	$^\circ\text{C/W}$

Note:

2. With Heatsink.

Electrical Characteristics

Values are at $T_A = 25^\circ\text{C}$ unless otherwise noted.

Symbol	Parameter	Test Conditions	Value	Units
V_F	Forward Voltage Drop, per bridge	6.0 A GBPC12	1.1 (Max)	V
		7.5 A GBPC15		
		12.5 A GBPC25		
		17.5 A GBPC35		
I_R	Reverse Current, per element at Rated V_R	$T_A = 25^\circ\text{C}$	5.0 (Max)	μA
		$T_A = 125^\circ\text{C}$	500 (Max)	μA
I^2t	Rating for Fusing $t < 8.35$ ms	GBPC12, 15, 25	375	A^2Sec
		GBPC35	660	A^2Sec
C_T	Total Capacitance, per leg $V_R = 4.0$ V $f = 1.0$ MHz	GBPC12, 15, 25	180	pF
		GBPC35	200	pF

Typical Performance Characteristics

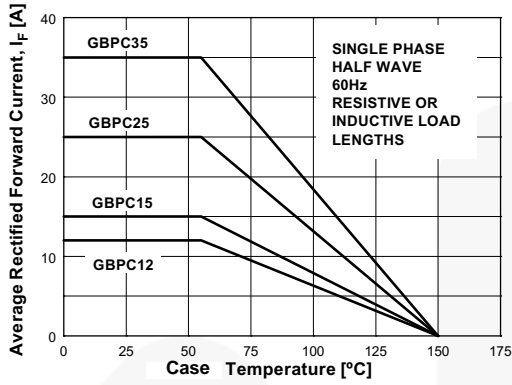

Figure 1. Forward Current Derating Curve

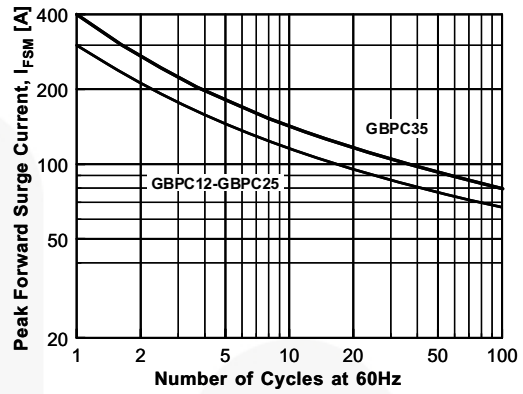

Figure 2. Non-Repetitive Surge Current

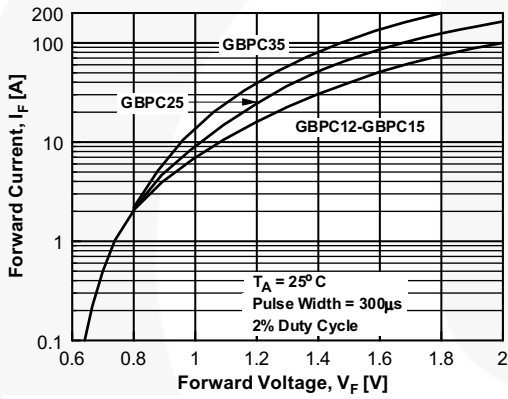

Figure 3. Forward Voltage Characteristics

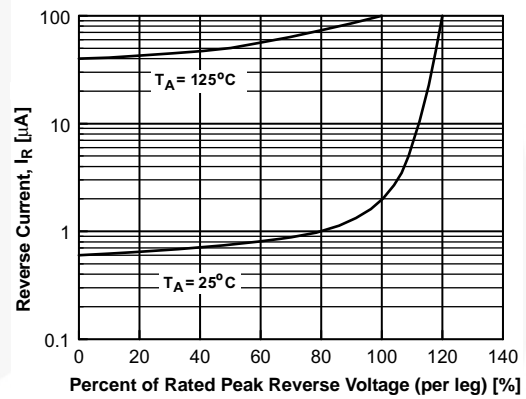
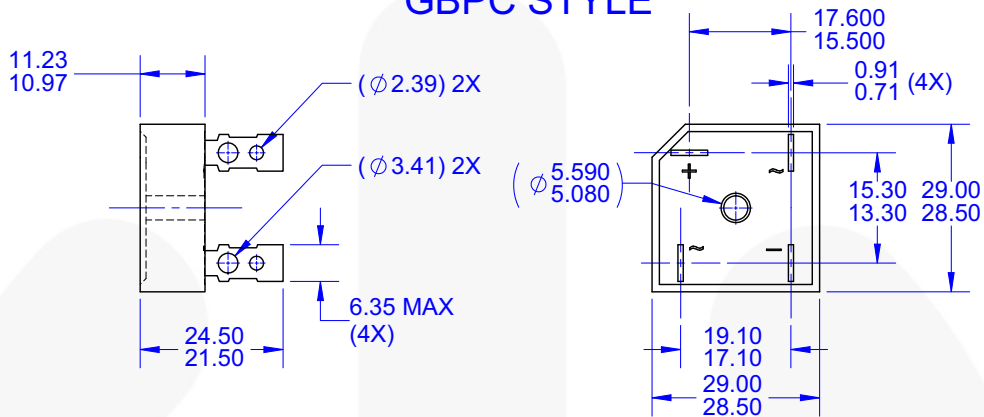

Figure 4. Reverse Current vs. Reverse Voltage

Physical Dimension

GBPC

GBPC STYLE



GBPC-W STYLE

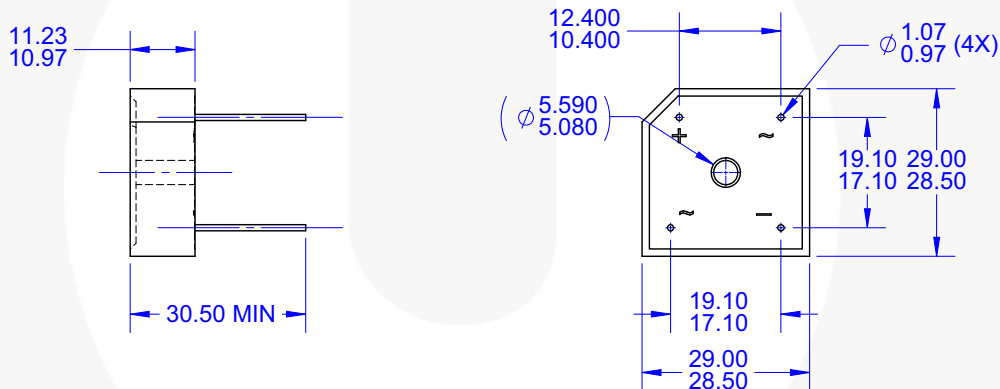

NOTES:

- A. THIS PACKAGE DOES NOT CONFORM TO ANY STANDARDS.
- B. ALL DIMENSIONS ARE IN MILLIMETERS.
- C. DIMENSIONS ARE EXCLUSIVE OF BURRS, MOLD FLASH AND TIE BAR PROTRUSIONS.
- D. FAIRCHILD SEMICONDUCTOR
- E. DRAWING FILE NAME: MKT-GBPC04A REV3

Figure 5. 4-TERMINAL, COMBINATION GBPC AND GBPC-W (ACTIVE)





Package drawings are provided as a service to customers considering Fairchild components. Drawings may change in any manner without notice. Please note the revision and/or date on the drawing and contact a Fairchild Semiconductor representative to verify or obtain the most recent revision. Package specifications do not expand the terms of Fairchild's worldwide terms and conditions, specifically the warranty therein, which covers Fairchild products.

Always visit Fairchild Semiconductor's online packaging area for the most recent package drawings:
<http://www.fairchildsemi.com/dwg/GB/GBPC04A.pdf>



TRADEMARKS

The following includes registered and unregistered trademarks and service marks, owned by Fairchild Semiconductor and/or its global subsidiaries, and is not intended to be an exhaustive list of all such trademarks.

AccuPower™	F-PFS™		Sync-Lock™
AX-CAP®*	FRFET®	PowerTrench®	
BitSiC™	Global Power Resource™	PowerXS™	TinyBoost®
Build it Now™	GreenBridge™	Programmable Active Droop™	TinyBuck®
CorePLUS™	Green FPS™	QFET®	TinyCalc™
CorePOWER™	Green FPS™ e-Series™	QS™	TinyLogic®
CROSSVOLT™	Gmax™	Quiet Series™	TINYOPTO™
CTL™	GTO™	RapidConfigure™	TinyPower™
Current Transfer Logic™	IntelliMAX™		TinyPWM™
DEUXPEED®	ISOPLANAR™	Saving our world, 1mW/W/kW at a time™	TinyWire™
Dual Cool™	Making Small Speakers Sound Louder and Better™	SignalWise™	TranSiC™
EcoSPARK®	MegaBuck™	SmartMax™	TriFault Detect™
EfficientMax™	MICROCOUPLER™	SMART START™	TRUECURRENT®*
ESBC™	MicroFET™	Solutions for Your Success™	µSerDes™
	MicroPak™	SPM®	
Fairchild®	MicroPak2™	STEALTH™	UHC®
Fairchild Semiconductor®	MillerDrive™	SuperFET®	Ultra FRFET™
FACT Quiet Series™	MotionMax™	SuperSOT™-3	UniFET™
FACT®	mWSaver®	SuperSOT™-6	VCX™
FAST®	OptoHiT™	SuperSOT™-8	VisualMax™
FastvCore™	OPTOLOGIC®	SupreMOS®	VoltagePlus™
FETBench™	OPTOPLANAR®	SyncFET™	XS™
FPS™			

* Trademarks of System General Corporation, used under license by Fairchild Semiconductor.

DISCLAIMER

FAIRCHILD SEMICONDUCTOR RESERVES THE RIGHT TO MAKE CHANGES WITHOUT FURTHER NOTICE TO ANY PRODUCTS HEREIN TO IMPROVE RELIABILITY, FUNCTION, OR DESIGN. FAIRCHILD DOES NOT ASSUME ANY LIABILITY ARISING OUT OF THE APPLICATION OR USE OF ANY PRODUCT OR CIRCUIT DESCRIBED HEREIN; NEITHER DOES IT CONVEY ANY LICENSE UNDER ITS PATENT RIGHTS, NOR THE RIGHTS OF OTHERS. THESE SPECIFICATIONS DO NOT EXPAND THE TERMS OF FAIRCHILD'S WORLDWIDE TERMS AND CONDITIONS, SPECIFICALLY THE WARRANTY THEREIN, WHICH COVERS THESE PRODUCTS.

LIFE SUPPORT POLICY

FAIRCHILD'S PRODUCTS ARE NOT AUTHORIZED FOR USE AS CRITICAL COMPONENTS IN LIFE SUPPORT DEVICES OR SYSTEMS WITHOUT THE EXPRESS WRITTEN APPROVAL OF FAIRCHILD SEMICONDUCTOR CORPORATION.

As used herein:

1. Life support devices or systems are devices or systems which, (a) are intended for surgical implant into the body or (b) support or sustain life, and (c) whose failure to perform when properly used in accordance with instructions for use provided in the labeling, can be reasonably expected to result in a significant injury of the user.
2. A critical component in any component of a life support, device, or system whose failure to perform can be reasonably expected to cause the failure of the life support device or system, or to affect its safety or effectiveness.

ANTI-COUNTERFEITING POLICY

Fairchild Semiconductor Corporation's Anti-Counterfeiting Policy. Fairchild's Anti-Counterfeiting Policy is also stated on our external website, www.fairchildsemi.com, under Sales Support.

Counterfeiting of semiconductor parts is a growing problem in the industry. All manufacturers of semiconductor products are experiencing counterfeiting of their parts. Customers who inadvertently purchase counterfeit parts experience many problems such as loss of brand reputation, substandard performance, failed applications, and increased cost of production and manufacturing delays. Fairchild is taking strong measures to protect ourselves and our customers from the proliferation of counterfeit parts. Fairchild strongly encourages customers to purchase Fairchild parts either directly from Fairchild or from Authorized Fairchild Distributors who are listed by country on our web page cited above. Products customers buy either from Fairchild directly or from Authorized Fairchild Distributors are genuine parts, have full traceability, meet Fairchild's quality standards for handling and storage and provide access to Fairchild's full range of up-to-date technical and product information. Fairchild and our Authorized Distributors will stand behind all warranties and will appropriately address any warranty issues that may arise. Fairchild will not provide any warranty coverage or other assistance for parts bought from Unauthorized Sources. Fairchild is committed to combat this global problem and encourage our customers to do their part in stopping this practice by buying direct or from authorized distributors.

PRODUCT STATUS DEFINITIONS

Definition of Terms

Datasheet Identification	Product Status	Definition
Advance Information	Formative / In Design	Datasheet contains the design specifications for product development. Specifications may change in any manner without notice.
Preliminary	First Production	Datasheet contains preliminary data; supplementary data will be published at a later date. Fairchild Semiconductor reserves the right to make changes at any time without notice to improve design.
No Identification Needed	Full Production	Datasheet contains final specifications. Fairchild Semiconductor reserves the right to make changes at any time without notice to improve the design.
Obsolete	Not In Production	Datasheet contains specifications on a product that is discontinued by Fairchild Semiconductor. The datasheet is for reference information only.

Mouser Electronics

Authorized Distributor

Click to View Pricing, Inventory, Delivery & Lifecycle Information:

[Fairchild Semiconductor:](#)

[GBPC1210](#) [GBPC1210W](#)