

MBR2535CT - MBR2560CT

25 A Schottky Barrier Rectifiers

Features

- Low Power Loss, High Efficiency
- High Surge Capacity
- Metal Silicon Junction, Majority Carrier Conduction
- High Current Capacity, Low Forward Voltage Drop
- Guard Ring for Over-Voltage Protection (OVP)

Applications

- Low-Voltage, High-Frequency Inverters
- Free Wheeling and Polarity Protection

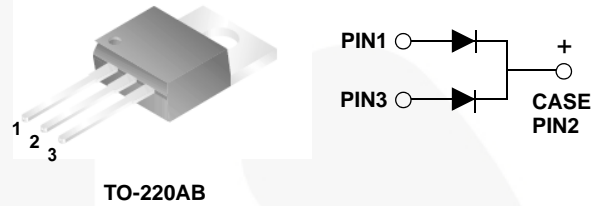

Absolute Maximum Ratings

Stresses exceeding the absolute maximum ratings may damage the device. The device may not function or be operable above the recommended operating conditions and stressing the parts to these levels is not recommended. In addition, extended exposure to stresses above the recommended operating conditions may affect device reliability. The absolute maximum ratings are stress ratings only. Values are at $T_A = 25^\circ\text{C}$ unless otherwise noted.

Symbol	Parameter	Value				Units
		2535CT	2545CT	2550CT	2560CT	
V_{RRM}	Maximum Repetitive Reverse Voltage	35	45	50	60	V
$I_{F(AV)}$	Average Rectified Forward Current .375 inch Lead Length at $T_A = 130^\circ\text{C}$	25				A
I_{FSM}	Non-Repetitive Peak Forward Surge Current 8.3 ms Single Half-Sine-Wave	200				A
T_{STG}	Storage Temperature Range	-65 to +175				$^\circ\text{C}$
T_J	Operating Junction Temperature Range	-65 to +150				$^\circ\text{C}$

Thermal Characteristics

Symbol	Parameter	Value	Units
P_D	Power Dissipation	2.0	W
$R_{\theta JA}$	Thermal Resistance, Junction to Ambient	60	$^\circ\text{C/W}$
$R_{\theta JL}$	Thermal Resistance, Junction to Lead	1.5	$^\circ\text{C/W}$

Electrical Characteristics

Values are at $T_A = 25^\circ\text{C}$ unless otherwise noted.

Symbol	Parameter	Value				Units
		2535CT	2545CT	2550CT	2560CT	
V_F	Maximum Forward Voltage, per Leg	$I_F = 12.5\text{A}, T_C = 25^\circ\text{C}$			0.75	V
		$I_F = 12.5\text{A}, T_C = 125^\circ\text{C}$			0.65	
		$I_F = 25\text{A}, T_C = 25^\circ\text{C}$	0.82			
		$I_F = 25\text{A}, T_C = 125^\circ\text{C}$	0.73			
I_R	Maximum Reverse Current at Rated V_{RRM} , per Leg	$T_A = 25^\circ\text{C}$	0.2		0.2	mA
		$T_A = 125^\circ\text{C}$	15.0		10.0	
I_{RRM}	Peak Repetitive Reverse Surge Current, per Leg 2.0 μs Pulse Width, $f = 1.0\text{ kHz}$		1.0		0.5	A
C_j	Typical Junction Capacitance, per Leg		600		460	pF

Typical Performance Characteristics

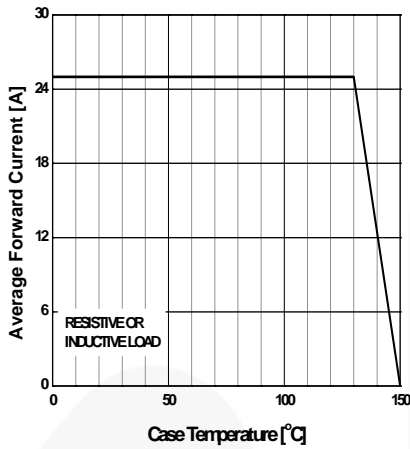

Figure 1. Forward Current Derating Curve

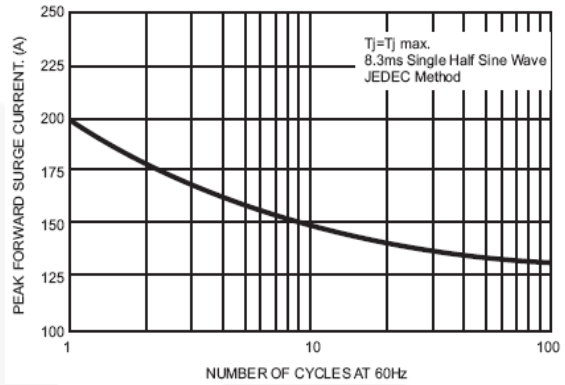

Figure 2. Non-Repetitive Surge Current, per Leg

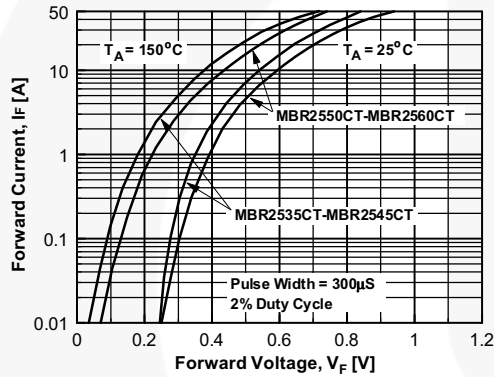

Figure 3. Forward Voltage Characteristics, per Leg

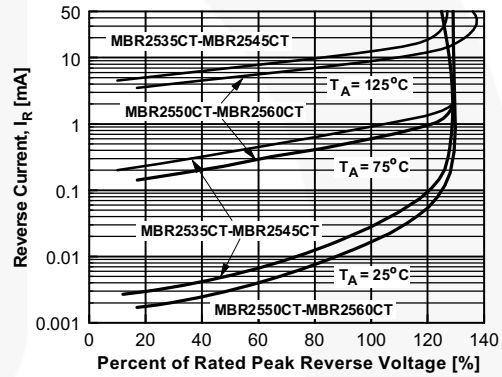

Figure 4. Reverse Current vs. Reverse Voltage, per Leg

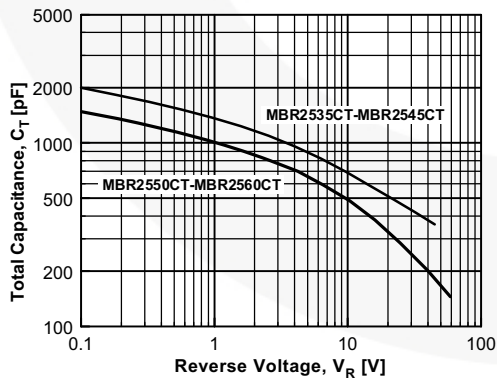

Figure 5. Total Capacitance, per Leg

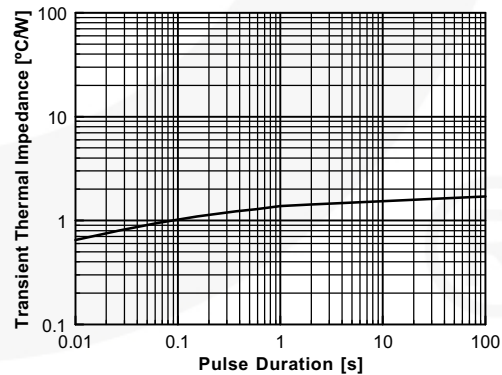

Figure 6. Thermal Impedance Characteristics

Physical Dimensions

TO-220 3L

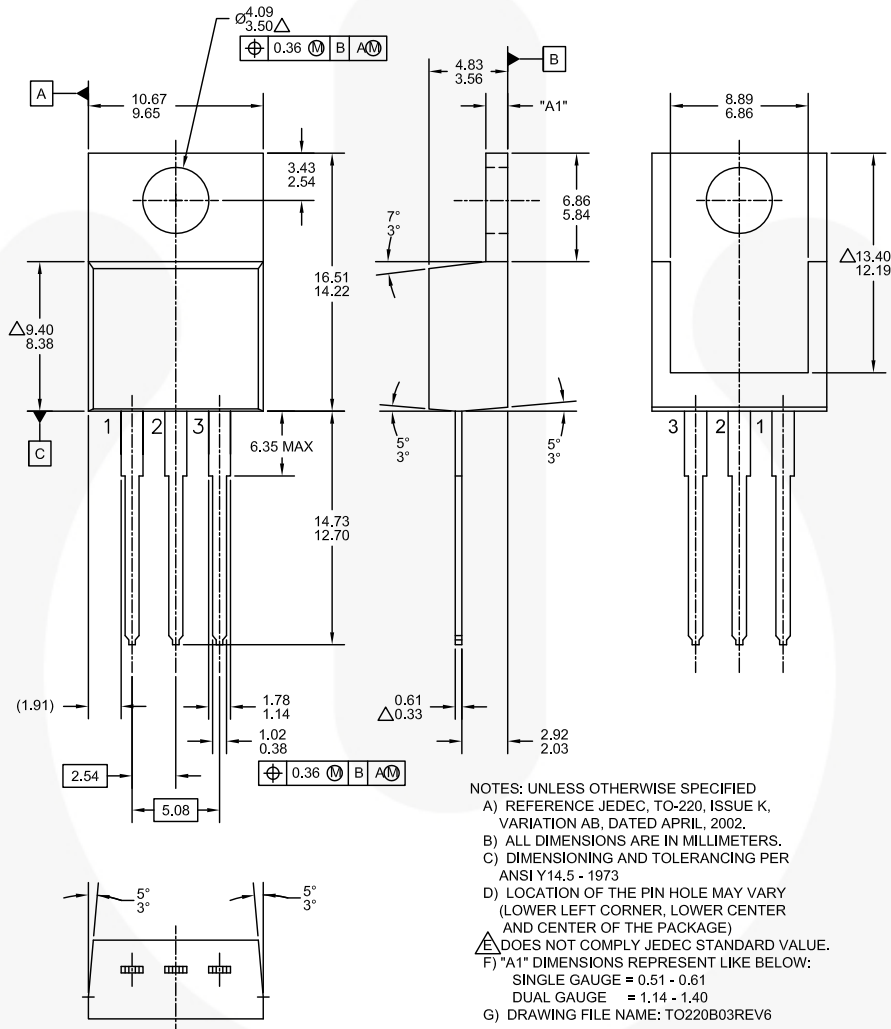

Figure 7. TO-220, MOLDED, 3-LEAD, JEDEC VARIATION AB (ACTIVE)

Package drawings are provided as a service to customers considering Fairchild components. Drawings may change in any manner without notice. Please note the revision and/or date on the drawing and contact a Fairchild Semiconductor representative to verify or obtain the most recent revision. Package specifications do not expand the terms of Fairchild's worldwide terms and conditions, specifically the warranty therein, which covers Fairchild products.

Always visit Fairchild Semiconductor's online packaging area for the most recent package drawings:

<http://www.fairchildsemi.com/packaging/>

For current tape and reel specifications, visit Fairchild Semiconductor's online packaging area:

http://www.fairchildsemi.com/packing_dwg/PKG-TO220B03_TC.pdf



TRADEMARKS

The following includes registered and unregistered trademarks and service marks, owned by Fairchild Semiconductor and/or its global subsidiaries, and is not intended to be an exhaustive list of all such trademarks.

- | | | | |
|---|--|---|---|
| 2Cool™ | FPS™ |  | Sync-Lock™ |
| AccuPower™ | F-PFS™ | PowerTrench® |  |
| AX-CAP®* | FRFET® | PowerXS™ | TinyBoost™ |
| BitSiC™ | Global Power Resource SM | Programmable Active Droop™ | TinyBuck™ |
| Build it Now™ | GreenBridge™ | QFET® | TinyCalc™ |
| CorePLUS™ | Green FPS™ | QS™ | TinyLogic® |
| CorePOWER™ | Green FPS™ e-Series™ | Quiet Series™ | TINYOPTO™ |
| CROSSVOLT™ | Gmax™ | RapidConfigure™ | TinyPower™ |
| CTL™ | GTO™ |  | TinyPWM™ |
| Current Transfer Logic™ | IntelliMAX™ | Saving our world, 1mW/W/kW at a time™ | TinyWire™ |
| DEUXPEED® | ISOPLANAR™ | SignalWise™ | TranSiC™ |
| Dual Cool™ | Making Small Speakers Sound Louder and Better™ | SmartMax™ | TriFault Detect™ |
| EcoSPARK® | MegaBuck™ | SMART START™ | TRUECURRENT®* |
| EfficientMax™ | MICROCOUPLER™ | Solutions for Your Success™ | μSerDes™ |
| ESBC™ | MicroFET™ | SPM® |  |
|  | MicroPak™ | STEALTH™ | UHC® |
| Fairchild® | MicroPak2™ | SuperFET® | Ultra FRFET™ |
| Fairchild Semiconductor® | MillerDrive™ | SuperSOT™-3 | UniFET™ |
| FACT Quiet Series™ | MotionMax™ | SuperSOT™-6 | VCX™ |
| FACT® | mWSaver™ | SuperSOT™-8 | VisualMax™ |
| FAST® | OptoHiT™ | SupreMOS® | VoltagePlus™ |
| FastvCore™ | OPTOLOGIC® | SyncFET™ | XS™ |
| FETBench™ | OPTOPLANAR® | | |

* Trademarks of System General Corporation, used under license by Fairchild Semiconductor.

DISCLAIMER

FAIRCHILD SEMICONDUCTOR RESERVES THE RIGHT TO MAKE CHANGES WITHOUT FURTHER NOTICE TO ANY PRODUCTS HEREIN TO IMPROVE RELIABILITY, FUNCTION, OR DESIGN. FAIRCHILD DOES NOT ASSUME ANY LIABILITY ARISING OUT OF THE APPLICATION OR USE OF ANY PRODUCT OR CIRCUIT DESCRIBED HEREIN; NEITHER DOES IT CONVEY ANY LICENSE UNDER ITS PATENT RIGHTS, NOR THE RIGHTS OF OTHERS. THESE SPECIFICATIONS DO NOT EXPAND THE TERMS OF FAIRCHILD'S WORLDWIDE TERMS AND CONDITIONS, SPECIFICALLY THE WARRANTY THEREIN, WHICH COVERS THESE PRODUCTS.

LIFE SUPPORT POLICY

FAIRCHILD'S PRODUCTS ARE NOT AUTHORIZED FOR USE AS CRITICAL COMPONENTS IN LIFE SUPPORT DEVICES OR SYSTEMS WITHOUT THE EXPRESS WRITTEN APPROVAL OF FAIRCHILD SEMICONDUCTOR CORPORATION.

As used herein:

1. Life support devices or systems are devices or systems which, (a) are intended for surgical implant into the body or (b) support or sustain life, and (c) whose failure to perform when properly used in accordance with instructions for use provided in the labeling, can be reasonably expected to result in a significant injury of the user.
2. A critical component in any component of a life support, device, or system whose failure to perform can be reasonably expected to cause the failure of the life support device or system, or to affect its safety or effectiveness.

ANTI-COUNTERFEITING POLICY

Fairchild Semiconductor Corporation's Anti-Counterfeiting Policy. Fairchild's Anti-Counterfeiting Policy is also stated on our external website, www.fairchildsemi.com, under Sales Support.

Counterfeiting of semiconductor parts is a growing problem in the industry. All manufacturers of semiconductor products are experiencing counterfeiting of their parts. Customers who inadvertently purchase counterfeit parts experience many problems such as loss of brand reputation, substandard performance, failed applications, and increased cost of production and manufacturing delays. Fairchild is taking strong measures to protect ourselves and our customers from the proliferation of counterfeit parts. Fairchild strongly encourages customers to purchase Fairchild parts either directly from Fairchild or from Authorized Fairchild Distributors who are listed by country on our web page cited above. Products customers buy either from Fairchild directly or from Authorized Fairchild Distributors are genuine parts, have full traceability, meet Fairchild's quality standards for handling and storage and provide access to Fairchild's full range of up-to-date technical and product information. Fairchild and our Authorized Distributors will stand behind all warranties and will appropriately address any warranty issues that may arise. Fairchild will not provide any warranty coverage or other assistance for parts bought from Unauthorized Sources. Fairchild is committed to combat this global problem and encourage our customers to do their part in stopping this practice by buying direct or from authorized distributors.

PRODUCT STATUS DEFINITIONS

Definition of Terms

Datasheet Identification	Product Status	Definition
Advance Information	Formative / In Design	Datasheet contains the design specifications for product development. Specifications may change in any manner without notice.
Preliminary	First Production	Datasheet contains preliminary data; supplementary data will be published at a later date. Fairchild Semiconductor reserves the right to make changes at any time without notice to improve design.
No Identification Needed	Full Production	Datasheet contains final specifications. Fairchild Semiconductor reserves the right to make changes at any time without notice to improve the design.
Obsolete	Not In Production	Datasheet contains specifications on a product that is discontinued by Fairchild Semiconductor. The datasheet is for reference information only.

Mouser Electronics

Authorized Distributor

Click to View Pricing, Inventory, Delivery & Lifecycle Information:

[Fairchild Semiconductor:](#)

[MBR2545CT](#) [MBR2545CT_Q](#)