

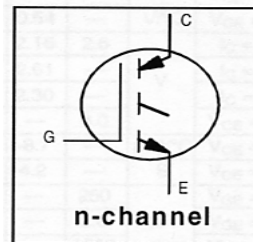
# IRG4RC10UPbF

## INSULATED GATE BIPOLAR TRANSISTOR

## UltraFast Speed IGBT

### Features

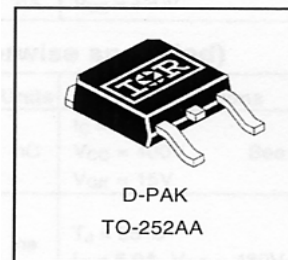
- UltraFast: Optimized for high operating frequencies ( 8-40 kHz in hard switching, >200 kHz in resonant mode)
- Generation 4 IGBT design provides tighter parameter distribution and higher efficiency than previous generation
- Industry standard TO-252AA package
- Lead-Free



$V_{CES} = 600V$
$V_{CE(on)} \text{ typ.} = 2.15V$
@ $V_{GE} = 15V, I_C = 5.0A$

### Benefits

- Generation 4 IGBT's offer highest efficiency available
- IGBT's optimized for specified application conditions



### Absolute Maximum Ratings

	Parameter	Max.	Units
$V_{CES}$	Collector-to-Emitter Voltage	600	V
$I_C @ T_C = 25^\circ C$	Continuous Collector Current	8.5	A
$I_C @ T_C = 100^\circ C$	Continuous Collector Current	5.0	
$I_{CM}$	Pulsed Collector Current ①	34	
$I_{LM}$	Clamped Inductive Load Current ②	34	
$V_{GE}$	Gate-to-Emitter Voltage	$\pm 20$	V
$E_{ARV}$	Reverse Voltage Avalanche Energy ③	110	mJ
$P_D @ T_C = 25^\circ C$	Maximum Power Dissipation	38	W
$P_D @ T_C = 100^\circ C$	Maximum Power Dissipation	15	
$T_J$	Operating Junction and	-55 to +150	°C
$T_{STG}$	Storage Temperature Range		
	Soldering Temperature, for 10 sec.	300 (0.063 in. (1.6mm) from case )	

### Thermal Resistance

	Parameter	Typ.	Max.	Units
$R_{\theta JC}$	Junction-to-Case	—	3.3	°C/W
$R_{\theta JA}$	Junction-to-Ambient (PCB mount)*	—	50	
Wt	Weight	0.3 (0.01)	—	g (oz)

\* When mounted on 1" square PCB (FR-4 or G-10 Material).

For recommended footprint and soldering techniques refer to application note #AN-994

## Electrical Characteristics @ T<sub>J</sub> = 25°C (unless otherwise specified)

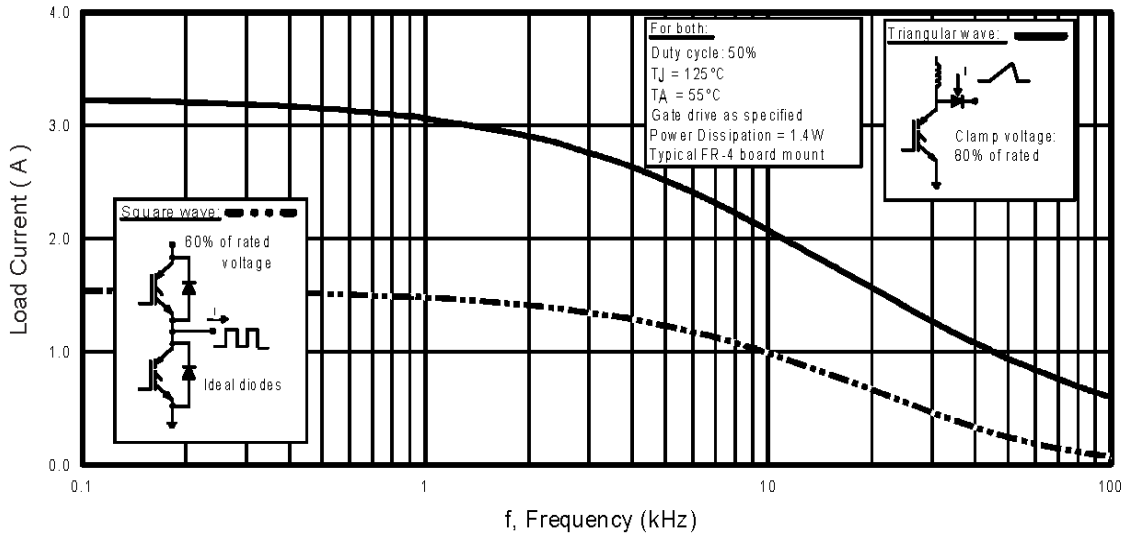
	Parameter	Min.	Typ.	Max.	Units	Conditions
V <sub>(BR)CES</sub>	Collector-to-Emitter Breakdown Voltage	600	—	—	V	V <sub>GE</sub> = 0V, I <sub>C</sub> = 250μA
V <sub>(BR)ECS</sub>	Emitter-to-Collector Breakdown Voltage ④	14	—	—	V	V <sub>GE</sub> = 0V, I <sub>C</sub> = 1.0A
ΔV <sub>(BR)CES/ΔT<sub>J</sub></sub>	Temperature Coeff. of Breakdown Voltage	—	0.54	—	V/°C	V <sub>GE</sub> = 0V, I <sub>C</sub> = 1.0mA
V <sub>CE(ON)</sub>	Collector-to-Emitter Saturation Voltage	—	2.15	2.6	V	I <sub>C</sub> = 5.0A V <sub>GE</sub> = 15V
		—	2.61	—		I <sub>C</sub> = 8.5A See Fig.2, 5
		—	2.30	—		I <sub>C</sub> = 5.0A, T <sub>J</sub> = 150°C
V <sub>GE(th)</sub>	Gate Threshold Voltage	3.0	—	6.0		V <sub>CE</sub> = V <sub>GE</sub> , I <sub>C</sub> = 250μA
ΔV <sub>GE(th)/ΔT<sub>J</sub></sub>	Temperature Coeff. of Threshold Voltage	—	-8.7	—	mV/°C	V <sub>CE</sub> = V <sub>GE</sub> , I <sub>C</sub> = 250μA
g <sub>fe</sub>	Forward Transconductance ⑤	2.8	4.2	—	S	V <sub>CE</sub> = 100V, I <sub>C</sub> = 5.0A
I <sub>CES</sub>	Zero Gate Voltage Collector Current	—	—	250	μA	V <sub>GE</sub> = 0V, V <sub>CE</sub> = 600V
		—	—	2.0		V <sub>GE</sub> = 0V, V <sub>CE</sub> = 10V, T <sub>J</sub> = 25°C
		—	—	1000		V <sub>GE</sub> = 0V, V <sub>CE</sub> = 600V, T <sub>J</sub> = 150°C
I <sub>GES</sub>	Gate-to-Emitter Leakage Current	—	—	±100	nA	V <sub>GE</sub> = ±20V

## Switching Characteristics @ T<sub>J</sub> = 25°C (unless otherwise specified)

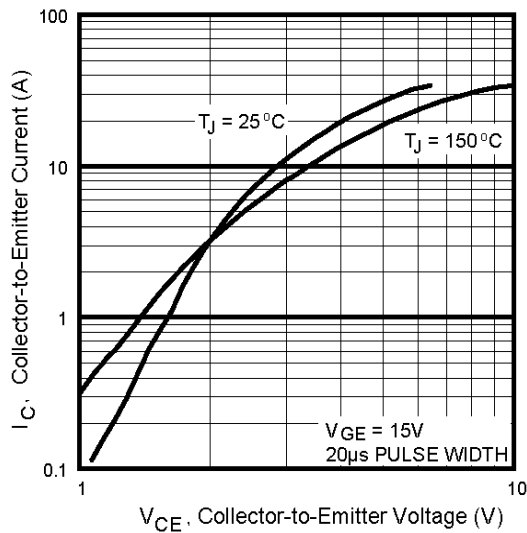
	Parameter	Min.	Typ.	Max.	Units	Conditions
Q <sub>g</sub>	Total Gate Charge (turn-on)	—	15	22	nC	I <sub>C</sub> = 5.0A
Q <sub>ge</sub>	Gate - Emitter Charge (turn-on)	—	2.6	4.0		V <sub>CC</sub> = 400V See Fig. 8
Q <sub>gc</sub>	Gate - Collector Charge (turn-on)	—	5.8	8.7		V <sub>GE</sub> = 15V
t <sub>d(on)</sub>	Turn-On Delay Time	—	19	—	ns	T <sub>J</sub> = 25°C I <sub>C</sub> = 5.0A, V <sub>CC</sub> = 480V V <sub>GE</sub> = 15V, R <sub>G</sub> = 100Ω Energy losses include "tail"
t <sub>r</sub>	Rise Time	—	11	—		
t <sub>d(off)</sub>	Turn-Off Delay Time	—	116	240		
t <sub>f</sub>	Fall Time	—	81	180		
E <sub>on</sub>	Turn-On Switching Loss	—	0.08	—		
E <sub>off</sub>	Turn-Off Switching Loss	—	0.16	—	mJ	See Fig. 9, 10, 14
E <sub>ts</sub>	Total Switching Loss	—	0.24	0.36		
t <sub>d(on)</sub>	Turn-On Delay Time	—	18	—	ns	T <sub>J</sub> = 150°C, I <sub>C</sub> = 5.0A, V <sub>CC</sub> = 480V V <sub>GE</sub> = 15V, R <sub>G</sub> = 100Ω Energy losses include "tail"
t <sub>r</sub>	Rise Time	—	14	—		
t <sub>d(off)</sub>	Turn-Off Delay Time	—	180	—		
t <sub>f</sub>	Fall Time	—	150	—		
E <sub>ts</sub>	Total Switching Loss	—	0.36	—	mJ	See Fig. 11, 14
L <sub>E</sub>	Internal Emitter Inductance	—	7.5	—	nH	Measured 5mm from package
C <sub>ies</sub>	Input Capacitance	—	270	—	pF	V <sub>GE</sub> = 0V V <sub>CC</sub> = 30V See Fig. 7 f = 1.0MHz
C <sub>oes</sub>	Output Capacitance	—	21	—		
C <sub>res</sub>	Reverse Transfer Capacitance	—	3.5	—		

### Notes:

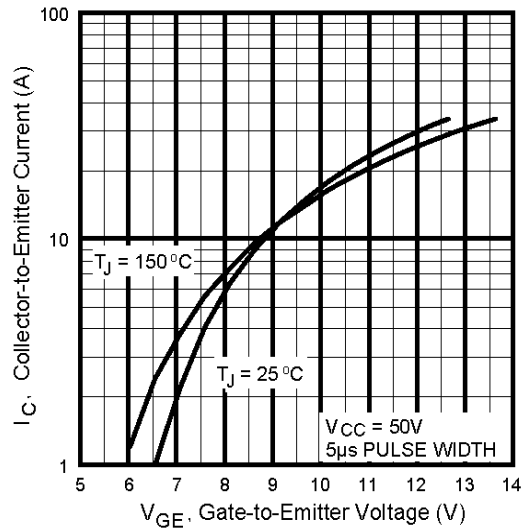
- ① Repetitive rating; V<sub>GE</sub> = 20V, pulse width limited by max. junction temperature. ( See fig. 13b )
- ② V<sub>CC</sub> = 80%(V<sub>CES</sub>), V<sub>GE</sub> = 20V, L = 10μH, R<sub>G</sub> = 100Ω, (See fig. 13a)
- ③ Repetitive rating; pulse width limited by maximum junction temperature.
- ④ Pulse width ≤ 80μs; duty factor ≤ 0.1%.
- ⑤ Pulse width 5.0μs, single shot.



**Fig. 1** - Typical Load Current vs. Frequency  
 (Load Current =  $I_{RMS}$  of fundamental)



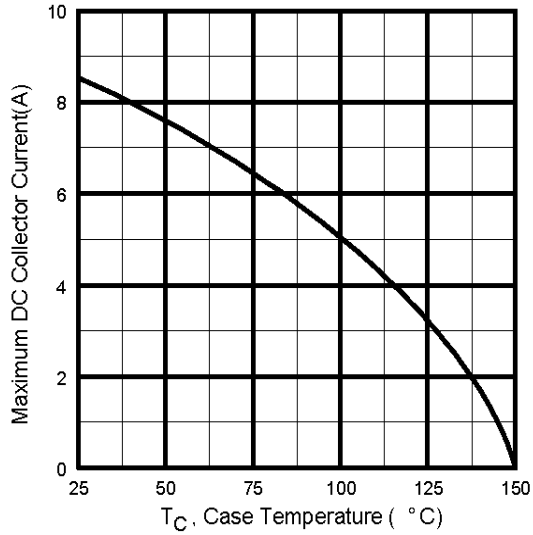
**Fig. 2** - Typical Output Characteristics



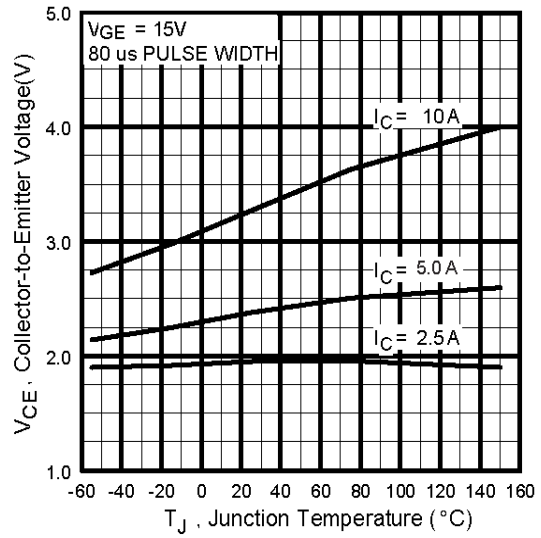
**Fig. 3** - Typical Transfer Characteristics

# IRG4RC10UPbF

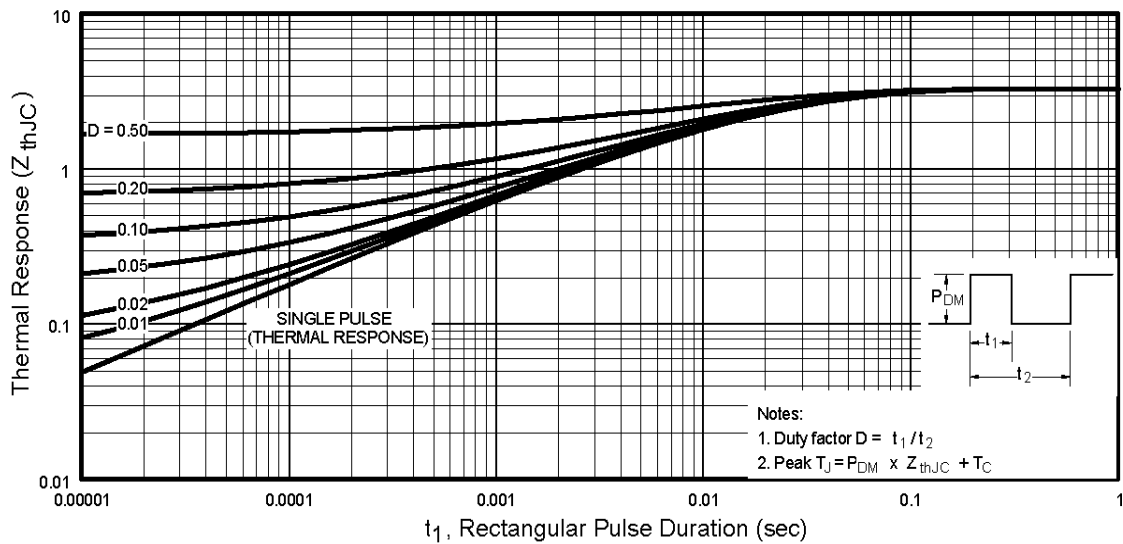
International  
**IR** Rectifier



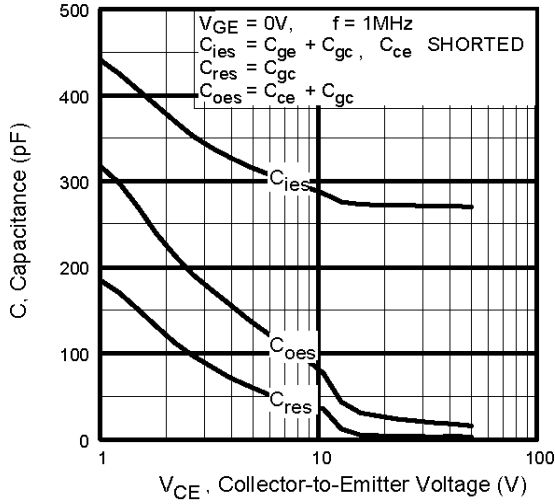
**Fig. 4** - Maximum Collector Current vs. Case Temperature



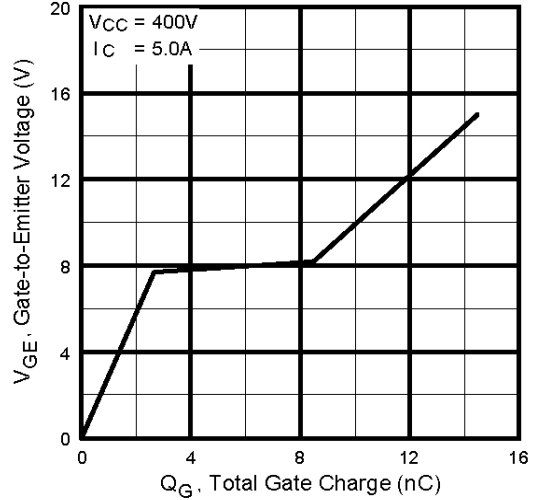
**Fig. 5** - Typical Collector-to-Emitter Voltage vs. Junction Temperature



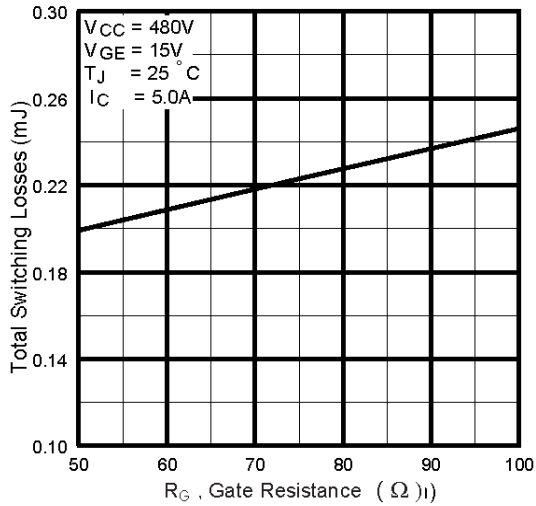
**Fig. 6** - Maximum Effective Transient Thermal Impedance, Junction-to-Case



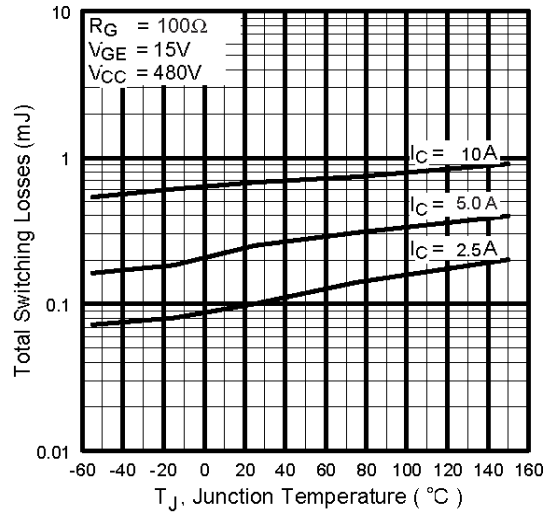
**Fig. 7** - Typical Capacitance vs. Collector-to-Emitter Voltage



**Fig. 8** - Typical Gate Charge vs. Gate-to-Emitter Voltage



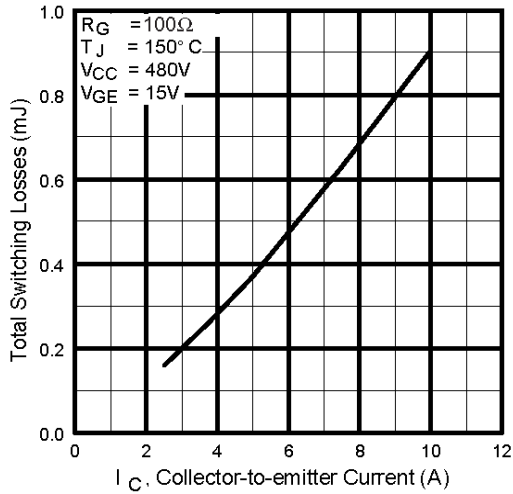
**Fig. 9** - Typical Switching Losses vs. Gate Resistance



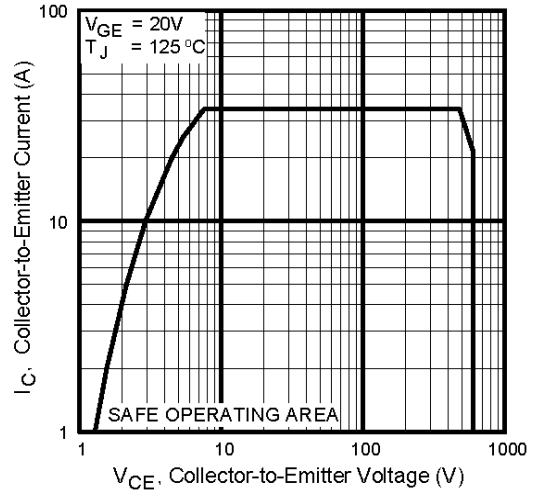
**Fig. 10** - Typical Switching Losses vs. Junction Temperature

# IRG4RC10UPbF

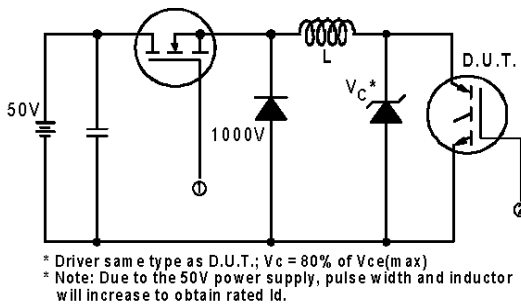
International  
**IR** Rectifier



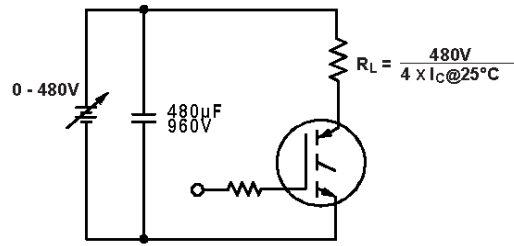
**Fig. 11** - Typical Switching Losses vs. Collector-to-emitter Current



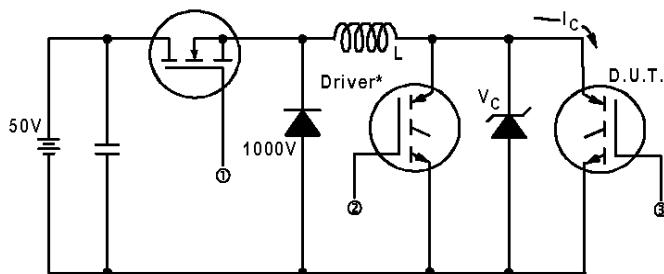
**Fig. 12** - Turn-Off SOA



**Fig. 13a** - Clamped Inductive Load Test Circuit

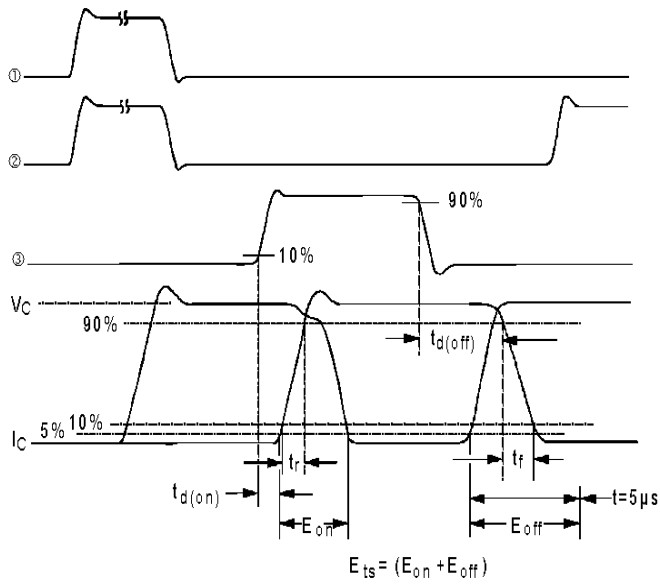


**Fig. 13b** - Pulsed Collector Current Test Circuit



**Fig. 14a** - Switching Loss Test Circuit

\* Driver same type as D.U.T.,  $V_C = 480\text{V}$

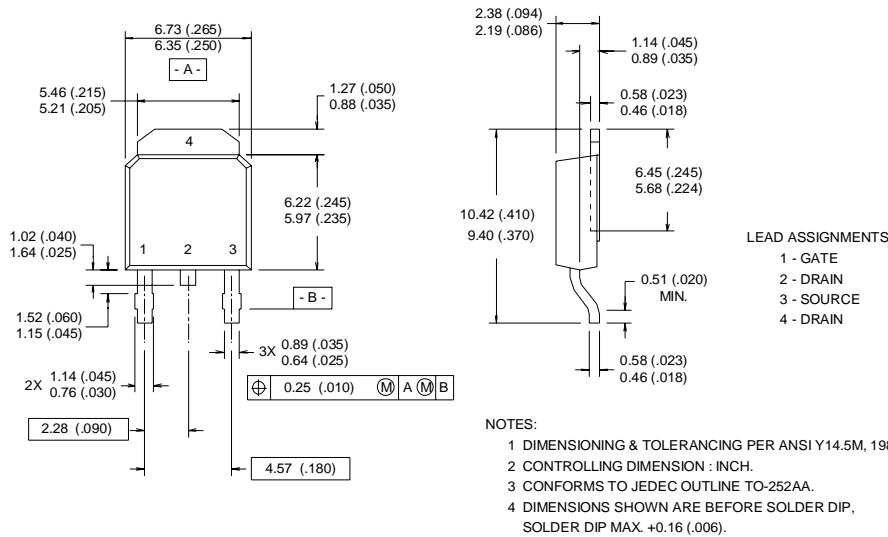


**Fig. 14b** - Switching Loss Waveforms

# IRG4RC10UPbF

## D-Pak (TO-252AA) Package Outline

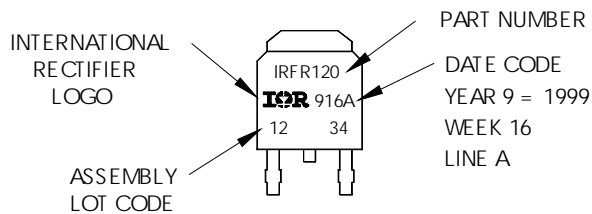
Dimensions are shown in millimeters (inches)



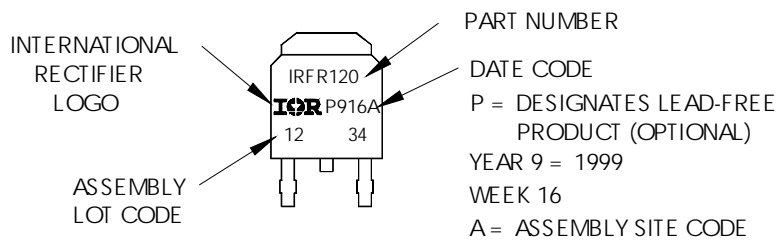
## D-Pak (TO-252AA) Part Marking Information

EXAMPLE: THIS IS AN IRFR120  
WITH ASSEMBLY  
LOT CODE 1234  
ASSEMBLED ON WW 16, 1999  
IN THE ASSEMBLY LINE "A"

Note: "P" in assembly line position indicates "Lead-Free"



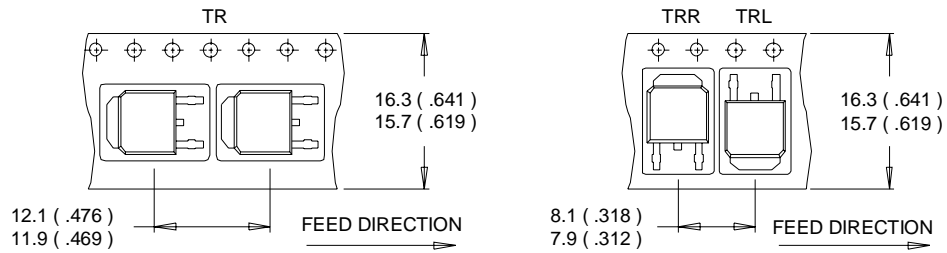
**OR**





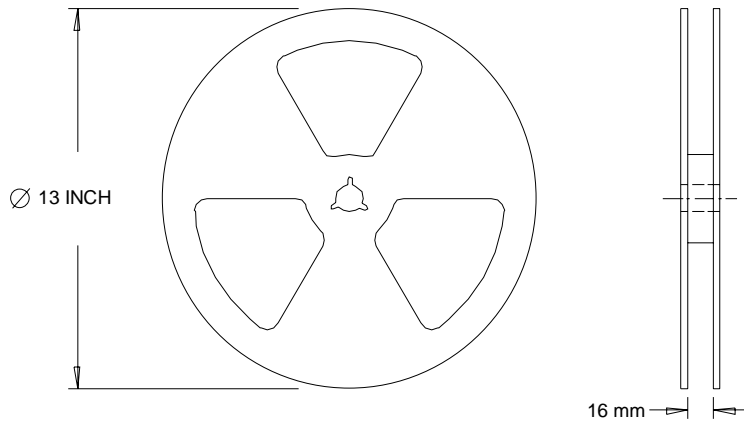
## D-Pak (TO-252AA) Tape & Reel Information

Dimensions are shown in millimeters (inches)



**NOTES :**

1. CONTROLLING DIMENSION : MILLIMETER.
2. ALL DIMENSIONS ARE SHOWN IN MILLIMETERS ( INCHES ).
3. OUTLINE CONFORMS TO EIA-481 & EIA-541.



**NOTES :**

1. OUTLINE CONFORMS TO EIA-481.

Data and specifications subject to change without notice.

Note: For the most current drawings please refer to the IR website at:  
<http://www.irf.com/package/>

# Mouser Electronics

Authorized Distributor

Click to View Pricing, Inventory, Delivery & Lifecycle Information:

[International Rectifier:](#)

[IRG4RC10UTRPBF](#)