

Silicon Switching Diode

- For high-speed switching applications
- Series pair configuration
- BAV99S / U: For orientation in reel see package information below
- Pb-free (RoHS compliant) package¹⁾
- Qualified according AEC Q101

BAV99
BAV99W

BAV99S
BAV99U

Type	Package	Configuration	Marking
BAV99	SOT23	series	A7s
BAV99S	SOT363	dual series	A7s
BAV99U	SC74	dual series	A7s
BAV99W	SOT323	series	A7s

¹Pb-containing package may be available upon special request

Maximum Ratings at $T_A = 25^\circ\text{C}$, unless otherwise specified

Parameter	Symbol	Value	Unit
Diode reverse voltage	V_R	80	V
Peak reverse voltage	V_{RM}	85	
Forward current	I_F	200	mA
Non-repetitive peak surge forward current	I_{FSM}		A
$t = 1 \mu\text{s}$		4.5	
$t = 1 \text{ms}$		1	
$t = 1 \text{s, single}$		0.5	
$t = 1 \text{s, double}$		0.75	
Total power dissipation	P_{tot}		mW
BAV99, $T_S \leq 28^\circ\text{C}$		330	
BAV99S, $T_S \leq 85^\circ\text{C}$		250	
BAV99U, $T_S \leq 113^\circ\text{C}$		250	
BAV99W, $T_S \leq 110^\circ\text{C}$		250	
Junction temperature	T_j	150	$^\circ\text{C}$
Storage temperature	T_{stg}	-65 ... 150	

Thermal Resistance

Parameter	Symbol	Value	Unit
Junction - soldering point ¹⁾	R_{thJS}		K/W
BAV99		≤ 360	
BAV99S		≤ 260	
BAV99U		≤ 150	
BAV99W		≤ 160	

¹⁾For calculation of R_{thJA} please refer to Application Note Thermal Resistance

Electrical Characteristics at $T_A = 25^\circ\text{C}$, unless otherwise specified

Parameter	Symbol	Values			Unit
		min.	typ.	max.	
DC Characteristics					
Breakdown voltage $I_{(BR)} = 100 \mu\text{A}$	$V_{(BR)}$	85	-	-	V
Reverse current $V_R = 70 \text{ V}$ $V_R = 25 \text{ V}, T_A = 150^\circ\text{C}$ $V_R = 70 \text{ V}, T_A = 150^\circ\text{C}$	I_R	-	-	0.15 30 50	μA
Forward voltage $I_F = 1 \text{ mA}$ $I_F = 10 \text{ mA}$ $I_F = 50 \text{ mA}$ $I_F = 100 \text{ mA}$ $I_F = 150 \text{ mA}$	V_F	-	-	715 855 1000 1200 1250	mV

Electrical Characteristics at $T_A = 25^\circ\text{C}$, unless otherwise specified

Parameter	Symbol	Values			Unit
		min.	typ.	max.	
AC Characteristics					
Diode capacitance $V_R = 0 \text{ V}, f = 1 \text{ MHz}$	C_T	-	-	1.5	pF
Reverse recovery time $I_F = 10 \text{ mA}, I_R = 10 \text{ mA}$, measured at $I_R = 1 \text{ mA}$, $R_L = 100 \Omega$	t_{rr}	-	-	4	ns

Test circuit for reverse recovery time

Pulse generator: $t_p = 100\text{ns}$, $D = 0.05$,
 $t_r = 0.6\text{ns}$, $R_i = 50\Omega$

Oscilloscope: $R = 50$, $t_r = 0.35\text{ns}$
 $C \leq 1\text{pF}$

Reverse current $I_R = f(T_A)$

$V_R = \text{Parameter}$

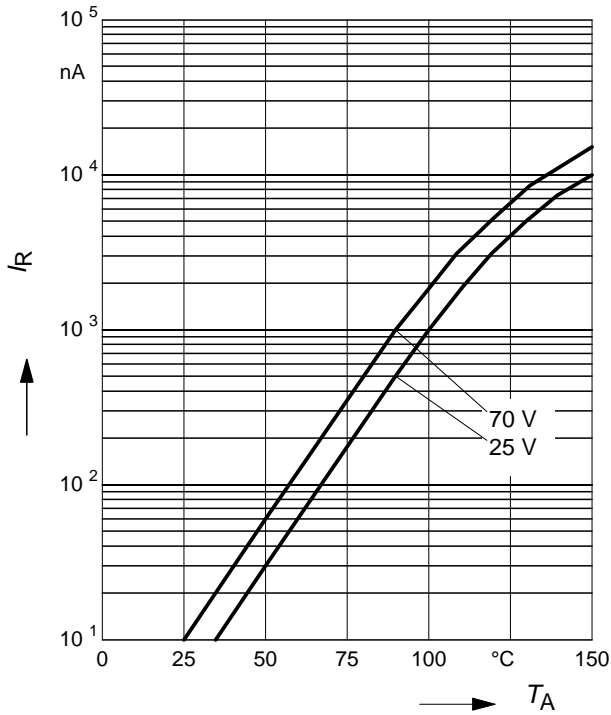

Forward Voltage $V_F = f(T_A)$

$I_F = \text{Parameter}$



Forward current $I_F = f(V_F)$

$T_A = 25^\circ\text{C}$



Forward current $I_F = f(T_S)$

BAV99

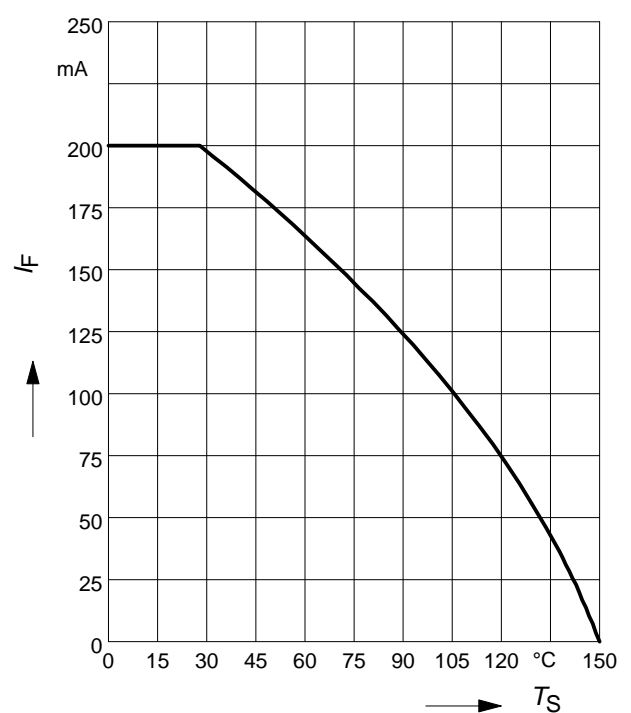

Forward current $I_F = f(T_S)$

BAV99S

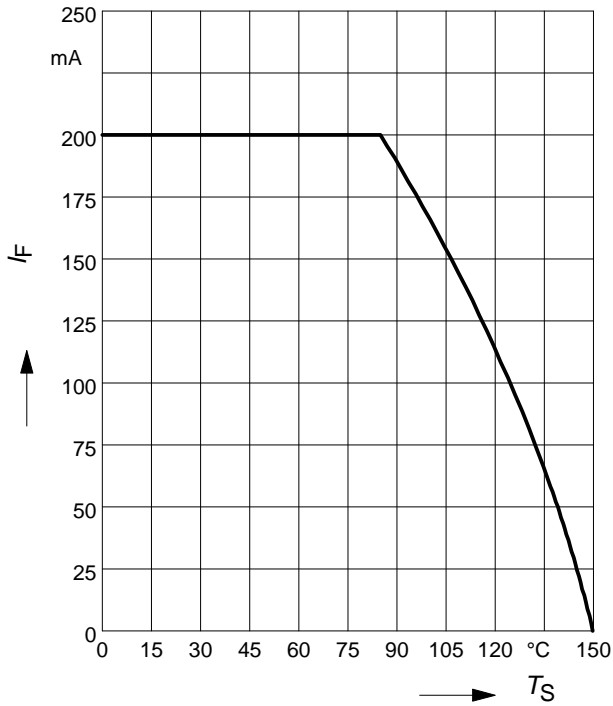

Forward current $I_F = f(T_S)$

BAV99U

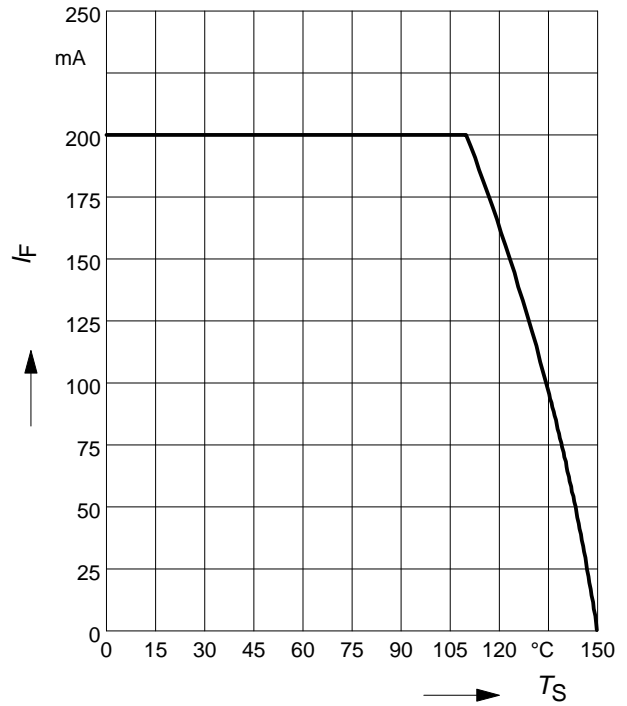

Forward current $I_F = f(T_S)$

BAV99W

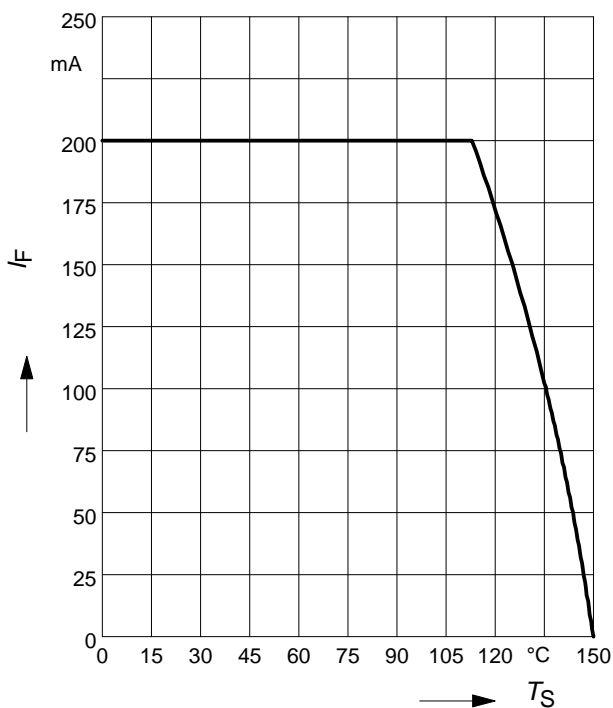

Permissible Puls Load $R_{thJS} = f(t_p)$

BAV99



Permissible Pulse Load

$I_{Fmax} / I_{FDC} = f(t_p)$

BAV99

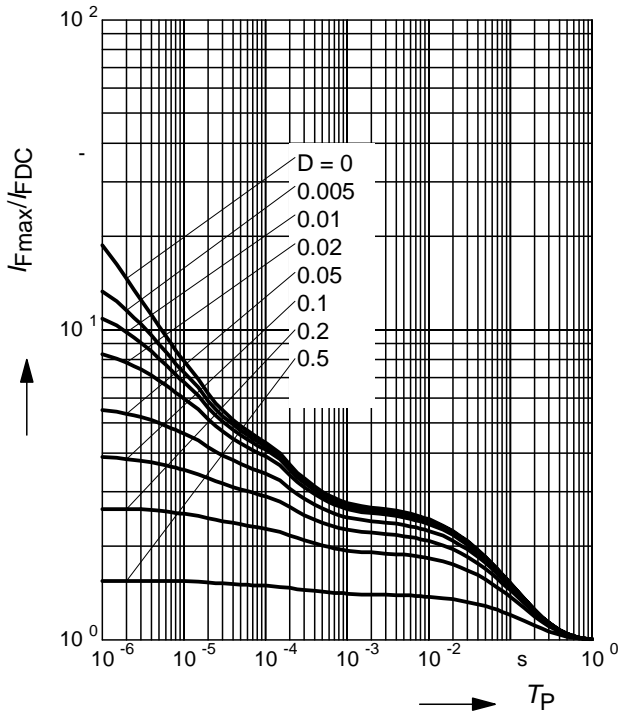

Permissible Puls Load $R_{thJS} = f(t_p)$

BAV99S

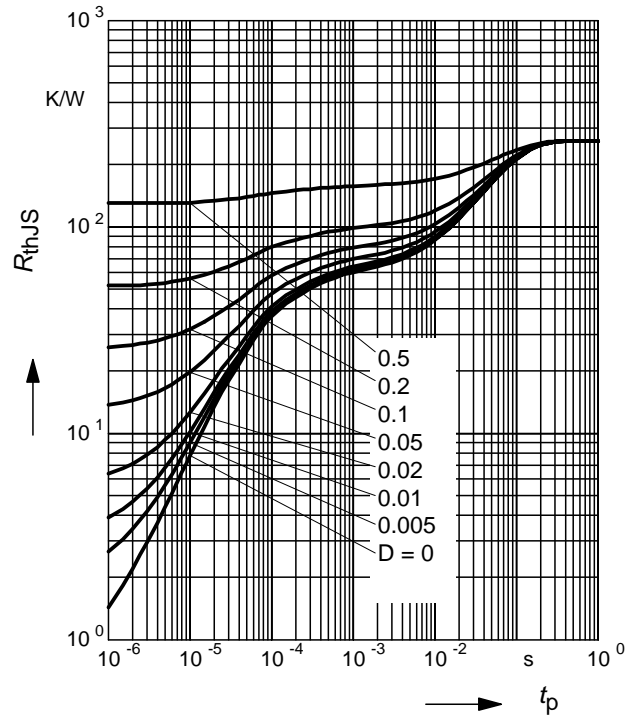

Permissible Pulse Load

$I_{Fmax} / I_{FDC} = f(t_p)$

BAV99S

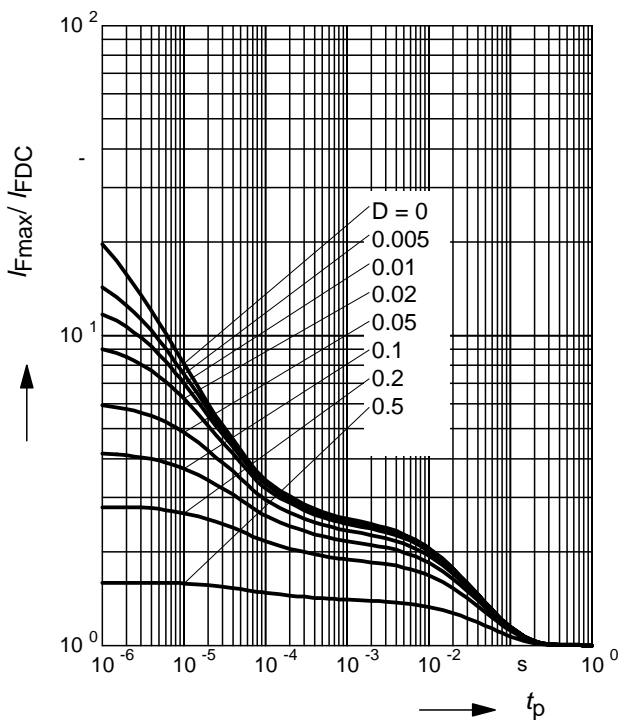

Permissible Puls Load $R_{thJS} = f(t_p)$

BAV99U



Permissible Pulse Load

$$I_{Fmax} / I_{FDC} = f(t_p)$$

BAV99U

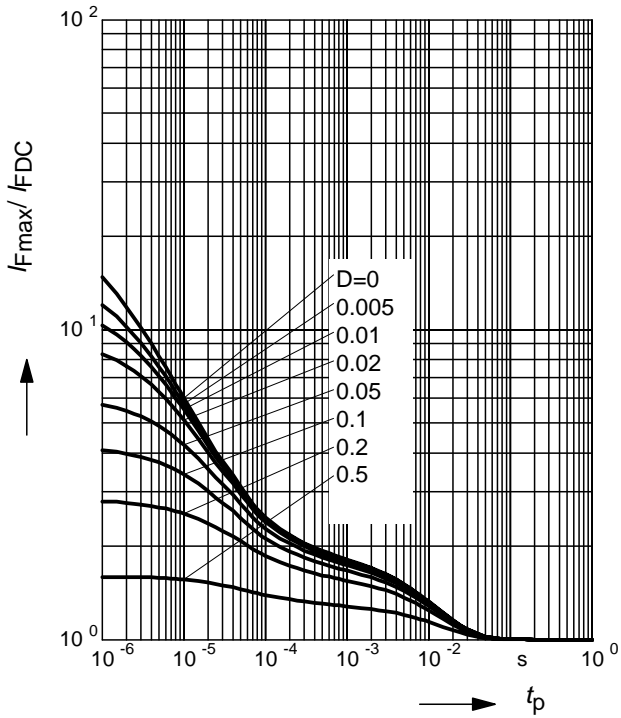

Permissible Puls Load $R_{thJS} = f(t_p)$

BAV99W

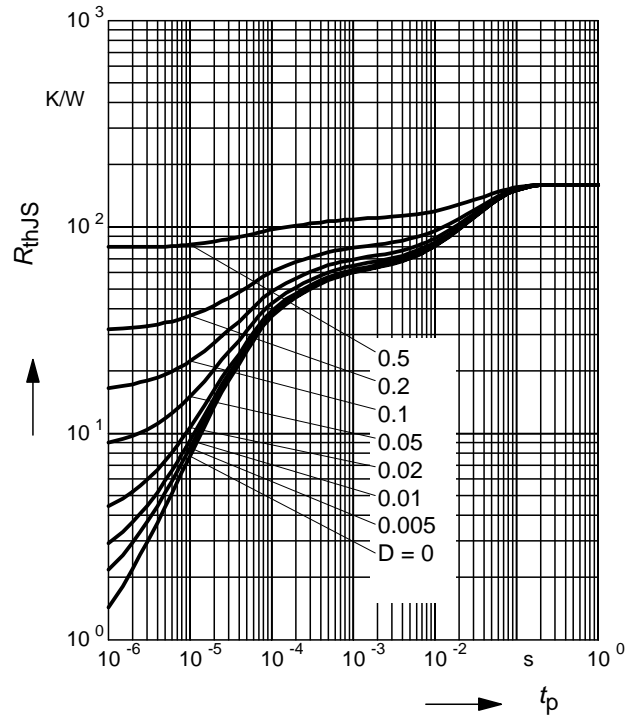

Permissible Pulse Load

$$I_{Fmax} / I_{FDC} = f(t_p)$$

BAV99W

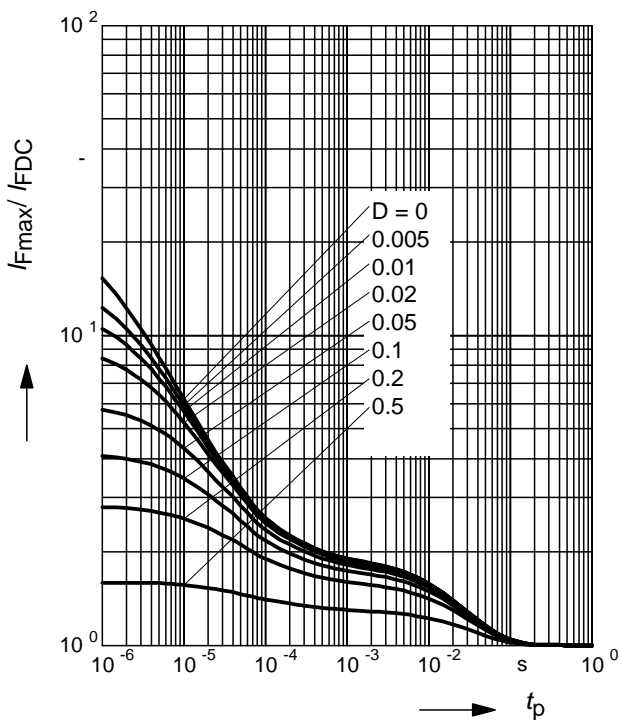

Package Outline



Foot Print



Marking Layout (Example)

Small variations in positioning of Date code, Type code and Manufacture are possible.



Standard Packing

Reel \varnothing 180 mm = 3.000 Pieces/Reel
 Reel \varnothing 330 mm = 10.000 Pieces/Reel

For symmetric types no defined Pin 1 orientation in reel.



Package Outline



1) Lead width can be 0.6 max. in dambar area

Foot Print



Marking Layout (Example)



Standard Packing

Reel \varnothing 180 mm = 3.000 Pieces/Reel
 Reel \varnothing 330 mm = 10.000 Pieces/Reel



Package Outline



Foot Print



Marking Layout (Example)



Standard Packing

Reel $\varnothing 180$ mm = 3.000 Pieces/Reel
 Reel $\varnothing 330$ mm = 10.000 Pieces/Reel



Package Outline

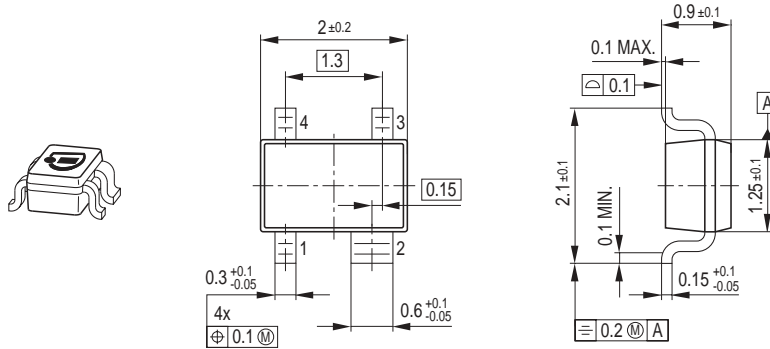

Foot Print



Marking Layout (Example)

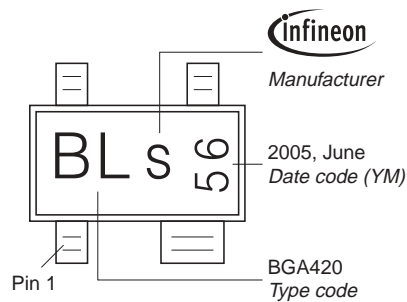

Standard Packing

Reel ø180 mm = 3.000 Pieces/Reel
 Reel ø330 mm = 10.000 Pieces/Reel



Package Outline

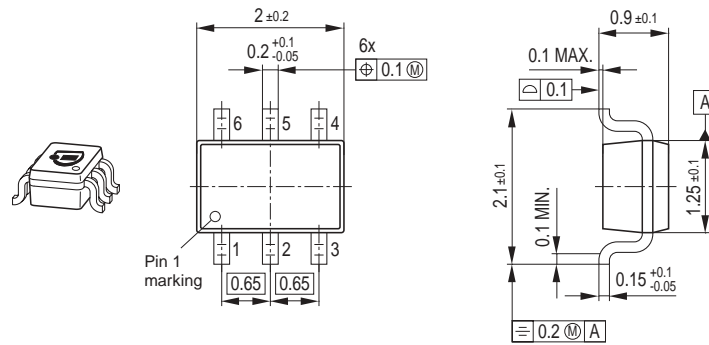

Foot Print

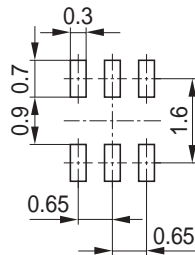

Marking Layout (Example)

Small variations in positioning of Date code, Type code and Manufacture are possible.

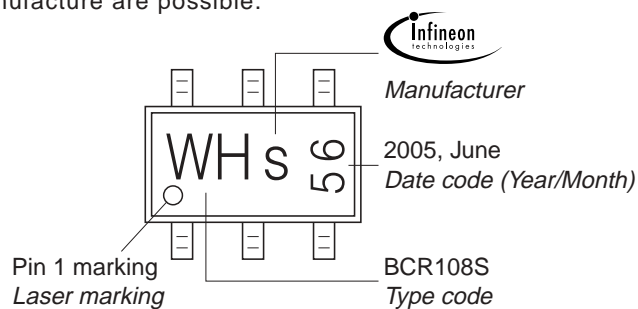

Standard Packing

Reel \varnothing 180 mm = 3.000 Pieces/Reel
 Reel \varnothing 330 mm = 10.000 Pieces/Reel

For symmetric types no defined Pin 1 orientation in reel.

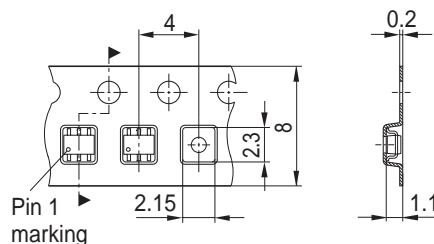

Edition 2006-02-01

Published by

Infineon Technologies AG

81726 München, Germany

© Infineon Technologies AG 2007.

All Rights Reserved.

Attention please!

The information given in this dokument shall in no event be regarded as a guarantee of conditions or characteristics ("Beschaffenheitsgarantie"). With respect to any examples or hints given herein, any typical values stated herein and/or any information regarding the application of the device, Infineon Technologies hereby disclaims any and all warranties and liabilities of any kind, including without limitation warranties of non-infringement of intellectual property rights of any third party.

Information

For further information on technology, delivery terms and conditions and prices please contact your nearest Infineon Technologies Office (www.infineon.com).

Warnings

Due to technical requirements components may contain dangerous substances. For information on the types in question please contact your nearest Infineon Technologies Office.

Infineon Technologies Components may only be used in life-support devices or systems with the express written approval of Infineon Technologies, if a failure of such components can reasonably be expected to cause the failure of that life-support device or system, or to affect the safety or effectiveness of that device or system.

Life support devices or systems are intended to be implanted in the human body, or to support and/or maintain and sustain and/or protect human life. If they fail, it is reasonable to assume that the health of the user or other persons may be endangered.

Mouser Electronics

Authorized Distributor

Click to View Pricing, Inventory, Delivery & Lifecycle Information:

[Infineon:](#)

[BAV99UE6327HTSA1](#) [BAV99SH6327XTSA1](#)