

Infineon[®] LITIX[™] Linear

TLD1211SJ

High Side Current Source
1 channel

Typical 85mA load current, up to 2.5A load current using external transistors

Data sheet

Rev. 1.0, 2015-02-19

Automotive



1 Overview

Features

- Adjustable Constant Output Current up to 85 mA
- LED Current of 2.5 A possible by using external Power Transistors
- Voltage Drop across Sense Resistor typ. 0.15 V
- Internal Bandgap Voltage Reference enables High Output Current accuracy
- EN Input for PWM brightness control
- Overvoltage Protection
- Temperature dependent Output Current Reduction
- Very Low Standby Current
- Maximum Operating Voltage 28 V
- Small SMD Package
- Green Product (RoHS compliant)
- AEC Qualified



PG-DSO-8-16

Applications

- LED Controller for Automotive applications, Low- and High-Power LED
- Universal Constant Current Source
- Interior and Exterior Lighting
- Instrument backlighting
- Illumination

Description

The TLD1211SJ is an integrated adjustable constant current source realized in a bipolar IC technology. The IC is designed to supply LEDs under the severe conditions of automotive applications resulting in constant brightness and extended LED lifetime. The TLD1211SJ is capable to drive high current, high brightness LEDs up to 2.5 A by using additional external output stages as “booster” transistors. For LED currents up to 85mA the IC can be used as a stand alone device and requires only one voltage sense resistor as an external component.

Protection circuits prevent damage to the device in case of overload, short circuit, over voltage, and overtemperature.

Furthermore, the temperature dependent current reduction is able to protect LEDs which are thermally coupled to the IC. The integrated EN input of the TLD1211SJ enables LED brightness control by pulse width modulation.

Type	Package	Marking
TLD1211SJ	PG-DSO-8-16	TLD1211SJ

2 Block Diagram

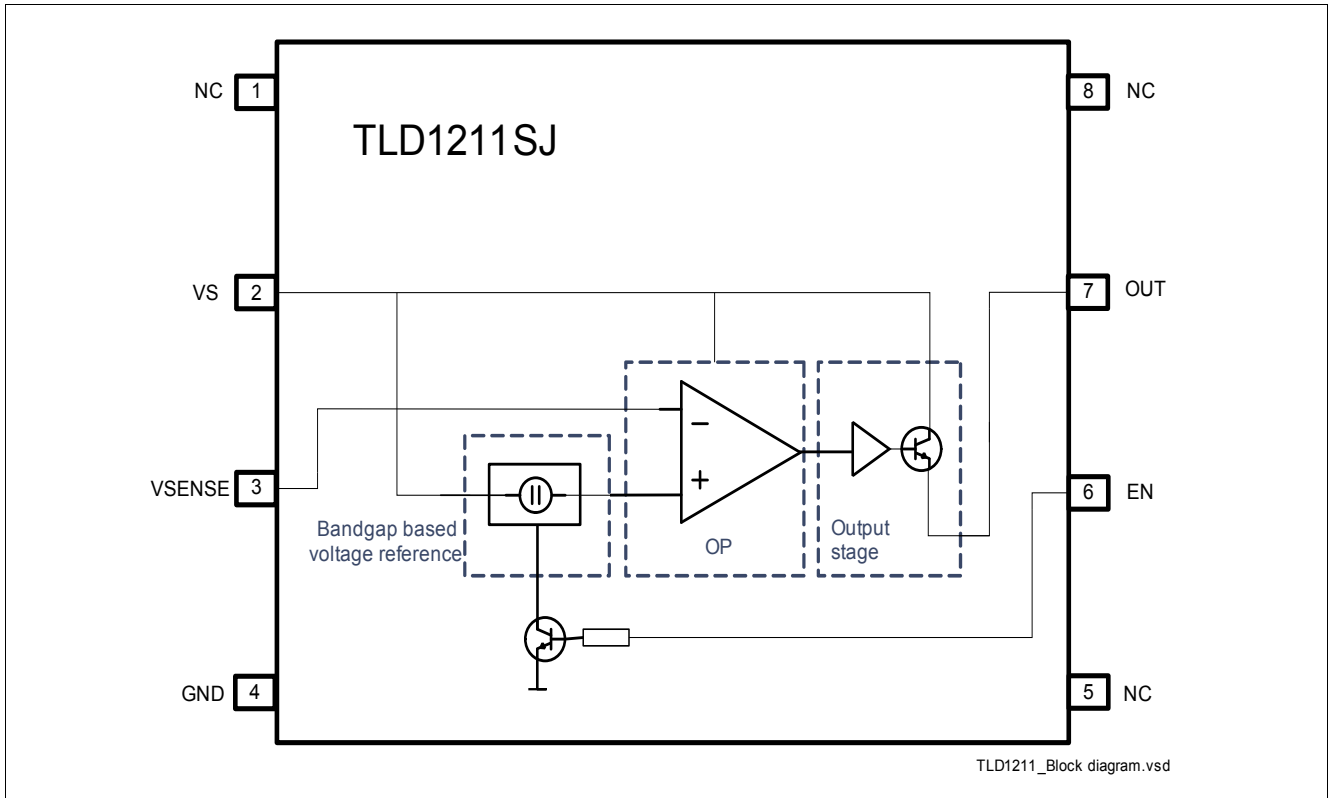

Figure 1 Block Diagram

2.1 Closed Loop Test Setup

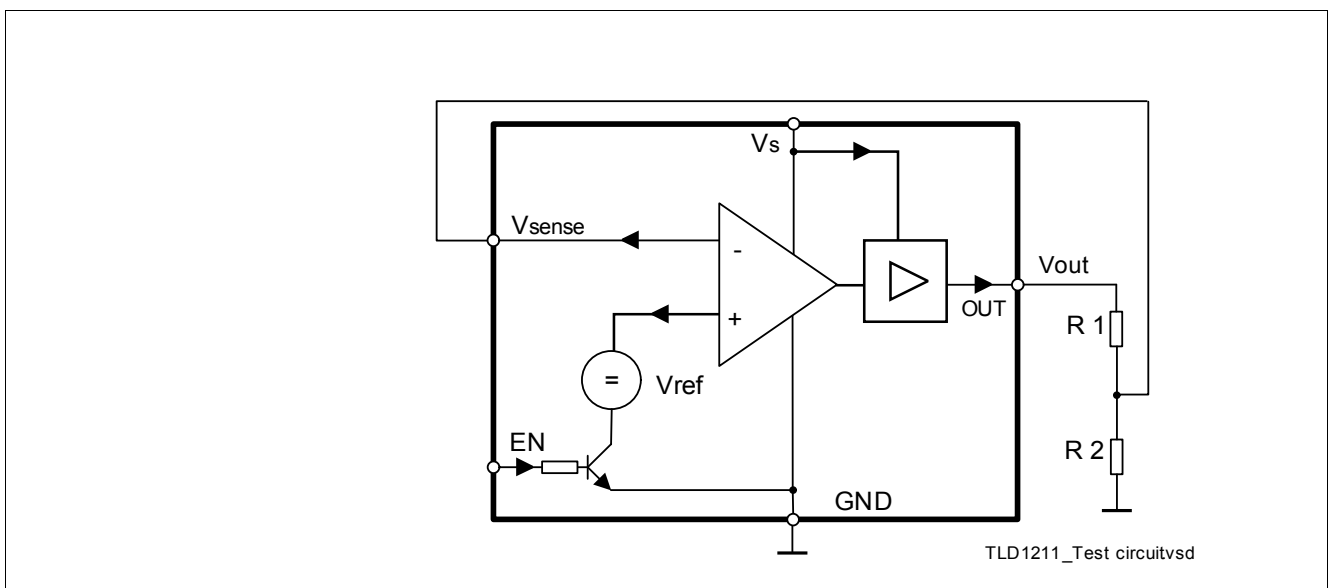

Figure 2 Closed loop Test setup

3 Pin Configuration

3.1 Pin Assignment

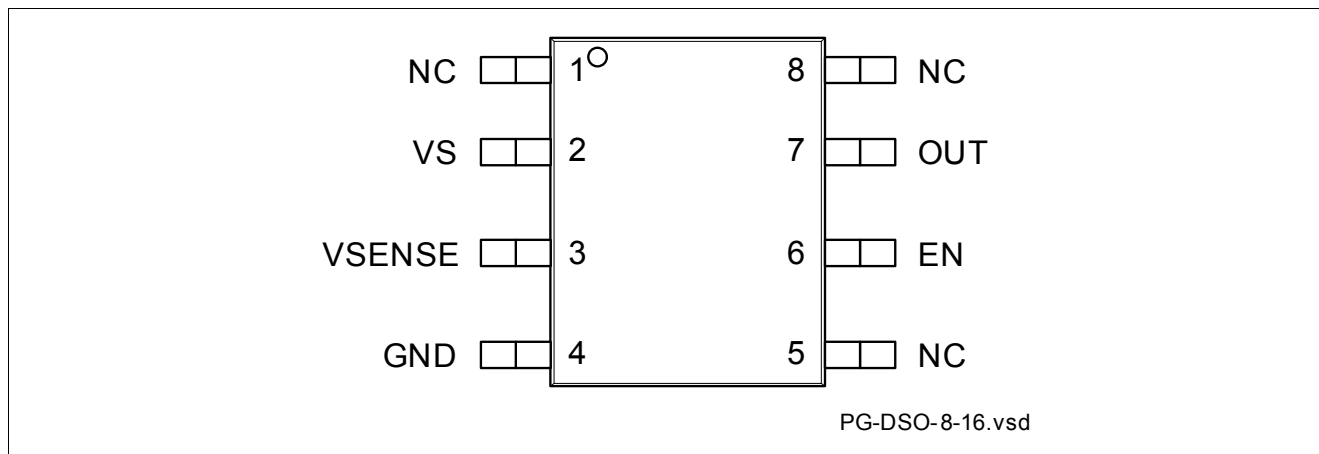

Figure 3 Pin Configuration

3.2 Pin Definition and Functions

Pin	Symbol	Function
1	NC	Not Connected
2	V_s	Supply voltage
3	V_{sense}	Sense input
4	GND	IC ground, connect with pin 2 on PCB
5	NC	Not Connected
6	EN	Enable (<i>PWM input</i>)
7	OUT	Output
8	NC	Not Connected

4 Electrical Characteristics

4.1 Absolute Maximum Ratings

Table 1 Absolute Maximum Ratings¹⁾

40 °C < T_J < 150 °C; all voltages with respect to ground; positive current defined flowing into pin; unless otherwise specified

Pos.	Parameter	Symbol	Limit values		Unit	Remark
			Min.	Max.		
4.1.1	Supply voltage	V_s	-0.3	45	V	
4.1.2	Sense Voltage	V_{sense}	-0.3	7	V	
4.1.3	EN Voltage	V_{EN}	-0.3	7	V	
4.1.4	Output current	I_{out}	–	–	mA	internally limited
4.1.5	Power Dissipation	P_{tot}	0	500	mW	
4.1.6	Junction temperature	T_J	-40	150	°C	
4.1.7	Storage temperature range	T_{STG}	-55	150	°C	
4.1.8	ESD resistivity	V_{ESD_HBM}	-4000	4000	V	HBM ²⁾

1) Not subject to production test, specified by design

2) ESD susceptibility HBM according to EIA/JESD 22-A 114B

4.2 Thermal Resistance

Table 2 Thermal Resistance

Pos.	Parameter	Symbol	Limit Values			Unit	Conditions
			Min.	Typ.	Max.		
4.2.1	Junction to Ambient ^{1) 2)}	R_{thJA}	–	155	–	K/W	Footprint only
			–	96	–	K/W	300 mm ² PCB heatsink area
			–	86	–	K/W	600 mm ² PCB heatsink area

1) Not subject to production test, specified by design

2) Package was simulated on a FR4 PCB, 80 x 80 x 1.5 mm; 35 µm Cu

4.3 Electrical Characteristics

Table 3 Electrical Characteristics
 $8\text{ V} < V_S < 28\text{ V}$; $-40\text{ °C} < T_J < 150\text{ °C}$, $EN = 5\text{ V}$; $R_1, R_2 = \text{open}$; all voltages with respect to ground;
 positive current defined flowing into pin; unless otherwise specified

Pos.	Parameter	Symbol	Values			Unit	Note / Test Condition
			Min.	Typ.	Max.		
4.3.1	Operating current during over voltage	$I_{S_{OV}}$	–	–	600	μA	$V_{out} = 0\text{ V}$; $V_S = 42\text{ V}$; $V_{sense} = 0\text{ mV}$
4.3.2	Operating current during open load	$I_{S_{open\ load}}$	0.5	1.4	1.7	mA	$V_{out} = \text{open}$; $V_{sense} = 0\text{ mV}$
4.3.3	Standby current	$I_{S_{standby}}$	–	–	300	nA	$EN = 0\text{ V}$; $V_{sense} = 0\text{ mV}$; $T_J < 85\text{ °C}^{(1)}$
4.3.4	Standby current	$I_{S_{standby,HOT}}$	–	–	30	μA	$EN = 0\text{ V}$; $V_{sense} = 0\text{ mV}$
4.3.51	Output current	$I_{out,ONCOLD}$	40	–	–	mA	$V_S - V_{out} = 3\text{ V}$; $V_{sense} = 0\text{ mV}$; $T_J = -40\text{ °C}$
4.3.52	Output current	$I_{out,ON}$	65	85	110	mA	$V_S - V_{out} = 3\text{ V}$; $V_{sense} = 0\text{ mV}$; $T_J > 0\text{ °C}^{(1)}$; $T_J < 135\text{ °C}^{(1)}$
4.3.6	Output current	$I_{out,ONHOT}$	60	–	–	mA	$V_S - V_{out} = 3\text{ V}$; $V_{sense} = 0\text{ mV}$; $T_J = 150\text{ °C}$
4.3.7	Output Leakage current	$I_{out,OFF}$	–	–	400	nA	$EN = 0\text{ V}$; $V_{out} = 0\text{ V}$
4.3.8	Current of Sense input	I_{sense}	-5	–	0.5	μA	$V_{out} = 0\text{ V}$; $V_{sense} = 200\text{ mV}$
4.3.9	Voltage of Sense input	V_{sense}	135	150	165	mV	$R_1 = 390\text{ }Ω$; $R_2 = 10\text{ }Ω$ See Figure 2 ; $T_J < 115\text{ °C}^{(1)}$
4.3.10	Over voltage Protection	$V_{s,OV}$	28	33	–	V	–
4.3.11	Drop Voltage	$V_S - V_{out}$	–	–	1.3	V	$I_{out} < 15\text{ mA}$ $V_{sense} = 0\text{ mV}$; $V_S = 8\text{ V}$

EN Input

4.3.12	Current of enable input	I_{EN}	60	90	130	μA	$V_{EN} = 5\text{ V}$
4.3.13	High Level voltage range	$V_{EN,ON}$	1	–	5.5	V	Use resistors at pin to be CMOS/TTL compatible; See Figure 16
4.3.14	Low Level voltage range	$V_{EN,OFF}$	-0.3	–	0.3	V	Use resistors at pin to be CMOS/TTL compatible; See Figure 16

Table 3 Electrical Characteristics (cont'd)

$8\text{ V} < V_S < 28\text{ V}$; $-40\text{ }^\circ\text{C} < T_J < 150\text{ }^\circ\text{C}$, $EN = 5\text{ V}$; $R_1, R_2 = \text{open}$; all voltages with respect to ground; positive current defined flowing into pin; unless otherwise specified

Pos.	Parameter	Symbol	Values			Unit	Note / Test Condition
			Min.	Typ.	Max.		
4.3.15	Turn on time ²⁾	$t_{EN,ON}$	–	–	65	μs	$I_{out100\%} = 15\text{mA}$, See Figure 4 ; $R_1 = 390\ \Omega$; $R_2 = 10\ \Omega$, See Figure 2
4.3.16	Turn off time ²⁾	$t_{EN,OFF}$	–	–	60	μs	$I_{out100\%} = 15\text{mA}$; See Figure 4 ; $R_1 = 390\ \Omega$; $R_2 = 10\ \Omega$, See Figure 2

1) Not subject to production test, based on temperature characterization

2) When using an external Boost transistor this time is reduced (See also [Figure 16](#))

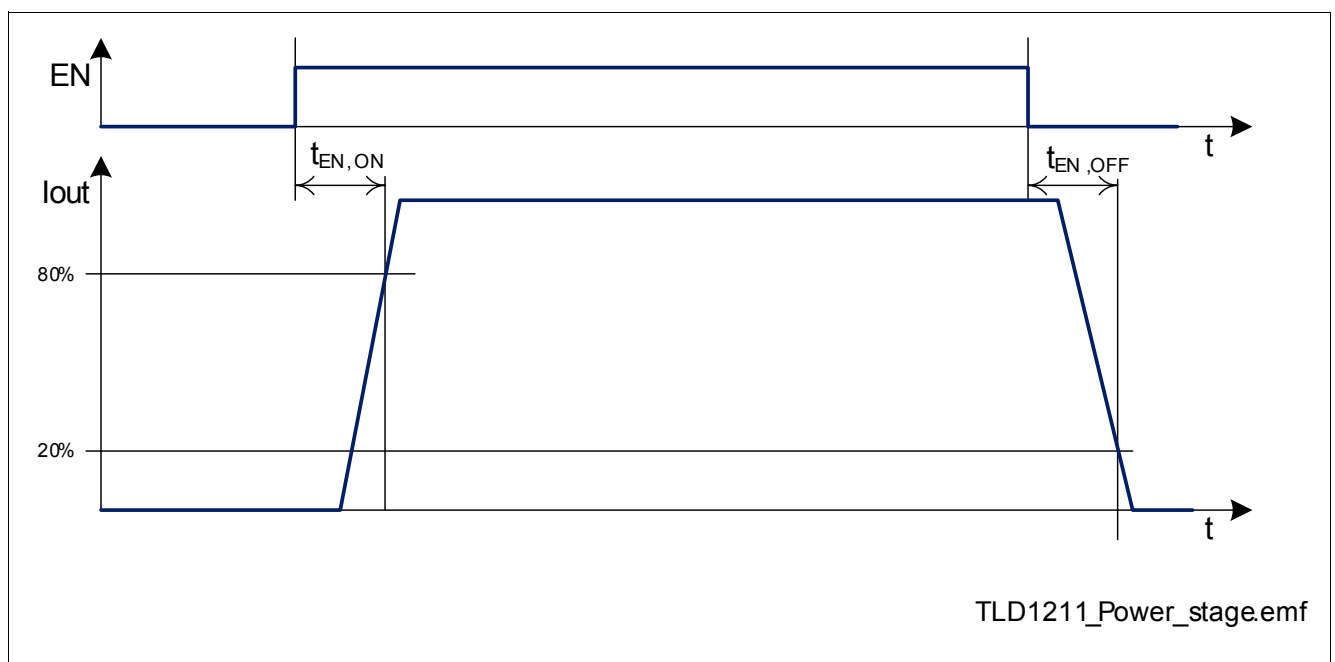

TLD1211_Power_stage.emf

Figure 4 Timing Diagram

5 Characterization Data

Characterization data based on typical device. TLD1211SJ has been measured in a setup with undefined high thermal resistance.

5.1 Setup 1

Setup according to [Figure 2](#). $R_1 = 390 \Omega$, $R_2 = 10 \Omega$, $V_{EN} = 5 V$

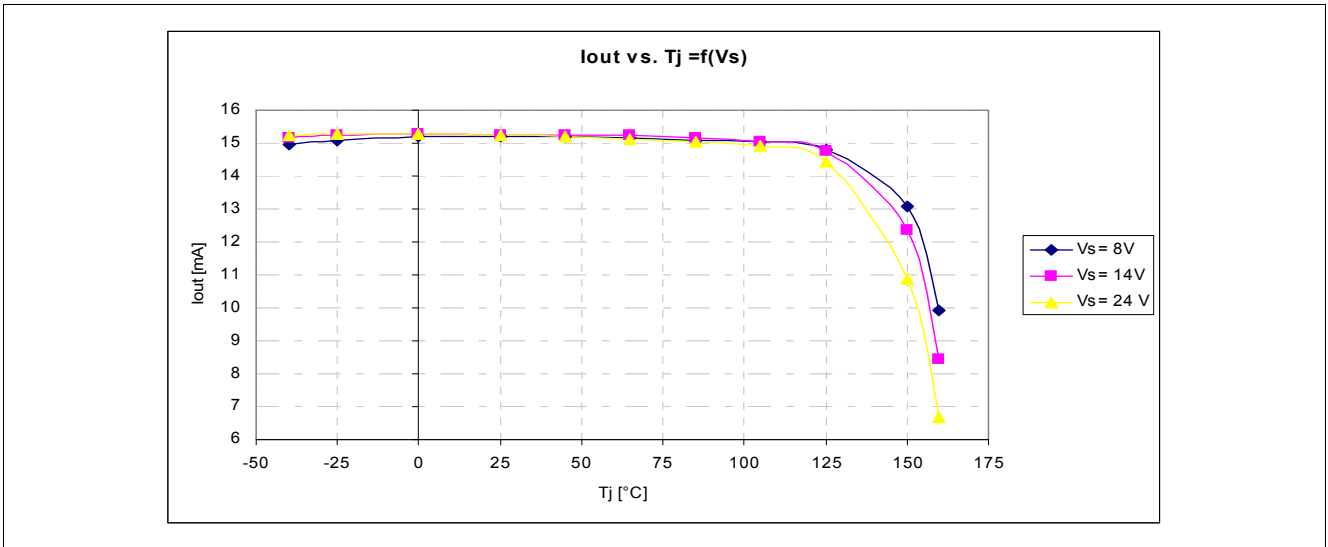

Figure 5 I_{out} vs $T_J = f(V_s)$

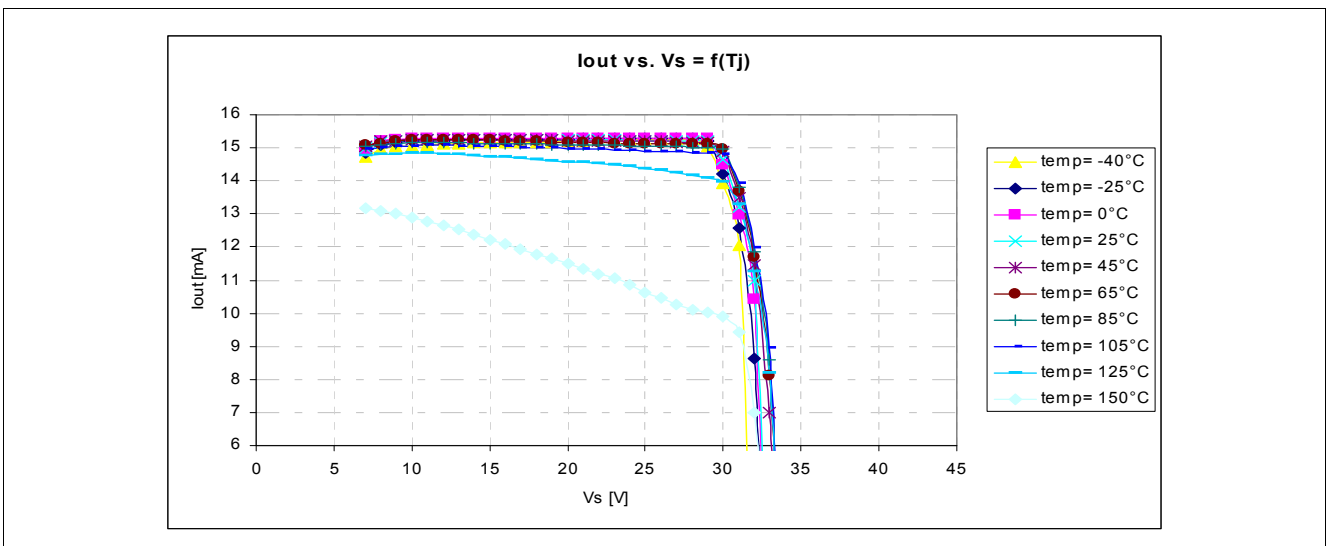

Figure 6 I_{out} vs $V_s = f(T_J)$

5.2 Setup 2

Setup according to **Figure 2**. $R_1 = 0 \Omega$, $R_2 = 0 \Omega$, $V_{out} = 0 V$, $V_{sense} = 0 V$, $V_{EN} = 5 V$

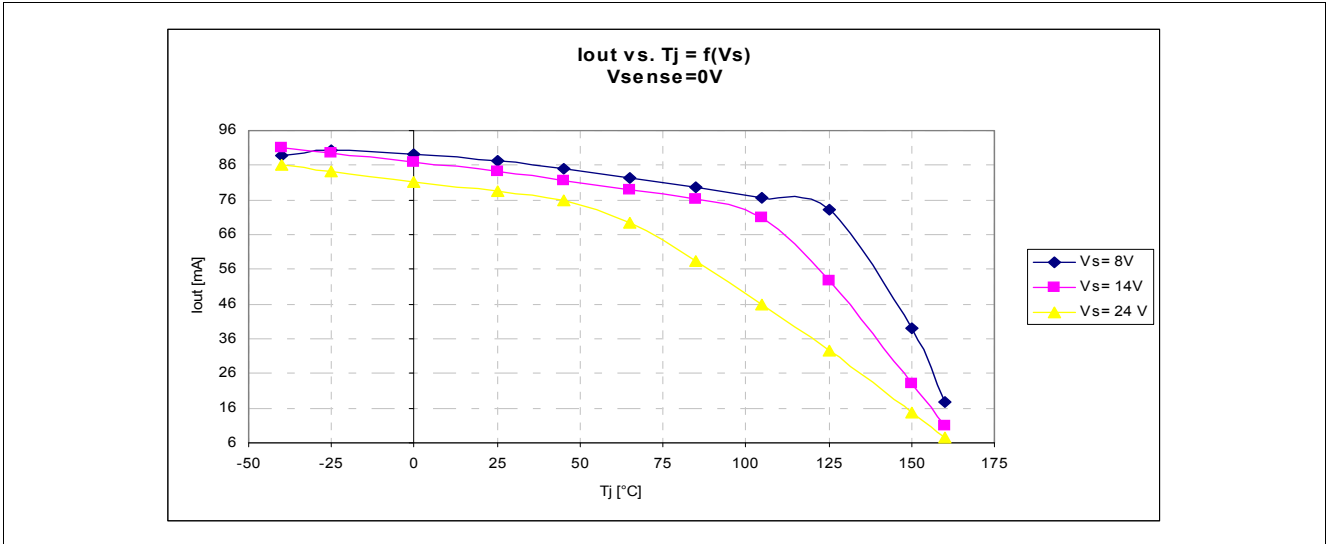

Figure 7 I_{out} vs $T_J = f(V_s)$

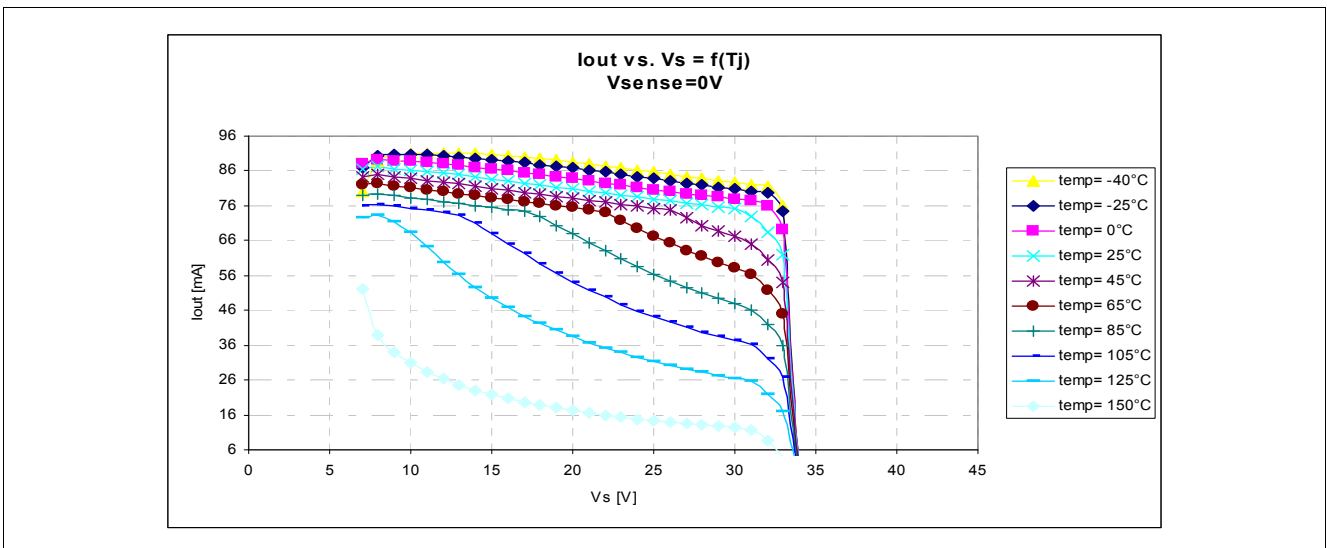

Figure 8 I_{out} vs $V_s = f(T_J)$

5.3 Setup 3

$V_{out} = 0\text{ V}$, V_{sense} = variable, $V_{EN} = 5\text{ V}$

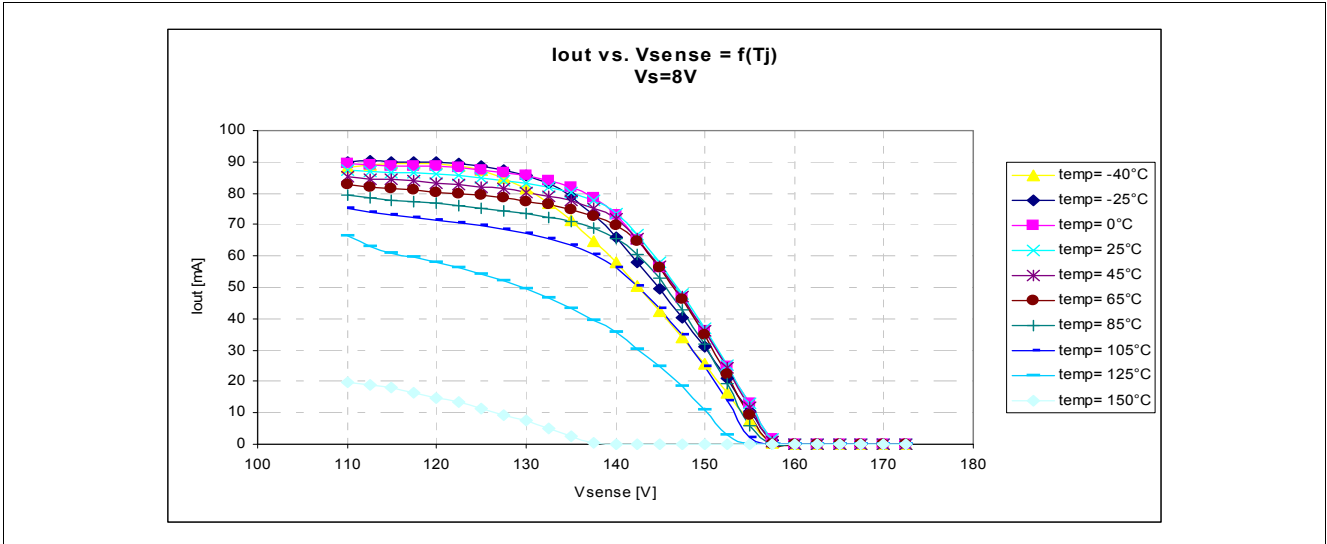

Figure 9 I_{out} vs $V_{sense} = f(T_j)$ at $V_s = 8\text{ V}$

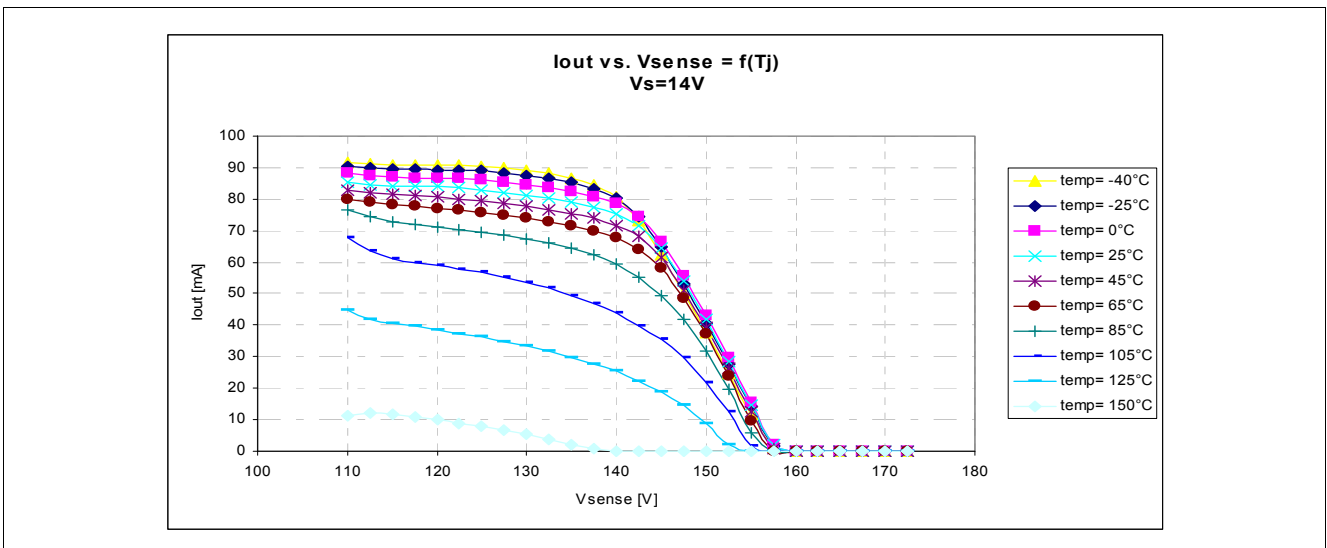

Figure 10 I_{out} vs $V_{sense} = f(T_j)$ at $V_s = 14\text{ V}$

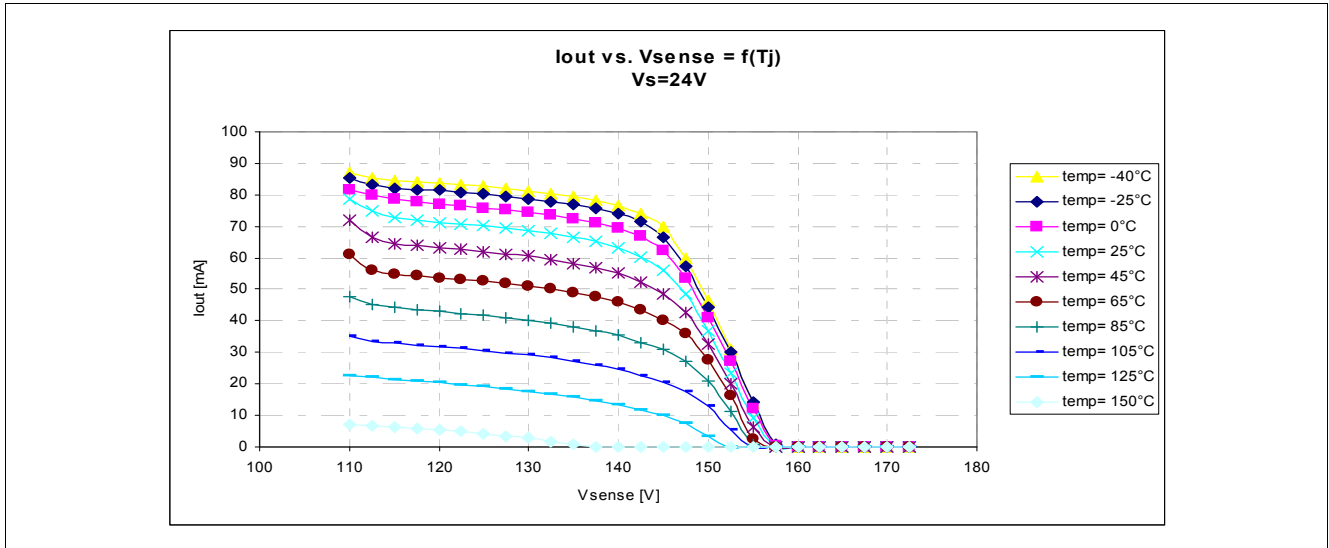

Figure 11 I_{out} vs $V_{sense} = f(T_J)$ at $V_s = 24$ V

5.4 Setup 4

$V_s = 14$ V, $V_{out} = 6$ V, $V_{sense} = 20$ mV, $V_{EN} =$ variable

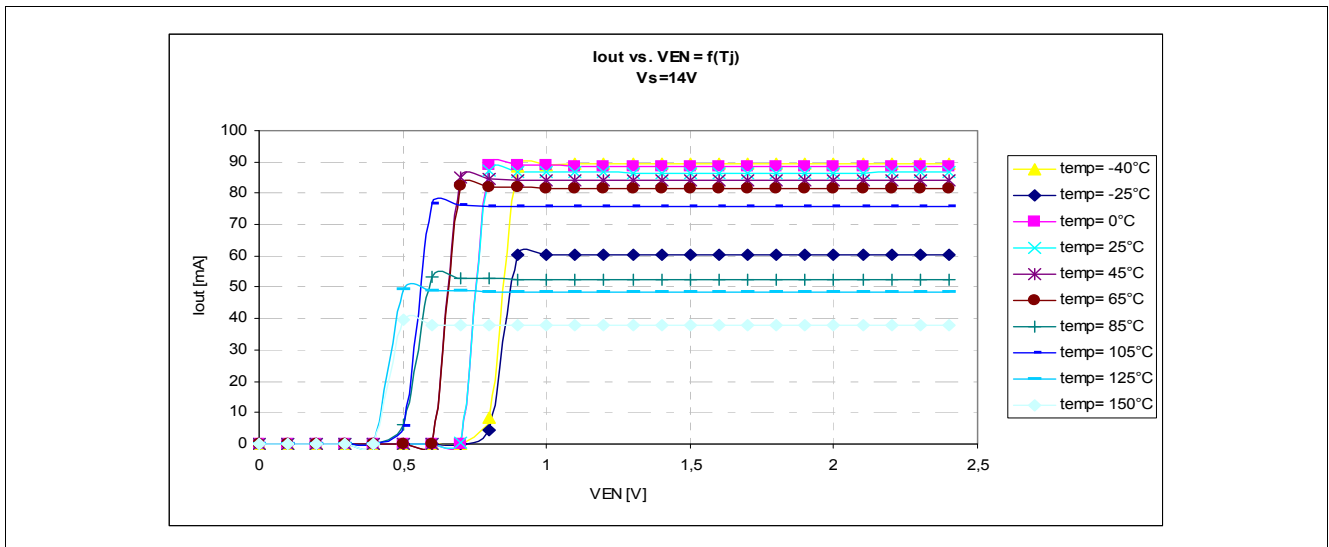

Figure 12 I_{out} vs $V_{EBN} = f(T_J)$ at $V_s = 14$ V

5.5 Setup 5

$V_{out} = 0\text{ V}$, $V_{sense} = 0\text{ V}$, $V_{EN} = 0\text{ V}$

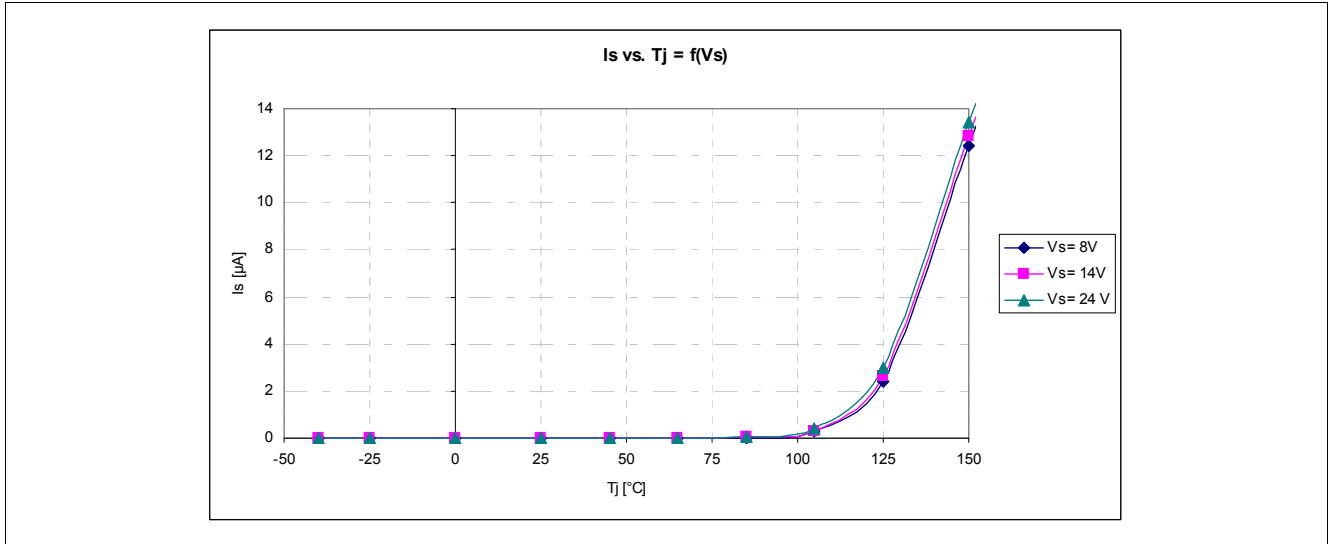

Figure 13 I_s vs $T_J = f(V_s)$

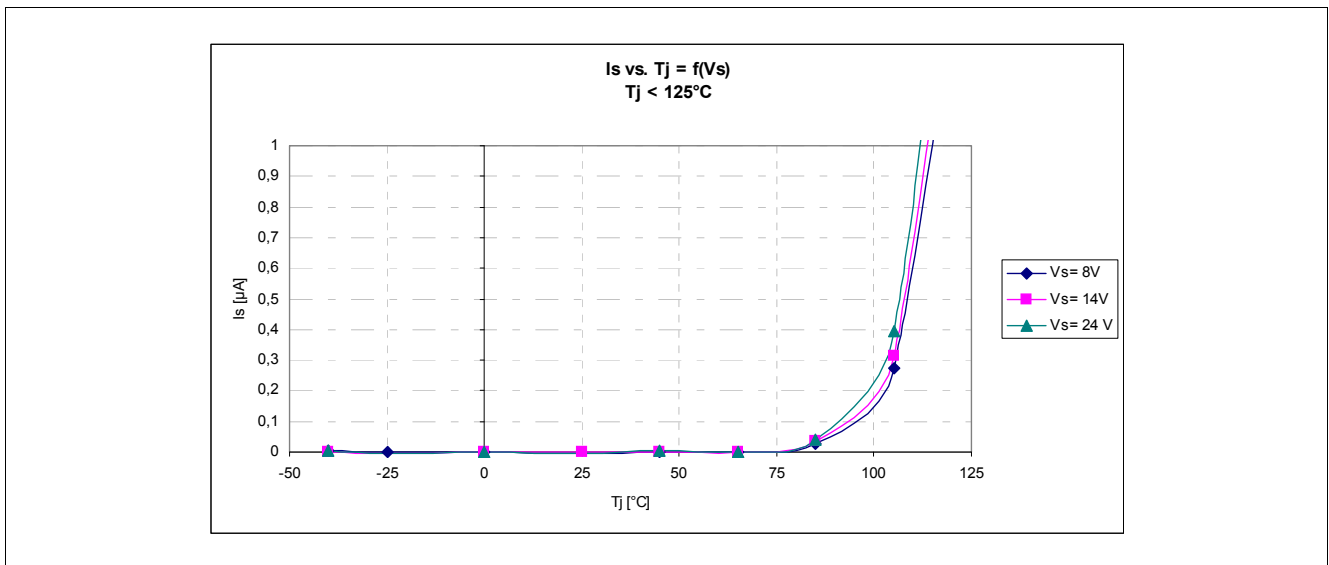

Figure 14 I_s vs $T_J = f(V_s)$, $T_J < 125\text{ °C}$

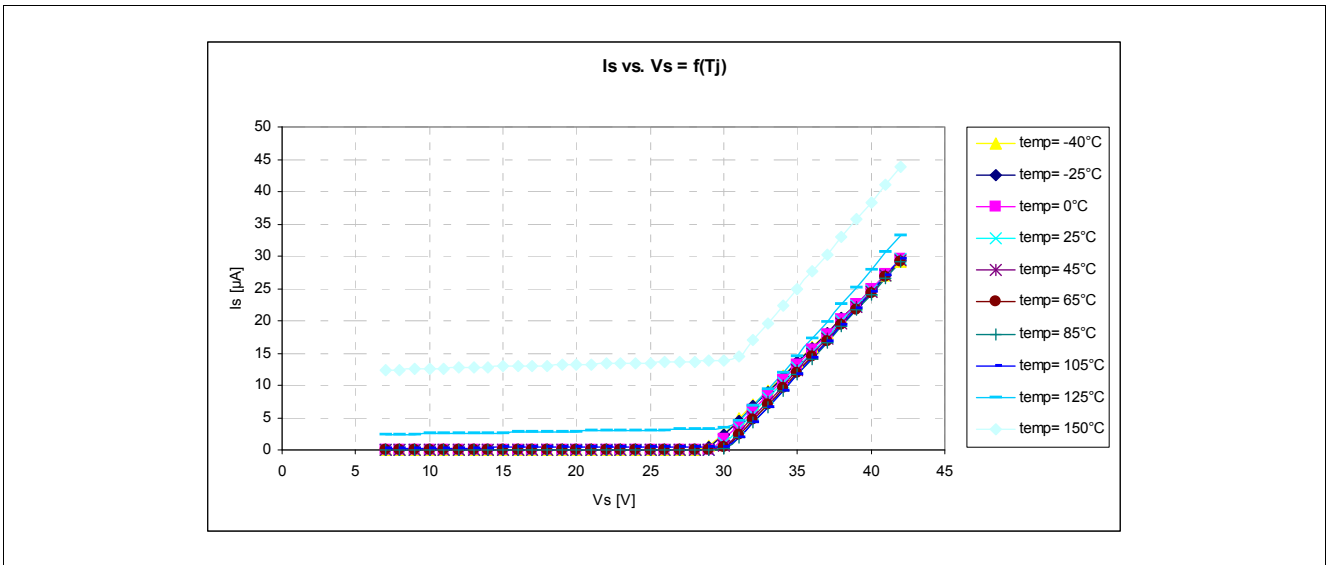

Figure 15 I_s vs $V_s = f(T_J)$

6 Application Information

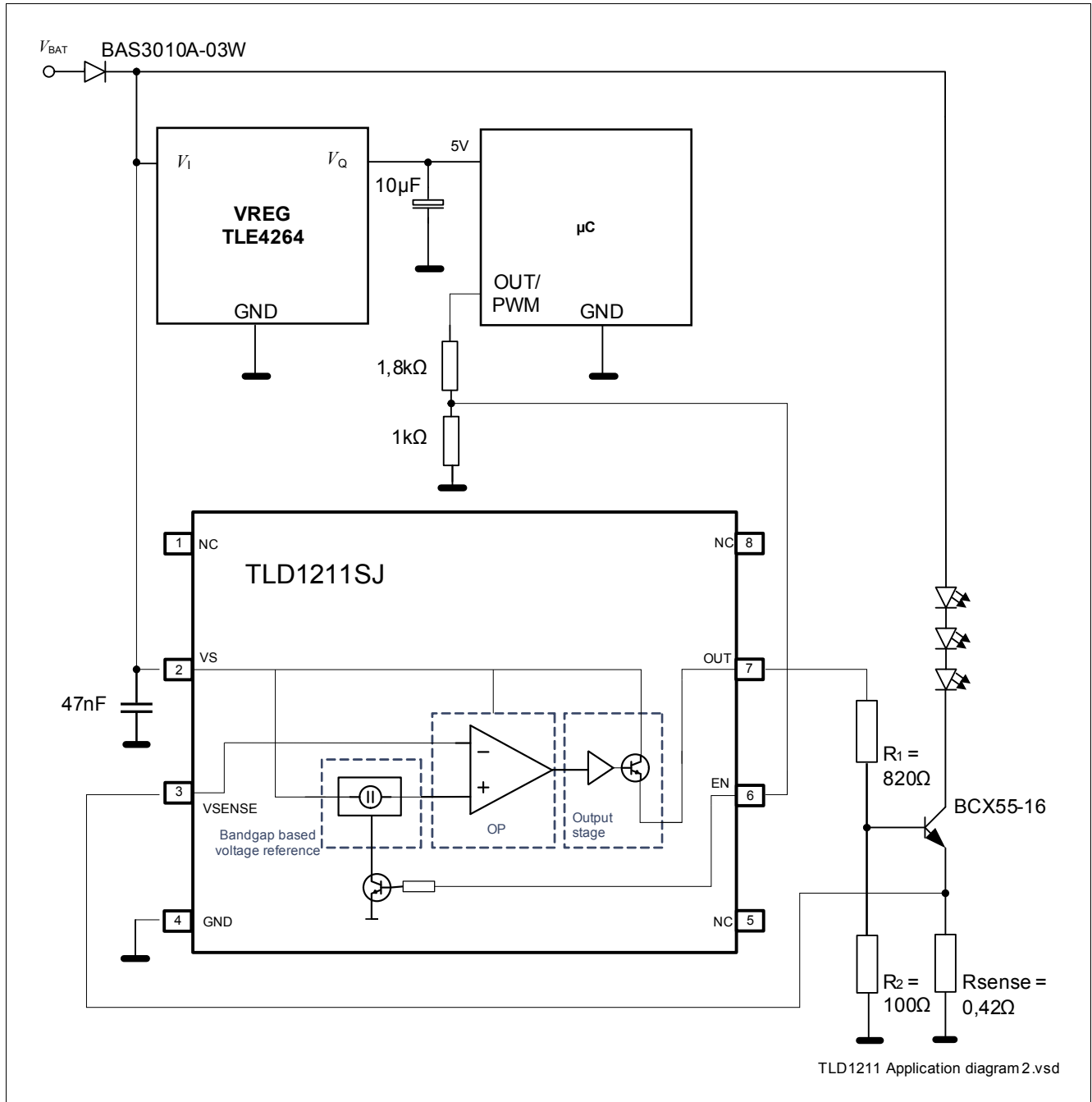

Figure 16 Application Information with External Output Stage

Note: This is a very simplified example of an application circuit. The function must be verified in the real application.

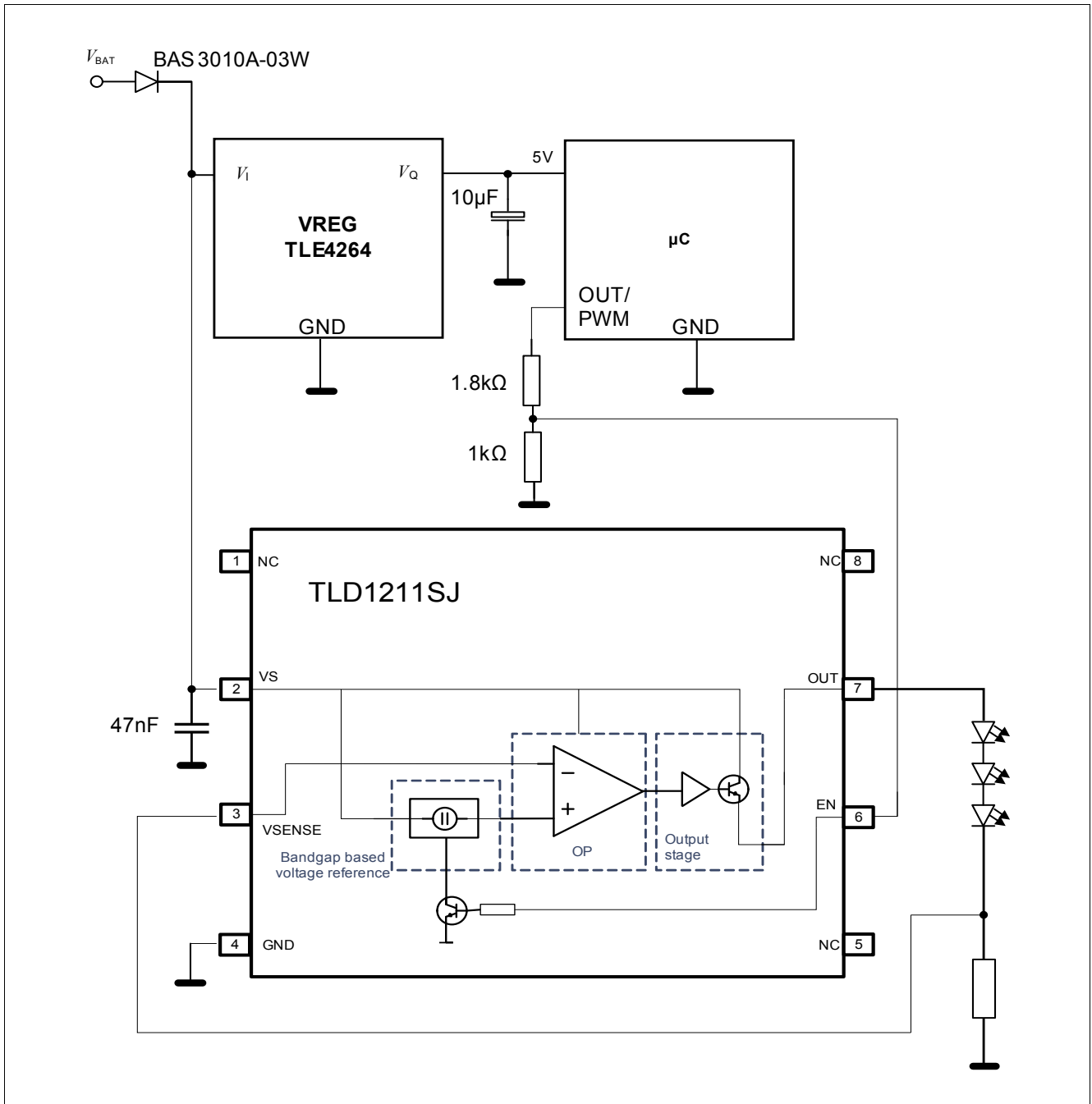

Figure 17 Application Information with Integrated Output Stage Usage

Note: This is a very simplified example of an application circuit. The function must be verified in the real application.

7 Package Outlines

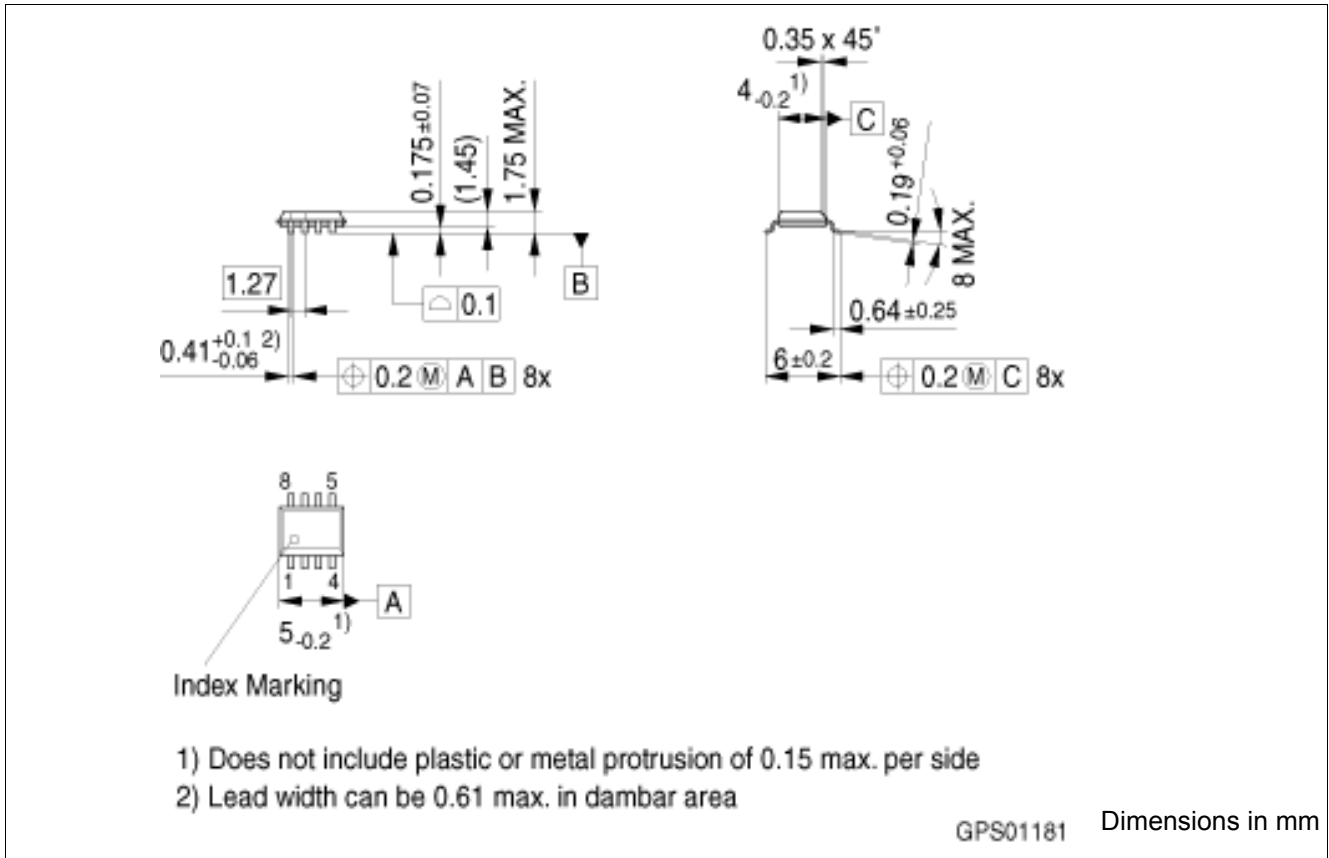

Figure 18 Package Outline; PG-DSO-8-16

Green Product (RoHS compliant)

To meet the world-wide customer requirements for environmentally friendly products and to be compliant with government regulations the device is available as a green product. Green products are RoHS-Compliant (i.e. Pb-free finish on leads and suitable for Pb-free soldering according to IPC/JEDEC J-STD-020).

For further information on alternative packages, please visit our website:
<http://www.infineon.com/packages>.

8 Revision History

Revision	Date	Changes
1.0	2010-03-26	Initial revision

Edition 2015-02-19

**Published by
Infineon Technologies AG
81726 Munich, Germany**

**© 2015 Infineon Technologies AG
All Rights Reserved.**

Legal Disclaimer

The information given in this document shall in no event be regarded as a guarantee of conditions or characteristics. With respect to any examples or hints given herein, any typical values stated herein and/or any information regarding the application of the device, Infineon Technologies hereby disclaims any and all warranties and liabilities of any kind, including without limitation, warranties of non-infringement of intellectual property rights of any third party.

Information

For further information on technology, delivery terms and conditions and prices, please contact the nearest Infineon Technologies Office (www.infineon.com).

Warnings

Due to technical requirements, components may contain dangerous substances. For information on the types in question, please contact the nearest Infineon Technologies Office.

Infineon Technologies components may be used in life-support devices or systems only with the express written approval of Infineon Technologies, if a failure of such components can reasonably be expected to cause the failure of that life-support device or system or to affect the safety or effectiveness of that device or system. Life support devices or systems are intended to be implanted in the human body or to support and/or maintain and sustain and/or protect human life. If they fail, it is reasonable to assume that the health of the user or other persons may be endangered.

Mouser Electronics

Authorized Distributor

Click to View Pricing, Inventory, Delivery & Lifecycle Information:

[Infineon:](#)

[TLD1211SJ](#)