

TVS Diodes

Transient Voltage Suppressor Diodes

TVS3V3L4U

Low Capacitance ESD / Transient / Surge Protection Array

TVS3V3L4U

Data Sheet

Revision 2.4, 2013-02-06
Final

Edition 2013-02-06

**Published by
Infineon Technologies AG
81726 Munich, Germany**

**© 2013 Infineon Technologies AG
All Rights Reserved.**

Legal Disclaimer

The information given in this document shall in no event be regarded as a guarantee of conditions or characteristics. With respect to any examples or hints given herein, any typical values stated herein and/or any information regarding the application of the device, Infineon Technologies hereby disclaims any and all warranties and liabilities of any kind, including without limitation, warranties of non-infringement of intellectual property rights of any third party.

Information

For further information on technology, delivery terms and conditions and prices, please contact the nearest Infineon Technologies Office (www.infineon.com).

Warnings

Due to technical requirements, components may contain dangerous substances. For information on the types in question, please contact the nearest Infineon Technologies Office.

Infineon Technologies components may be used in life-support devices or systems only with the express written approval of Infineon Technologies, if a failure of such components can reasonably be expected to cause the failure of that life-support device or system or to affect the safety or effectiveness of that device or system. Life support devices or systems are intended to be implanted in the human body or to support and/or maintain and sustain and/or protect human life. If they fail, it is reasonable to assume that the health of the user or other persons may be endangered.

Revision History: Rev. 2.3 2012-01-11

Page or Item	Subjects (major changes since previous revision)
Revision 2.4, 2013-02-06	
4	Halogen free deleted

Trademarks of Infineon Technologies AG

AURIX™, BlueMoon™, COMNEON™, C166™, CROSSAVE™, CanPAK™, CIPOS™, CoolMOS™, CoolSET™, CORECONTROL™, DAVE™, EasyPIM™, EconoBRIDGE™, EconoDUAL™, EconoPACK™, EconoPIM™, EiceDRIVER™, EUPEC™, FCOS™, HITFET™, HybridPACK™, ISOFACE™, I²RF™, IsoPACK™, MIPAQ™, ModSTACK™, my-d™, NovalithIC™, OmniTune™, OptiMOS™, ORIGA™, PROFET™, PRO-SIL™, PRIMARION™, PrimePACK™, RASIC™, ReverSave™, SatRIC™, SIEGET™, SINDRION™, SMARTi™, SmartLEWIS™, TEMPFET™, thinQ!™, TriCore™, TRENCHSTOP™, X-GOLD™, XMM™, X-PMU™, XPOSYS™.

Other Trademarks

Advance Design System™ (ADS) of Agilent Technologies, AMBA™, ARM™, MULTI-ICE™, PRIMECELL™, REALVIEW™, THUMB™ of ARM Limited, UK. AUTOSAR™ is licensed by AUTOSAR development partnership. Bluetooth™ of Bluetooth SIG Inc. CAT-iq™ of DECT Forum. COLOSSUS™, FirstGPS™ of Trimble Navigation Ltd. EMV™ of EMVCo, LLC (Visa Holdings Inc.). EPCOS™ of Epcos AG. FLEXGO™ of Microsoft Corporation. FlexRay™ is licensed by FlexRay Consortium. HYPERTERMINAL™ of Hilgraeve Incorporated. IEC™ of Commission Electrotechnique Internationale. IrDA™ of Infrared Data Association Corporation. ISO™ of INTERNATIONAL ORGANIZATION FOR STANDARDIZATION. MATLAB™ of MathWorks, Inc. MAXIM™ of Maxim Integrated Products, Inc. MICROTEC™, NUCLEUS™ of Mentor Graphics Corporation. Mifare™ of NXP. MIPI™ of MIPI Alliance, Inc. MIPS™ of MIPS Technologies, Inc., USA. muRata™ of MURATA MANUFACTURING CO., MICROWAVE OFFICE™ (MWO) of Applied Wave Research Inc., OmniVision™ of OmniVision Technologies, Inc. Openwave™ Openwave Systems Inc. RED HAT™ Red Hat, Inc. RFMD™ RF Micro Devices, Inc. SIRIUS™ of Sirius Sattelite Radio Inc. SOLARIS™ of Sun Microsystems, Inc. SPANSION™ of Spansion LLC Ltd. Symbian™ of Symbian Software Limited. TAIYO YUDEN™ of Taiyo Yuden Co. TEAKLITE™ of CEVA, Inc. TEKTRONIX™ of Tektronix Inc. TOKO™ of TOKO KABUSHIKI KAISHA TA. UNIX™ of X/Open Company Limited. VERILOG™, PALLADIUM™ of Cadence Design Systems, Inc. VLYNQ™ of Texas Instruments Incorporated. VXWORKS™, WIND RIVER™ of WIND RIVER SYSTEMS, INC. ZETEX™ of Diodes Zetex Limited.

Last Trademarks Update 2010-06-09

1 Low Capacitance ESD / Transient / Surge Protection Array

1.1 Features

- ESD/Transient/Surge protection according to:
IEC61000-4-2 (ESD): ±30 kV air/contact discharge
IEC61000-4-4 (EFT): ±80 A (5/50 ns)
IEC61000-4-5 (Surge): ±20 A (8/20 μs)
- Reverse working voltage maximum: $V_{RWM} = 3.3\text{ V}$
- Low leakage current: $I_R < 50\text{ nA}$
- **Low capacitance: $C_L = 2\text{ pF typ. (I/O to GND)}$, $1\text{ pF typ. (I/O to I/O)}$**
- Low clamping voltage: $V_{CL} = 7.7\text{ V typ. @ }20\text{ A (8/20 } \mu\text{s)}$
- Pb-free (RoHS compliant) package



1.2 Application Examples

- 10/100/1000 Ethernet
- 4 lines uni-directional (Pin 2 to GND)
- 2 lines bi-directional (Pin 2 n.c.)

1.3 Product Description

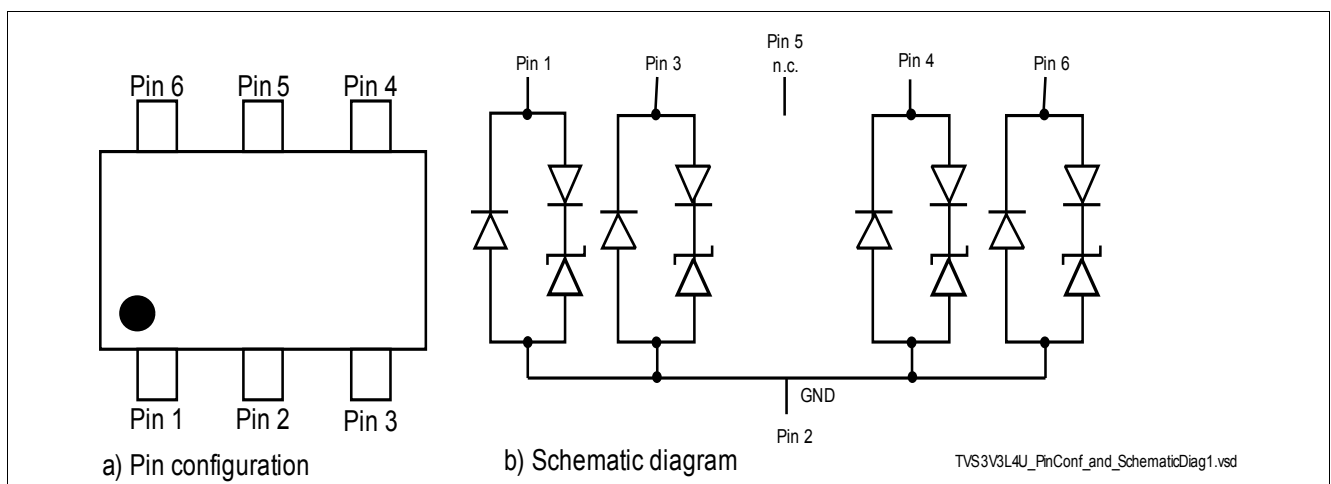

Figure 1-1 Pin configuration and Schematic diagram

Table 1-1 Ordering Information

Type	Package	Configuration	Marking code
TVS3V3L4U	SC74	4 lines, uni-directional or 2 lines, bidirectional	E1s

2 Electrical Characteristics

2.1 Maximum Ratings

Table 2-1 Maximum Ratings at $T_A = 25\text{ °C}$, unless otherwise specified

Parameter	Symbol	Values			Unit
		Min.	Typ.	Max.	
ESD discharge ¹⁾ air contact	V_{ESD}	-30 -30	– –	30 30	kV
Peak pulse current ($t_P = 8/20\ \mu\text{s}$) ²⁾	I_{PP}	-20	–	20	A
Peak pulse power $t_P = 8/20\ \mu\text{s}$ ²⁾ $t_P = 100\ \text{ns}$ ³⁾	P_{PK}	– –	– –	154 1044	W
Operating temperature	T_{OP}	-55	–	125	°C
Storage temperature	T_{stg}	-55	–	150	°C

1) V_{ESD} according to IEC61000-4-2

2) I_{PP} according to IEC61000-4-5. P_{PK} is calculated by $I_{\text{PP}} \times V_{\text{CL}}$.

3) Please refer to AN210[1]. P_{PK} is calculated by $I_{\text{TLP}} \times V_{\text{CL}}$.

Attention: Stresses above the max. values listed here may cause permanent damage to the device. Exposure to absolute maximum rating conditions for extended periods may affect device reliability. Maximum ratings are absolute ratings; exceeding only one of these values may cause irreversible damage to the integrated circuit.

2.2 DC Characteristics

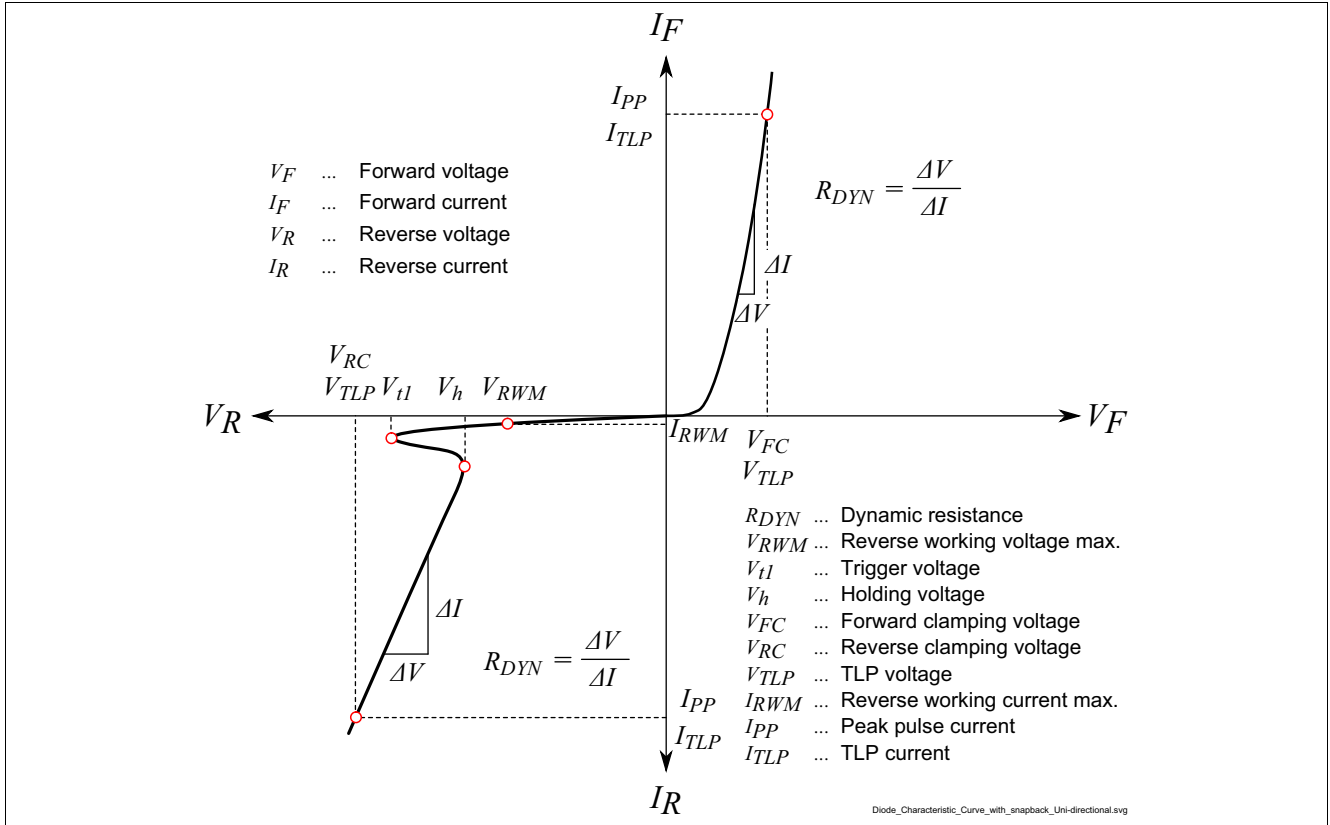

Figure 2-1 Definitions of electrical characteristics

Table 2-2 DC Characteristics at $T_A = 25\text{ °C}$, unless otherwise specified

Parameter	Symbol	Values			Unit	Note / Test Condition
		Min.	Typ.	Max.		
Reverse working voltage	V_{RWM}	–	–	3.3	V	
Reverse current	I_R	–	–	50	nA	$V_R = 3.3\text{ V}$

2.3 RF Characteristics

Table 2-3 RF Characteristics at $T_A = 25\text{ °C}$, unless otherwise specified

Parameter	Symbol	Values			Unit	Note / Test Condition
		Min.	Typ.	Max.		
Line capacitance I/O to GND	C_L	–	2	3	pF	$V_R = 0\text{ V}, f = 1\text{ MHz}$
I/O to I/O		–	1	–		

2.4 ESD Characteristics
Table 2-4 ESD Characteristics at $T_A = 25\text{ °C}$, unless otherwise specified

Parameter	Symbol	Values			Unit	Note / Test Condition
		Min.	Typ.	Max.		
Reverse clamping voltage ¹⁾ I/O to GND	V_{CL}	–	4.2	–	V	$t_p = 8/20\ \mu\text{s}$ $I_{PP} = 1\ \text{A}$
I/O to GND		–	4.9	–		$I_{PP} = 5\ \text{A}$
I/O to GND		–	5.8	–		$I_{PP} = 10\ \text{A}$
I/O to GND		–	6.7	–		$I_{PP} = 15\ \text{A}$
I/O to GND		–	7.7	–		$I_{PP} = 20\ \text{A}$
Reverse clamping voltage ²⁾ I/O to GND		–	5.8	–		$t_p = 100\ \text{ns}$ $I_{PP} = 16\ \text{A}_{PP}$
Forward clamping voltage ¹⁾ GND to I/O	V_{FC}	–	1.1	–	V	$t_p = 8/20\ \mu\text{s}$ $I_{PP} = 1\ \text{A}$
GND to I/O		–	4	–		$I_{PP} = 20\ \text{A}$
Forward clamping voltage ²⁾ GND to I/O	–	3.1	–	$t_p = 100\ \text{ns}$ $I_{PP} = 16\ \text{A}$		
Dynamic resistance ¹⁾ I/O to GND	R_{DYN}	–	0.15	–	Ω	$t_p = 8/20\ \mu\text{s}$
Dynamic resistance ²⁾ I/O to GND		–	0.09	–		$t_p = 100\ \text{ns}$

1) I_{PP} according to IEC61000-4-5

2) Please refer to Application Note AN210 [1]. TLP parameter: $Z_0 = 50\ \Omega$, $t_p = 100\ \text{ns}$, $t_r = 300\ \text{ps}$, averaging window: $t_1 = 30\ \text{ns}$ to $t_2 = 60\ \text{ns}$, extraction of dynamic resistance using least squares fit of TLP characteristics between $I_{PP1} = 10\ \text{A}$ and $I_{PP2} = 40\ \text{A}$.

3 Typical Characteristic

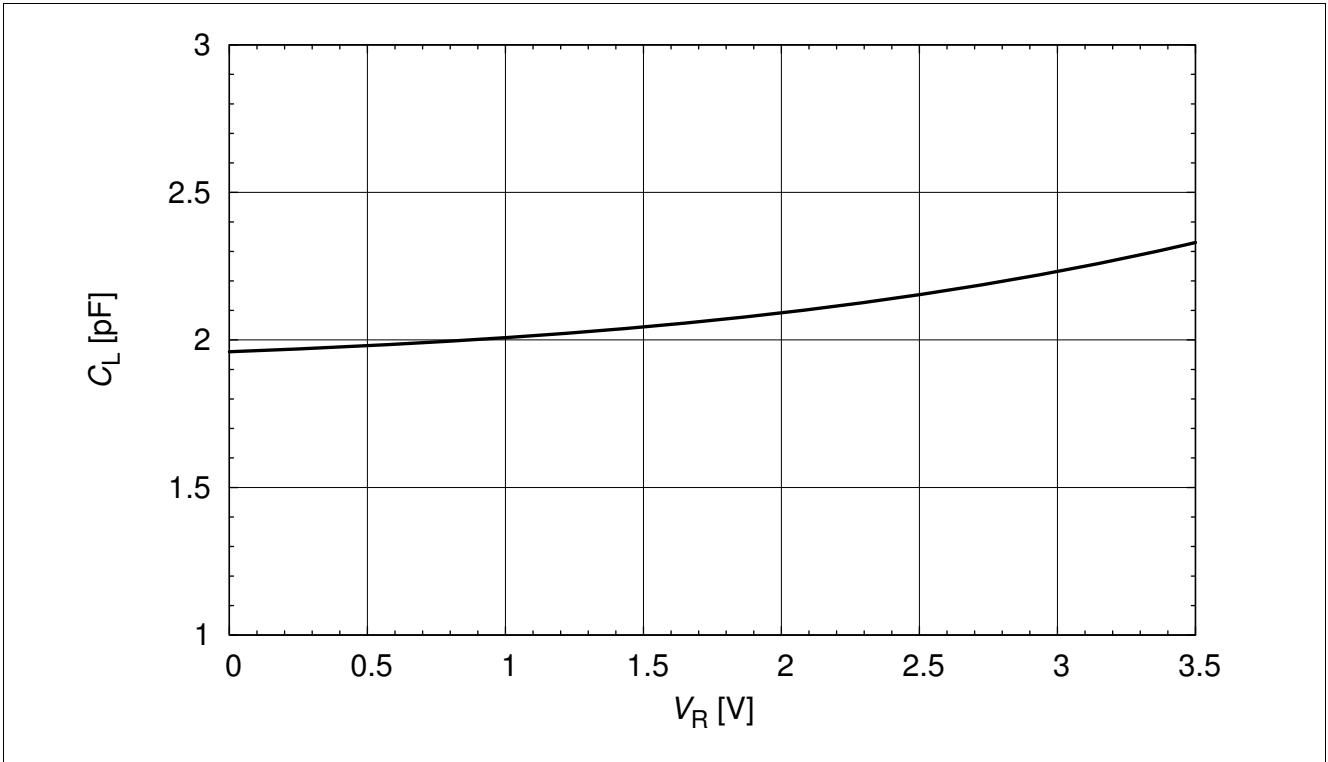

Figure 3-1 Line capacitance $C_L = f(V_R)$

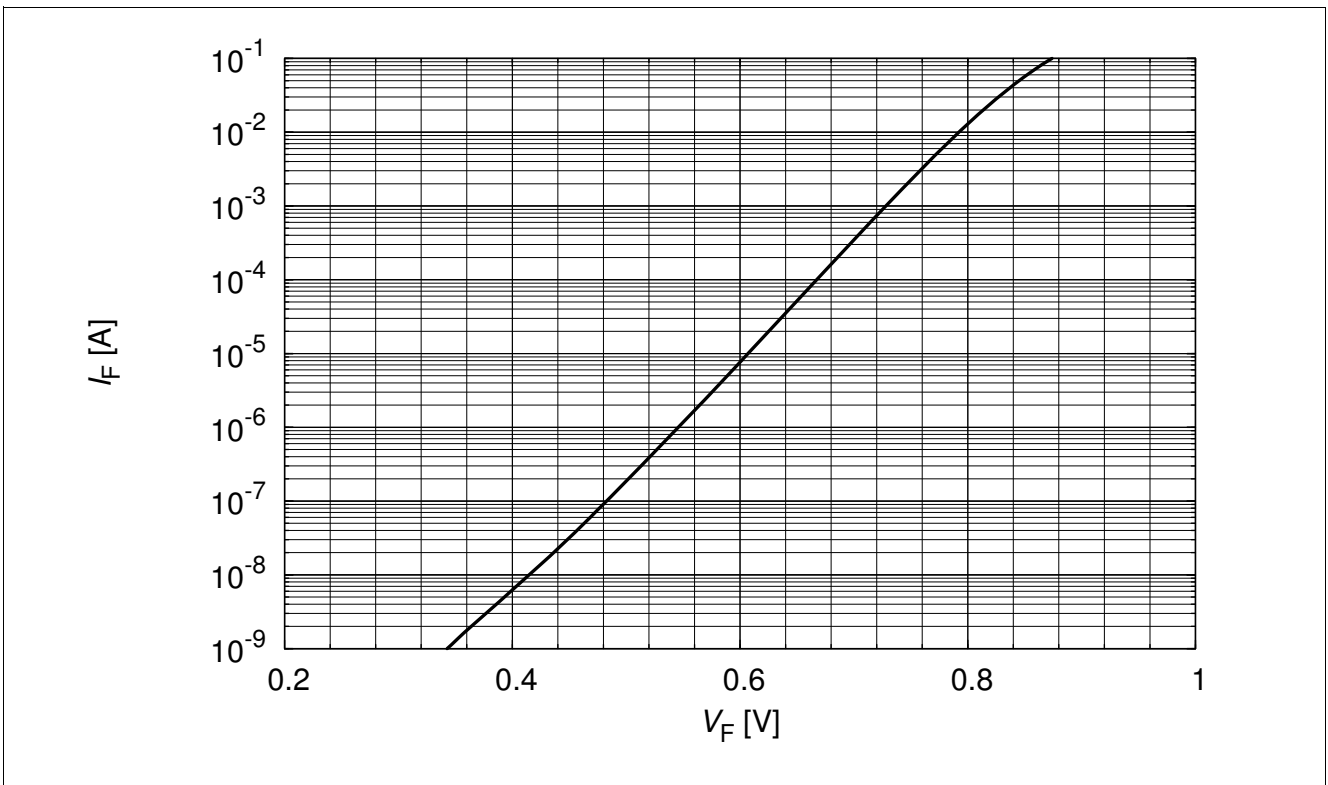

Figure 3-2 Forward characteristic, $I_F = f(V_F)$

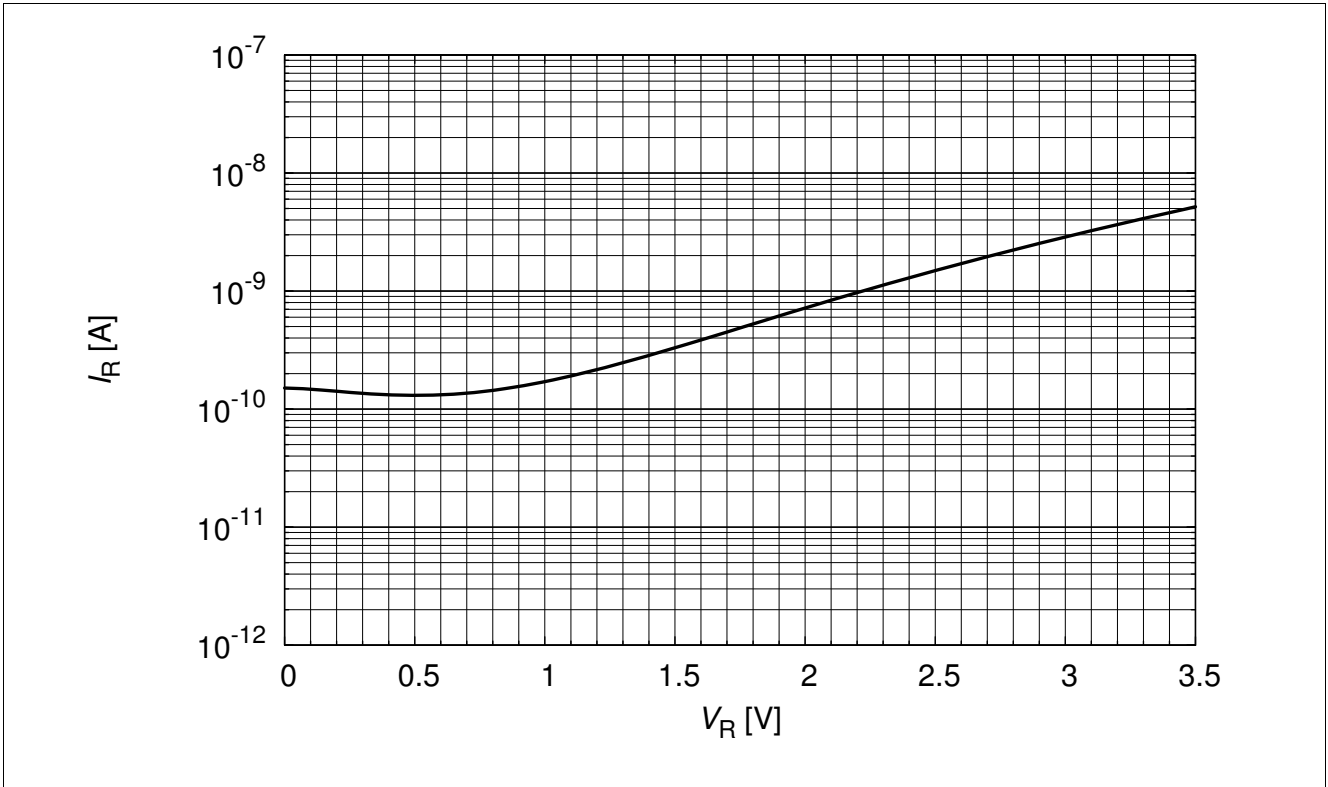

Figure 3-3 Reverse current, $I_R = f(V_R)$

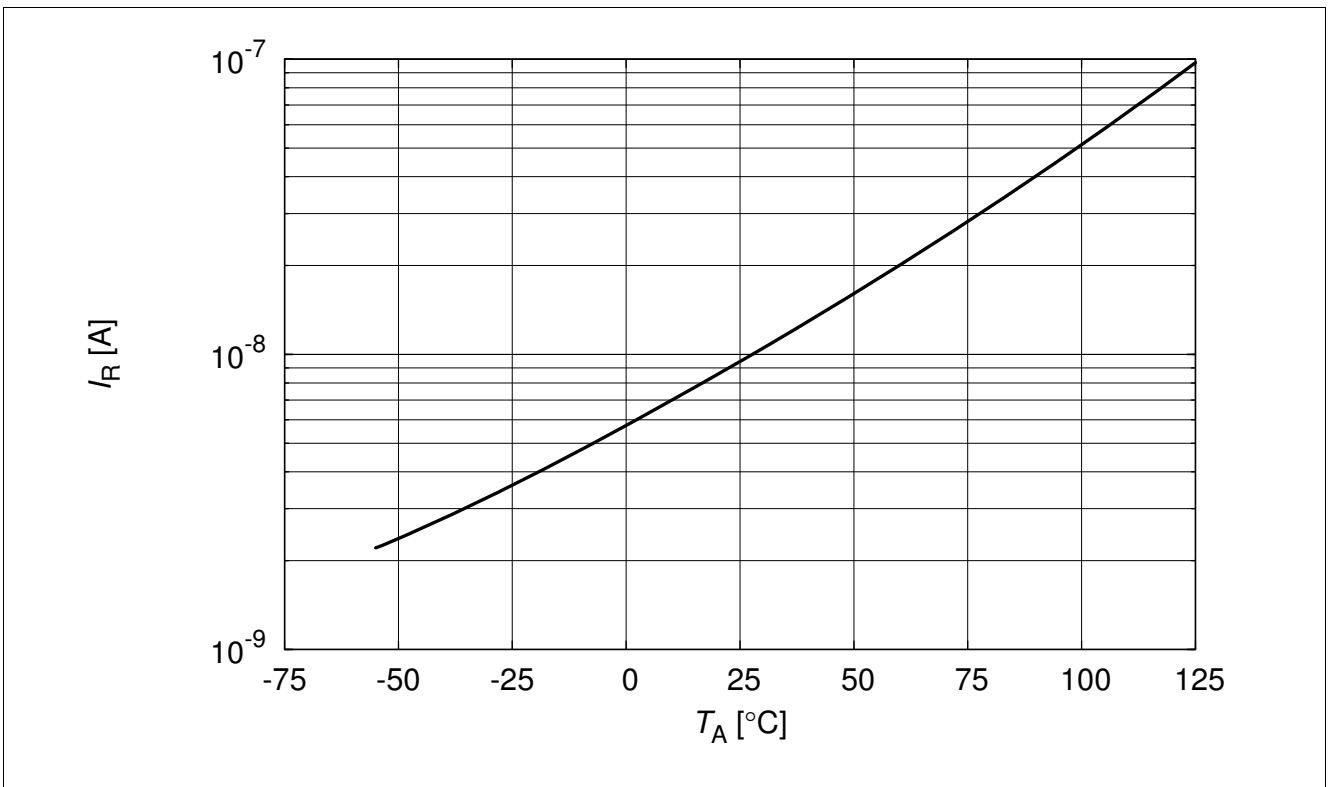

Figure 3-4 Reverse current $I_R = f(T_A)$, $V_R = 3.3$ V

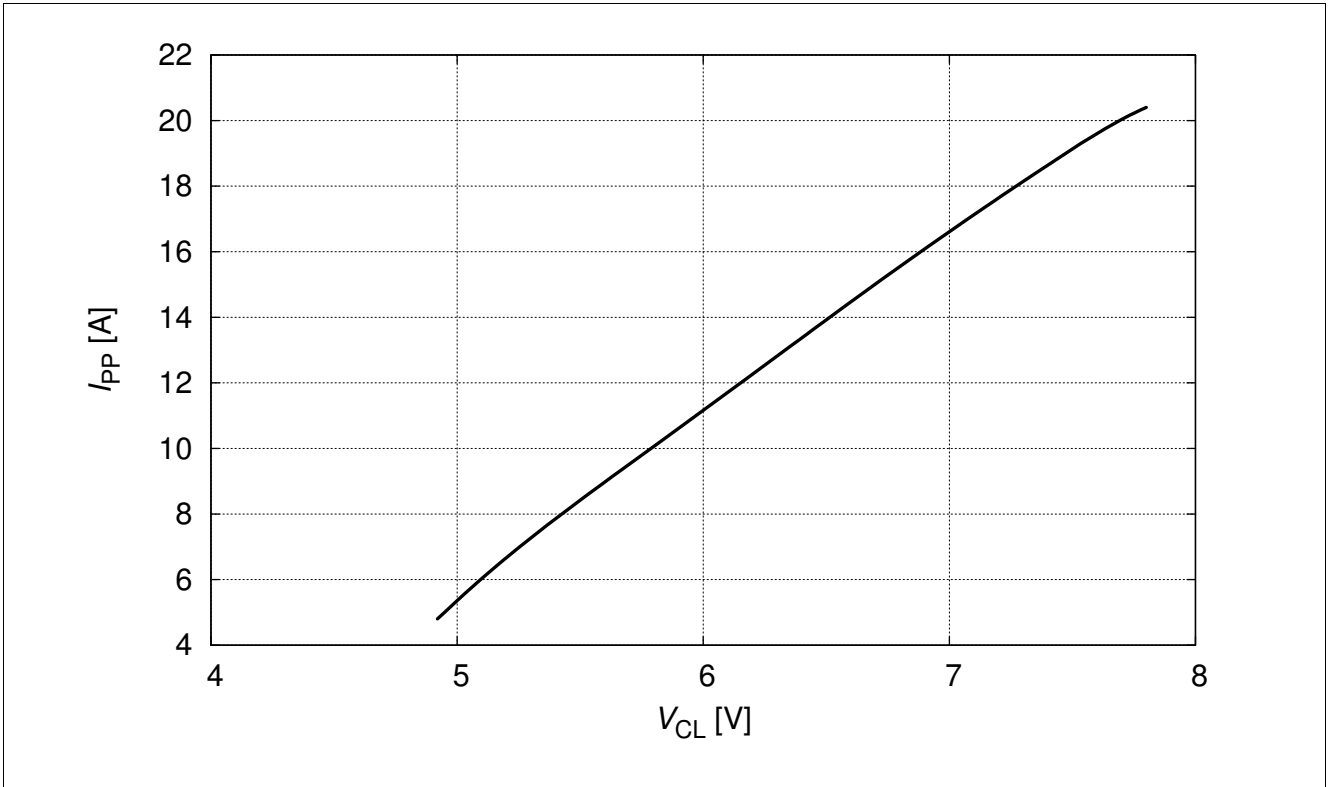

Figure 3-5 Pulse reverse current (IEC61000-4-5) versus clamping voltage, $I_{PP} = f(V_{CL})$

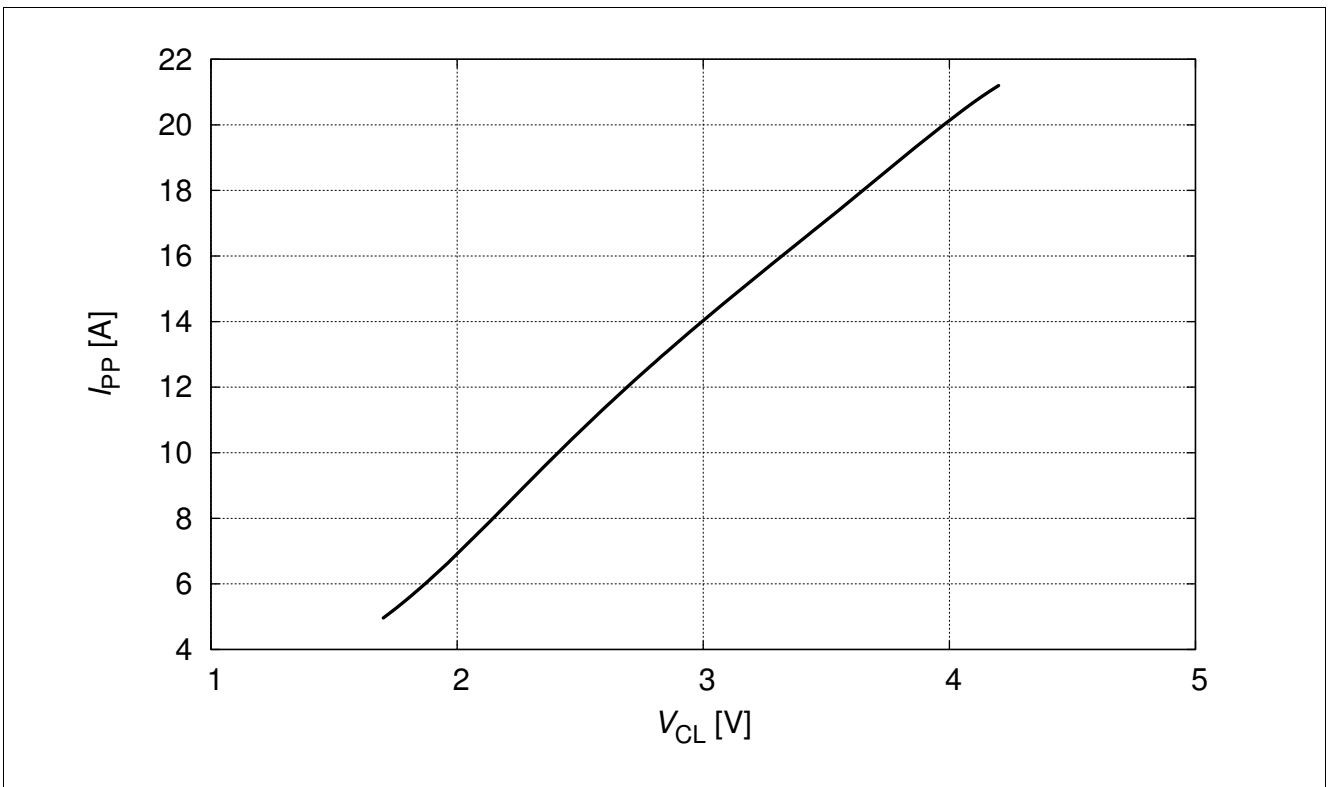

Figure 3-6 Pulse forward current (IEC61000-4-5) versus clamping voltage, $I_{PP} = f(V_{CL})$

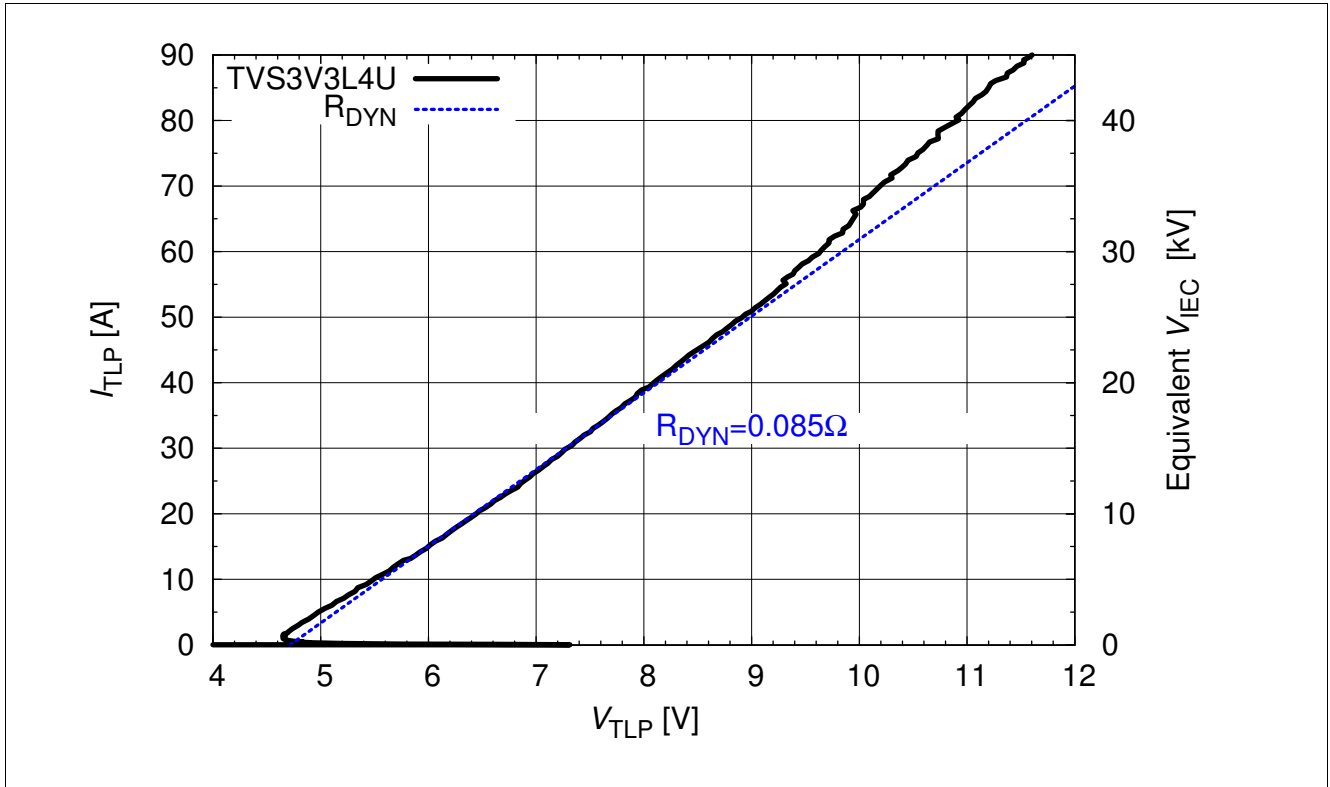

Figure 3-7 TLP characteristics, reverse pulse

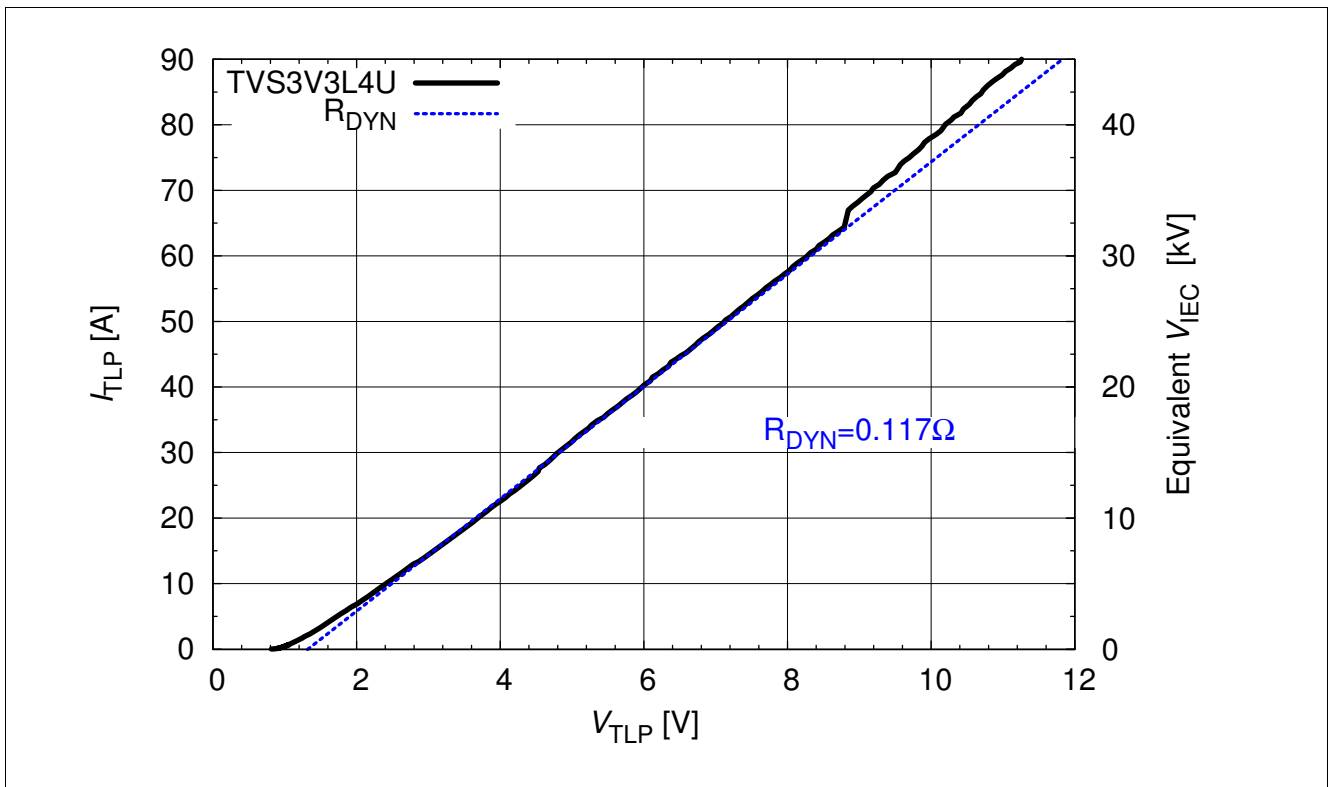

Figure 3-8 TLP characteristics, forward pulse

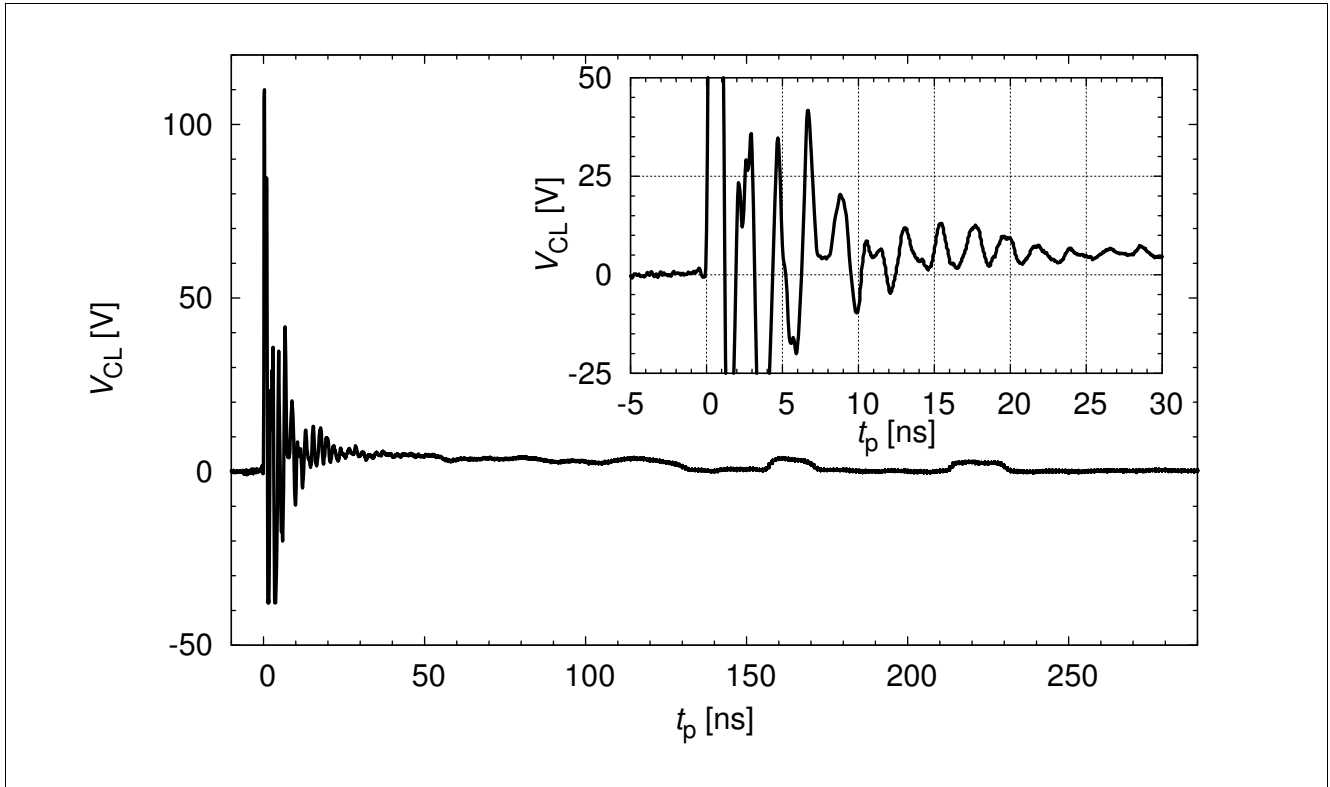

Figure 3-9 Clamping voltage at +8 kV contact discharge according IEC61000-4-2 ($R = 330 \Omega$, $C = 150 \text{ pF}$)

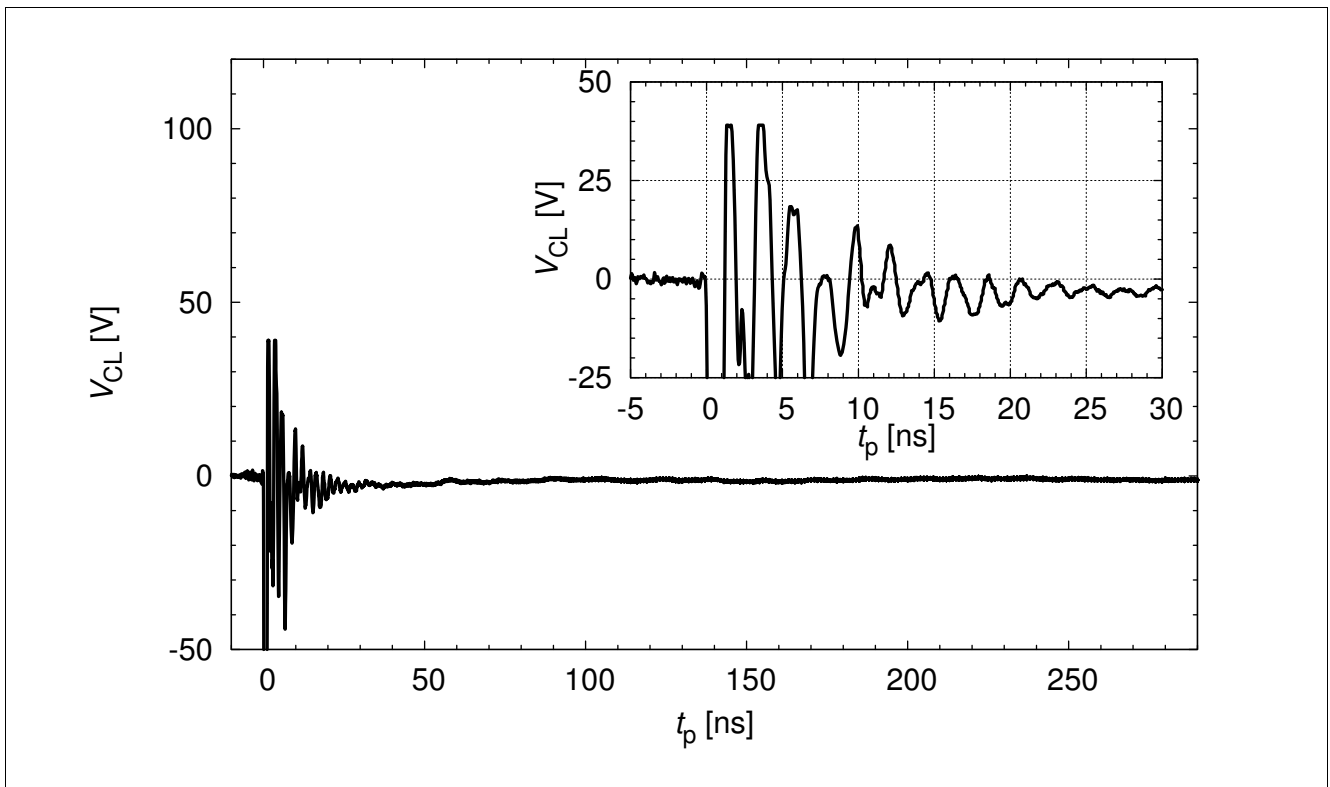

Figure 3-10 Clamping voltage at -8 kV contact discharge according IEC61000-4-2 ($R = 330 \Omega$, $C = 150 \text{ pF}$)

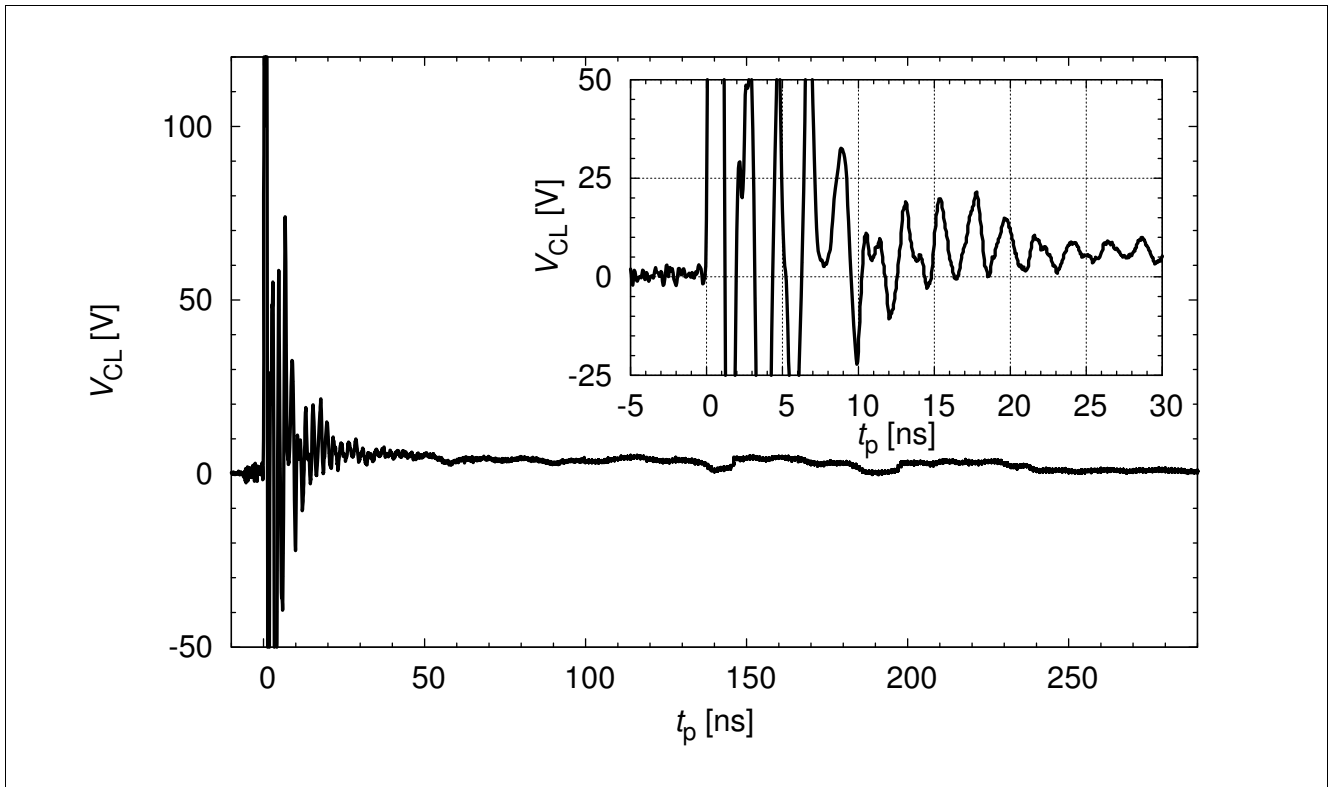

Figure 3-11 Clamping voltage at +15 kV contact discharge according IEC61000-4-2 ($R = 330 \Omega$, $C = 150 \text{ pF}$)

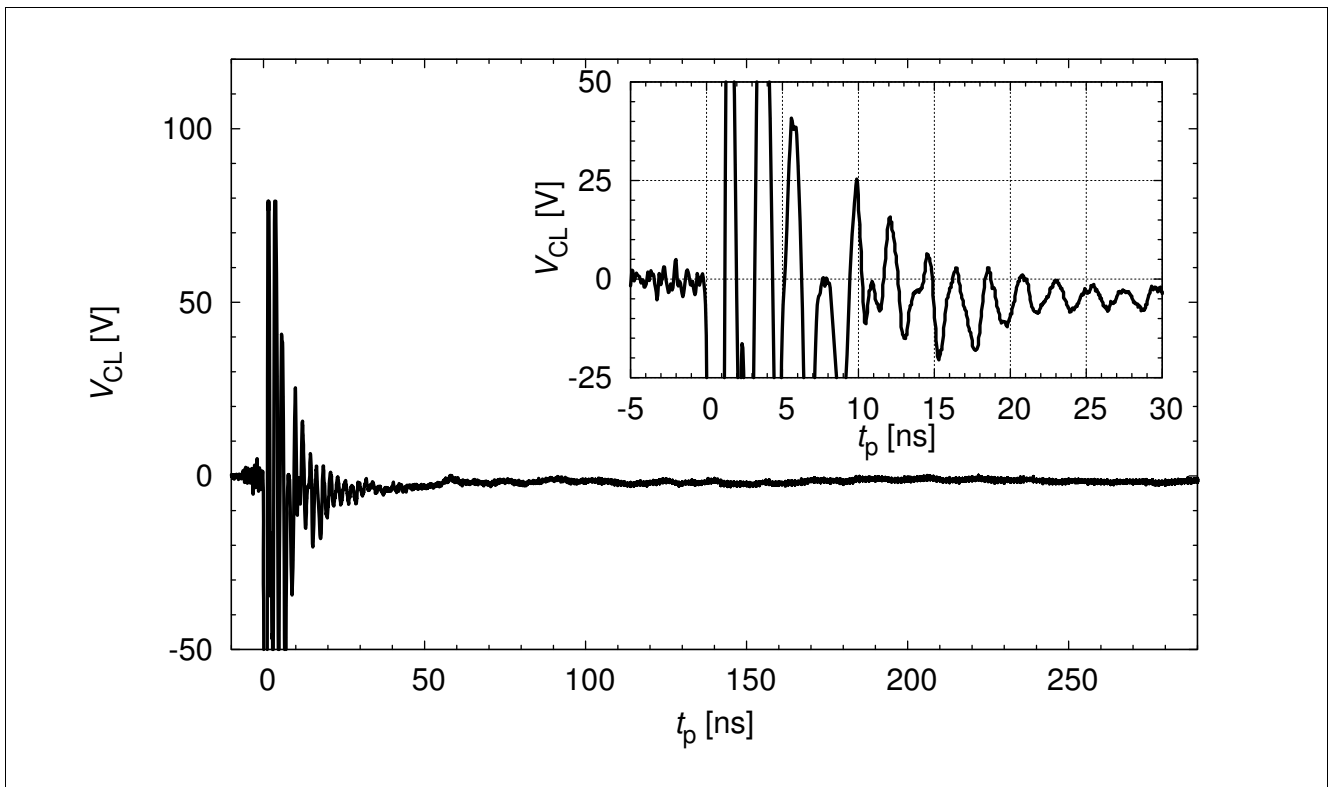

Figure 3-12 Clamping voltage at -15 kV contact discharge according IEC61000-4-2 ($R = 330 \Omega$, $C = 150 \text{ pF}$)

4 Package Information

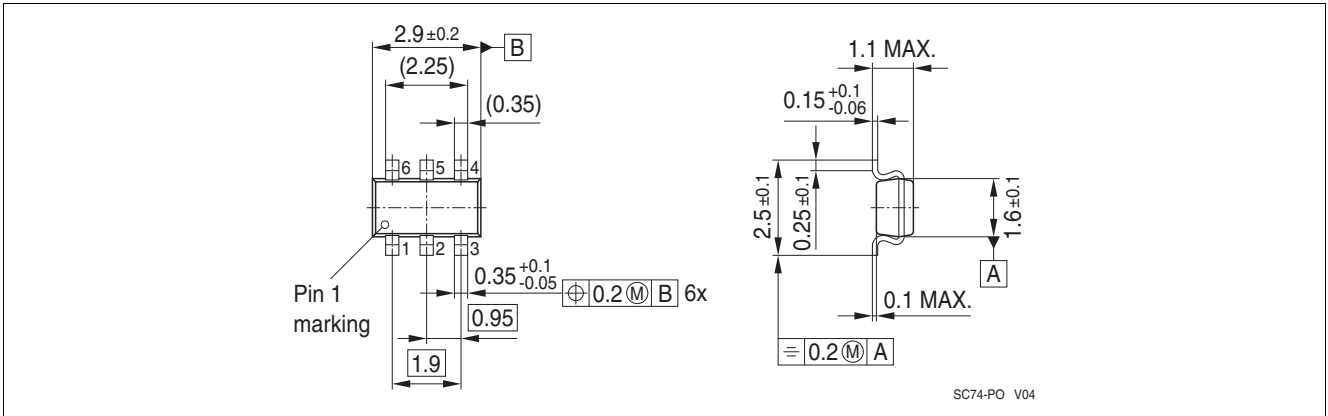

Figure 4-1 SC74 Package outline

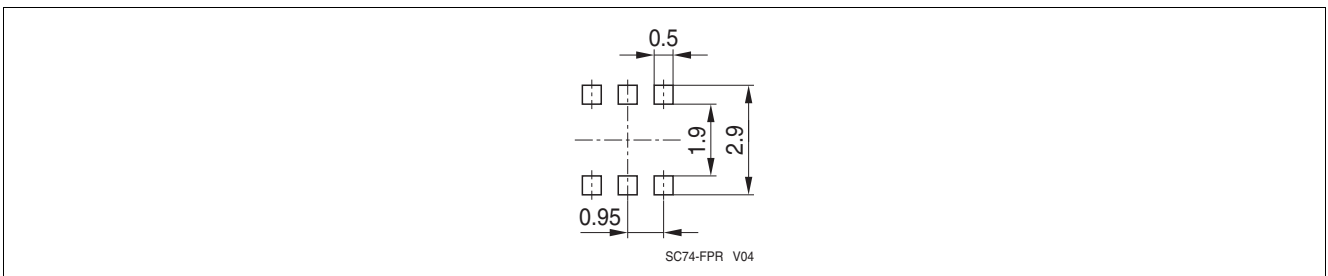

Figure 4-2 SC74 Footprint (Reflow Soldering)

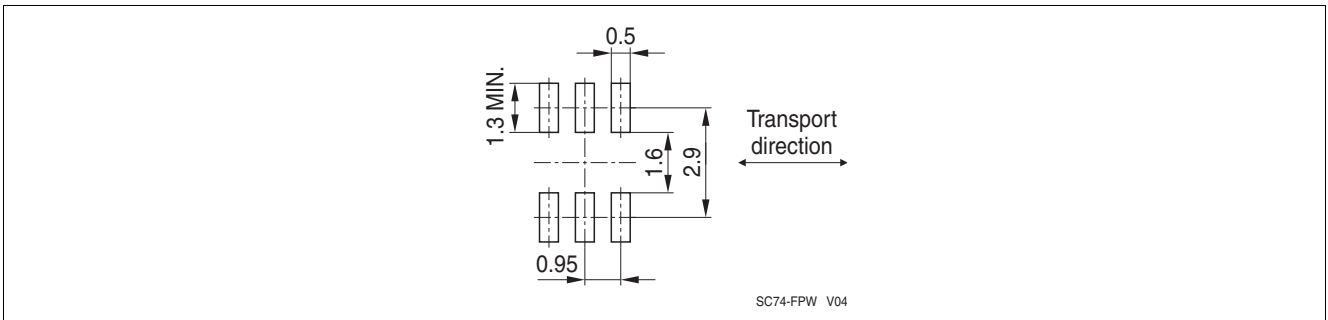

Figure 4-3 SC74 Footprint (Reflow Soldering)

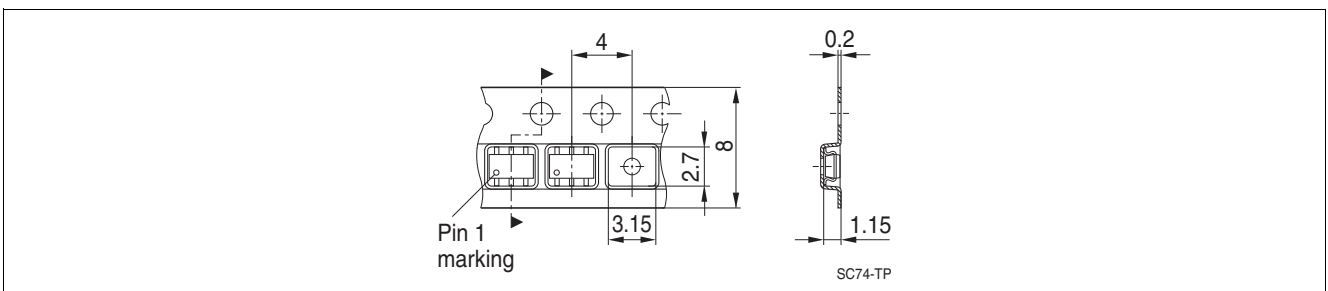

Figure 4-4 SC74 Packing

References

- [1] Infineon AG - **Application Note AN210**: Effective ESD Protection Design at System Level using VF-TLP Characterization Methodology
- [2] Infineon AG - Recommendations for PCB Assembly of Infineon TSLP and TSSLP Packages

www.infineon.com

Published by Infineon Technologies AG

Mouser Electronics

Authorized Distributor

Click to View Pricing, Inventory, Delivery & Lifecycle Information:

[Infineon:](#)

[TVS3V3L4UE6327HTSA1](#) [TVS3V3L4U E6327](#)