

# MOSFET

Metal Oxide Semiconductor Field Effect Transistor

## CoolMOS™ C3 800V

800V CoolMOS™ C3 Power Transistor  
SPW55N80C3

## Data Sheet

Rev. 2.0  
Final

Industrial & Multimarket

## 1 Description

800V CoolMOS™ C3 designed for:

- Industrial application with high DC bulk voltage
- Switching Application (i.e. active clamp forward)

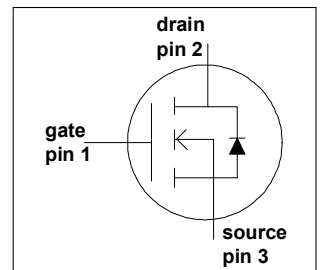
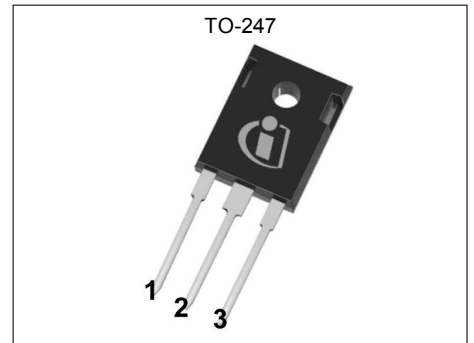
### Features

New revolutionary high voltage technology

- Extreme dv/dt rated
- High peak current capability
- Qualified according to JEDEC1) for target applications
- Pb-free lead plating; RoHS compliant
- Ultra low gate charge
- Ultra low effective capacitances

### Applications

PFC stages, hard switching PWM stages and resonant switching PWM stages for e.g. PC Silverbox, Adapter, LCD & PDP TV, Lighting, Server, Telecom, UPS and Solar.



**Table 1 Key Performance Parameters**

Parameter	Value	Unit
$V_{DS} @ T_{j, max}$	850	V
$R_{DS(on), max}$	0.085	$\Omega$
$Q_g, typ$	288	nC
$I_{D, pulse}$	150	A
$E_{oss} @ 400V$	21.5	$\mu J$
Body diode $di/dt$	100	$A/\mu s$



Type / Ordering Code	Package	Marking	Related Links
SPW55N80C3	PG-TO 247	55N80C3	see Appendix A



**Table of Contents**

Description ..... 2

Table of Contents ..... 3

Maximum ratings ..... 4

Thermal characteristics ..... 5

Electrical characteristics ..... 6

Electrical characteristics diagrams ..... 8

Test Circuits ..... 12

Package Outlines ..... 13

Appendix A ..... 14

Revision History ..... 15

Disclaimer ..... 15

## 2 Maximum ratings

at  $T_j = 25^\circ\text{C}$ , unless otherwise specified

**Table 2 Maximum ratings**

Parameter	Symbol	Values			Unit	Note / Test Condition
		Min.	Typ.	Max.		
Continuous drain current <sup>1)</sup>	$I_D$			54.9	A	$T_C = 25^\circ\text{C}$
				34.7		$T_C = 100^\circ\text{C}$
Pulsed drain current <sup>2)</sup>	$I_{D,pulse}$			150	A	$T_C = 25^\circ\text{C}$
Avalanche energy, single pulse	$E_{AS}$			2150	mJ	$I_b = 9.5\text{A}$ , $V_{DD} = 50\text{V}$
Avalanche energy, repetitive	$E_{AR}$			3.26	mJ	$I_b = 9.5\text{A}$ , $V_{DD} = 50\text{V}$
Avalanche current, repetitive	$I_{AR}$			9.5	A	
MOSFET dv/dt ruggedness	dv/dt			50	V/ns	$V_{DS} = 0 \dots 400\text{V}$
Gate source voltage	$V_{GS}$	-20		20	V	static
		-30		30		AC ( $f > 1\text{Hz}$ )
Power dissipation (non FullPAK) TO-247	$P_{tot}$			500.0	W	$T_C = 25^\circ\text{C}$
Operating and storage temperature	$T_j, T_{stg}$	-55		150	$^\circ\text{C}$	
Mounting torque (non FullPAK) TO-247				60	Ncm	M3 and M3.5 screws
Continuous diode forward current	$I_S$			47.6	A	$T_C = 25^\circ\text{C}$
Diode pulse current	$I_{S,pulse}$			150	A	$T_C = 25^\circ\text{C}$
Reverse diode dv/dt <sup>3)</sup>	dv/dt			4	V/ns	$V_{DS} = 0 \dots 400\text{V}$ , $I_{SD} \leq I_b$ , $T_j = 25^\circ\text{C}$
Maximum diode commutation speed	$di_f/dt$			100	A/ $\mu\text{s}$	

<sup>1)</sup> Limited by  $T_{j,max}$ . Maximum duty cycle  $D=0.75$

<sup>2)</sup> Pulse width  $t_p$  limited by  $T_{j,max}$

<sup>3)</sup>  $V_{peak} < V_{(BR)DSS}$ ,  $T_j < T_{j,max}$ , identical low and high side switch with same  $R_g$

### 3 Thermal characteristics

**Table 3 Thermal characteristics TO-247**

Parameter	Symbol	Values			Unit	Note / Test Condition
		Min.	Typ.	Max.		
Thermal resistance, junction - case	$R_{thJC}$			0.25	°C/W	
Thermal resistance, junction - ambient	$R_{thJA}$			62	°C/W	leaded
Soldering temperature, wavesoldering only allowed at leads	$T_{sold}$			260	°C	1.6 mm (0.063 in.) from case for 10s

## 4 Electrical characteristics

at  $T_j = 25^\circ\text{C}$ , unless otherwise specified

**Table 4 Static characteristics**

Parameter	Symbol	Values			Unit	Note / Test Condition
		Min.	Typ.	Max.		
Drain-source breakdown voltage	$V_{(BR)DSS}$	800			V	$V_{GS} = 0V, I_D = 0.25mA$
Gate threshold voltage	$V_{GS(th)}$	2.1	3	3.9	V	$V_{DS} = V_{GS}, I_D = 3.3mA$
Zero gate voltage drain current	$I_{DSS}$			25	$\mu A$	$V_{DS} = 800V, V_{GS} = 0V, T_j = 25^\circ C$
			150			$V_{DS} = 800V, V_{GS} = 0V, T_j = 150^\circ C$
Gate-source leakage current	$I_{GSS}$			100	nA	$V_{GS} = 20V, V_{DS} = 0V$
Drain-source on-state resistance	$R_{DS(on)}$		0.077	0.085	$\Omega$	$V_{GS} = 10V, I_D = 32.6A, T_j = 25^\circ C$
			0.199			$V_{GS} = 10V, I_D = 32.6A, T_j = 150^\circ C$
Gate resistance	$R_G$		0.8		$\Omega$	$f = 1MHz, \text{open drain}$

**Table 5 Dynamic characteristics**

Parameter	Symbol	Values			Unit	Note / Test Condition
		Min.	Typ.	Max.		
Input capacitance	$C_{iss}$		7520		pF	$V_{GS} = 0V, V_{DS} = 100V, f = 1MHz$
Output capacitance	$C_{oss}$		305		pF	
Effective output capacitance, energy related <sup>1)</sup>	$C_{o(er)}$		1535		pF	$V_{GS} = 0V, V_{DS} = 0 \dots 400V$
Effective output capacitance, time related <sup>2)</sup>	$C_{o(tr)}$		277		pF	$I_D = \text{constant}, V_{GS} = 0V, V_{DS} = 0 \dots 400V$
Turn-on delay time	$t_{d(on)}$		45		ns	$V_{DD} = 400V, V_{GS} = 13V, I_D = 54.9A, R_G = 3.4\Omega$
Rise time	$t_r$		21		ns	
Turn-off delay time	$t_{d(off)}$		200		ns	
Fall time	$t_f$		9		ns	

**Table 6 Gate charge characteristics**

Parameter	Symbol	Values			Unit	Note / Test Condition
		Min.	Typ.	Max.		
Gate to source charge	$Q_{gs}$		42		nC	$V_{DD} = 480V, I_D = 54.9A, V_{GS} = 0 \text{ to } 10V$
Gate to drain charge	$Q_{gd}$		125		nC	
Gate charge total	$Q_g$		288		nC	
Gate plateau voltage	$V_{plateau}$		5.5		V	

<sup>1)</sup>  $C_{o(er)}$  is a fixed capacitance that gives the same stored energy as  $C_{oss}$  while  $V_{DS}$  is rising from 0 to 400V

<sup>2)</sup>  $C_{o(tr)}$  is a fixed capacitance that gives the same charging time as  $C_{oss}$  while  $V_{DS}$  is rising from 0 to 400V

**Table 7 Reverse diode characteristics**

Parameter	Symbol	Values			Unit	Note / Test Condition
		Min.	Typ.	Max.		
Diode forward voltage	$V_{SD}$		0.95		V	$V_{GS} = 0V, I_F = 54.9A, T_j = 25^\circ C$
Reverse recovery time	$t_{rr}$		1050		ns	$V_R = 400V, I_F = 54.9A, dI/dt = 100A/\mu s$
Reverse recovery charge	$Q_{rr}$		43		$\mu C$	
Peak reverse recovery current	$I_{rrm}$		78		A	

### 5 Electrical characteristics diagrams

Table 8

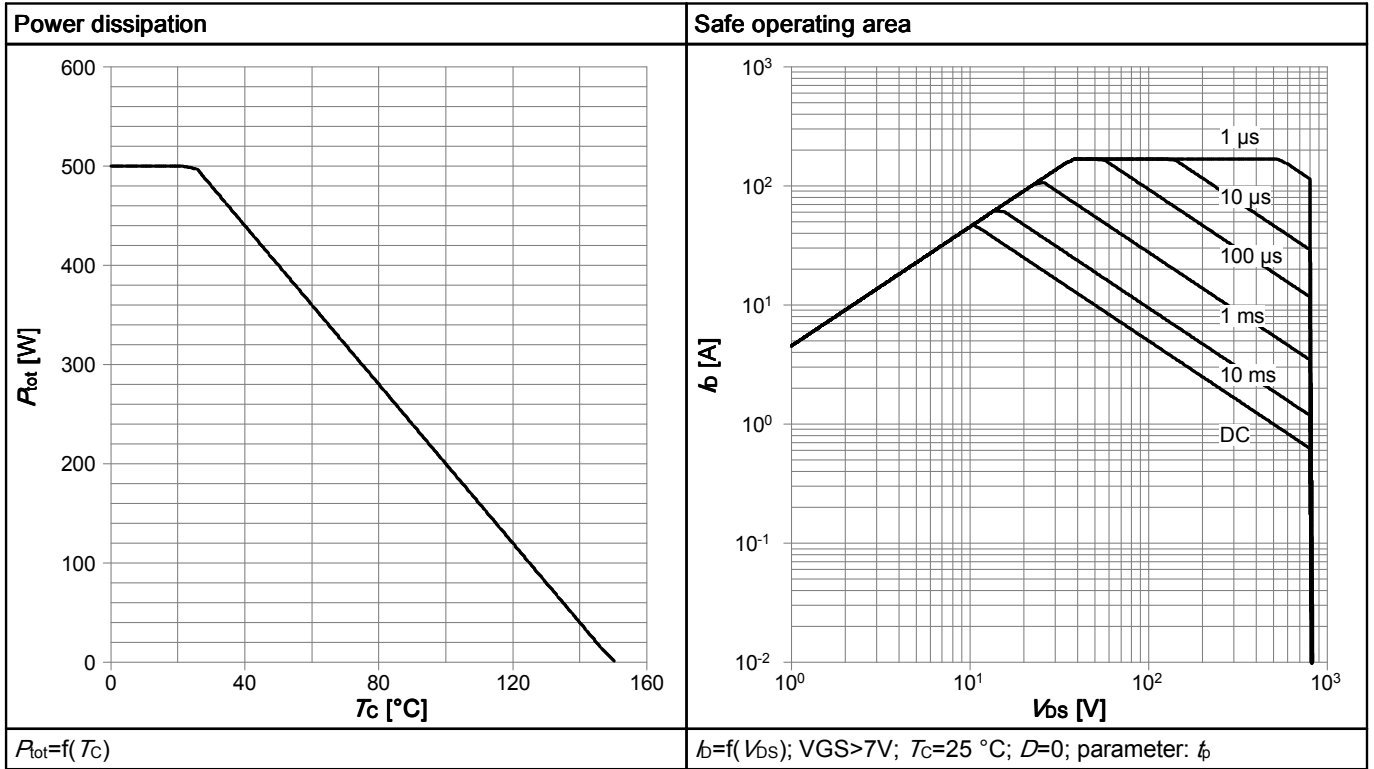


Table 9

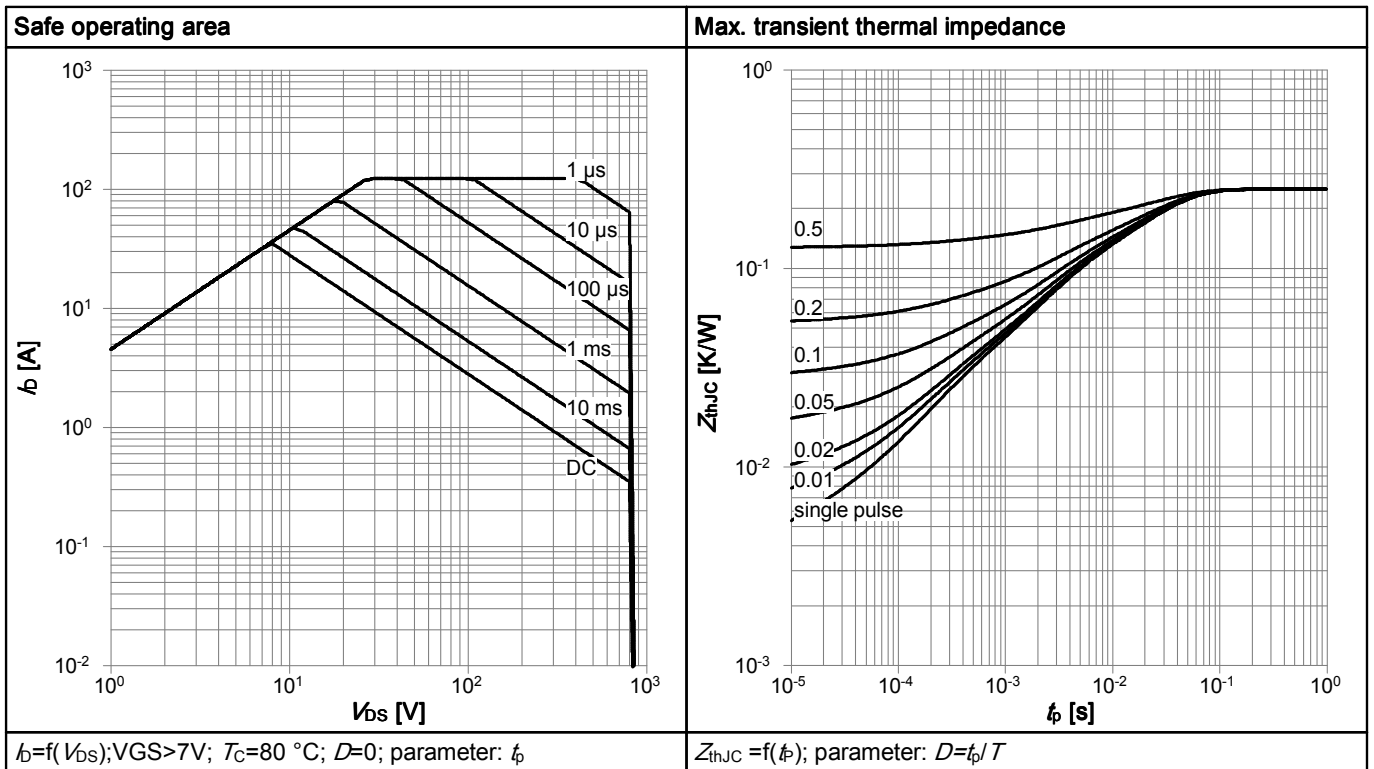




Table 10

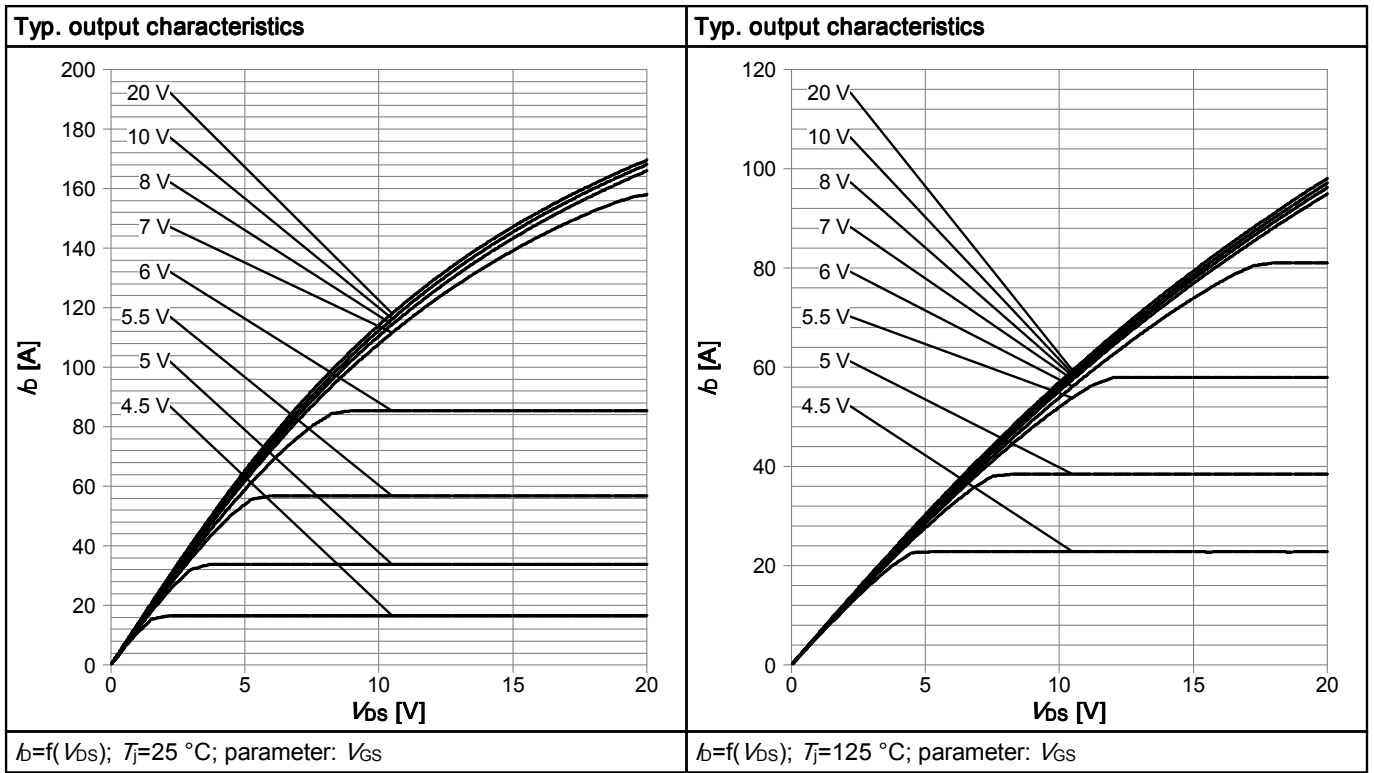


Table 11

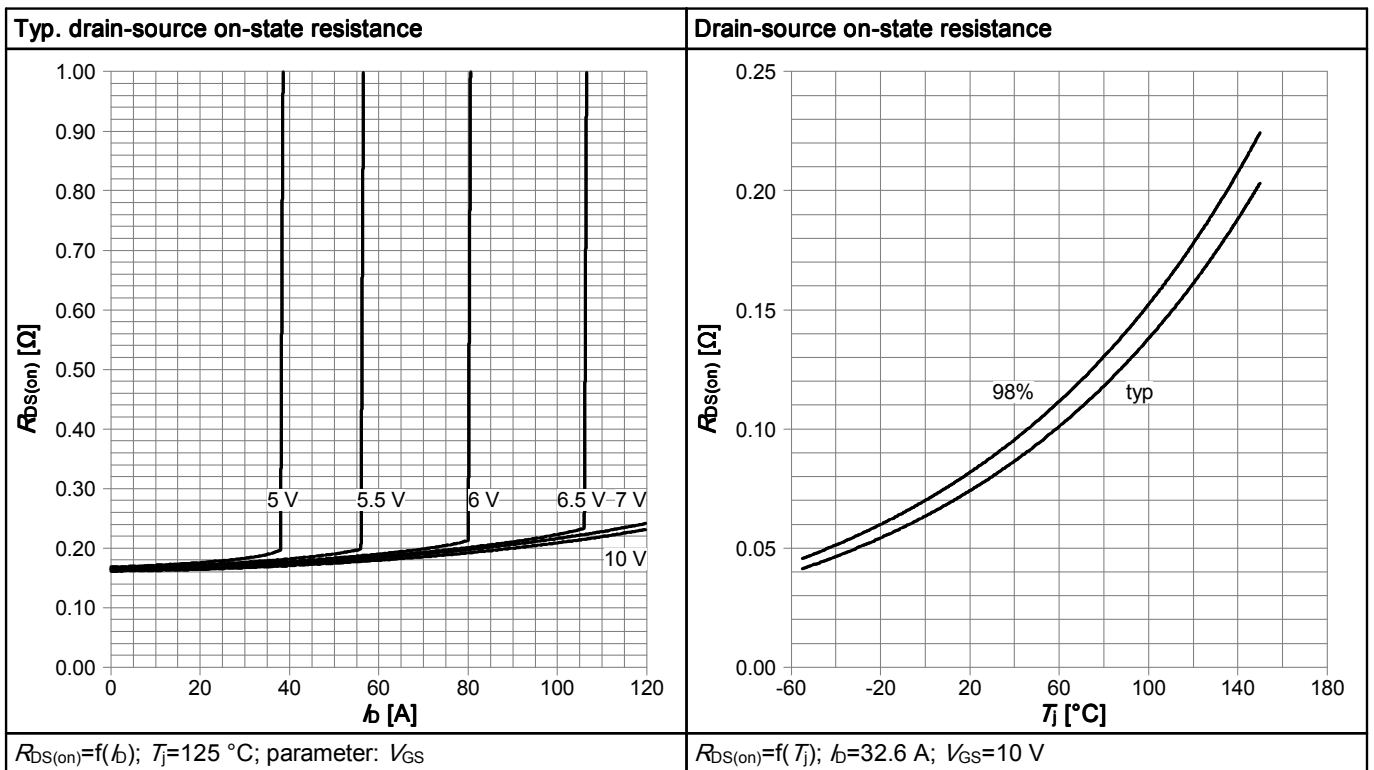


Table 12

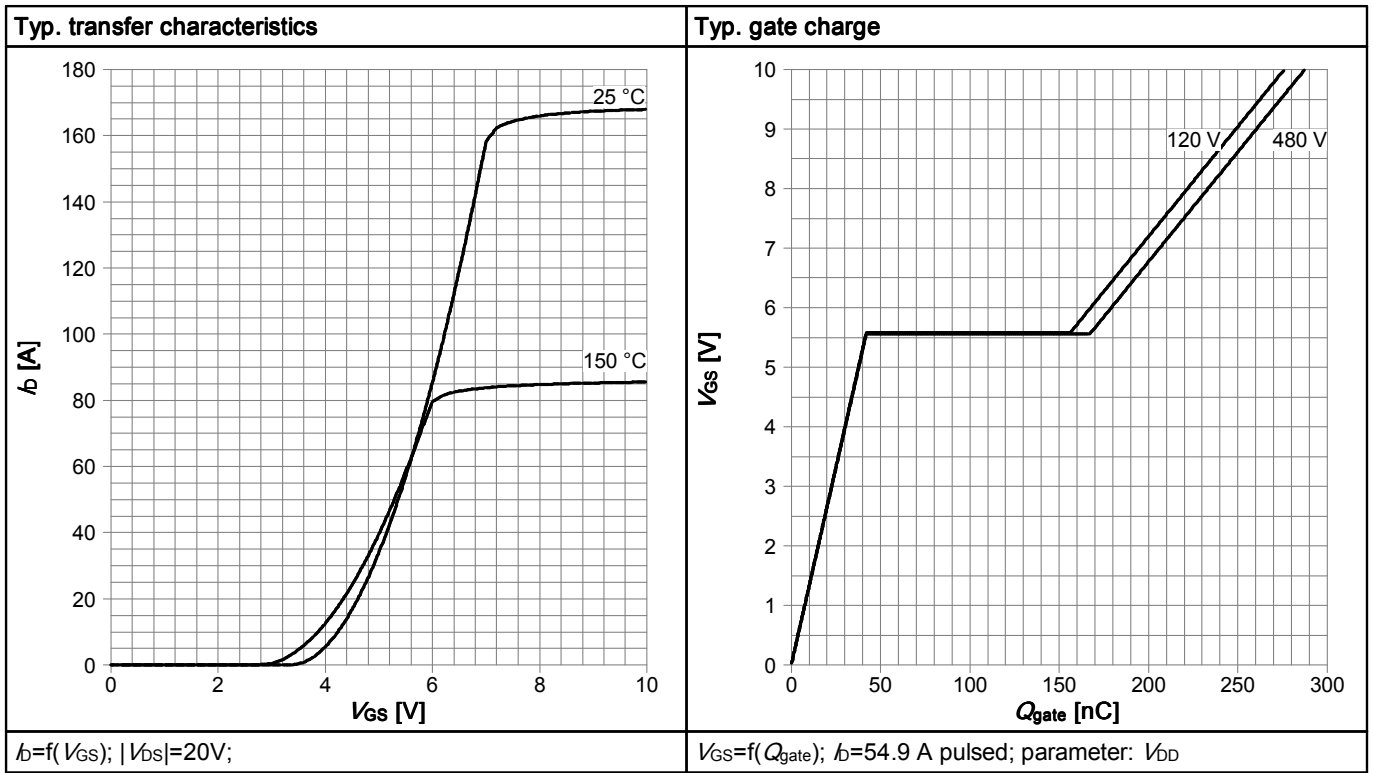
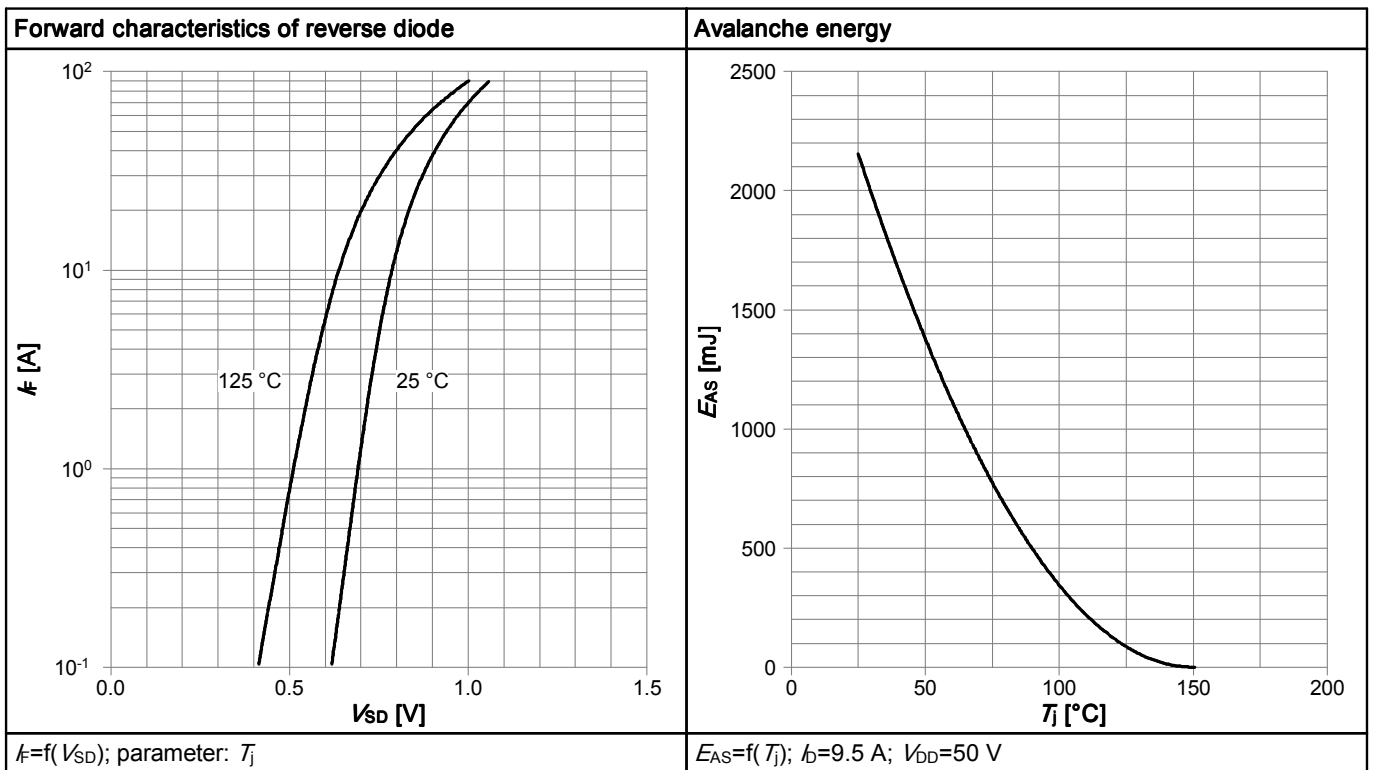
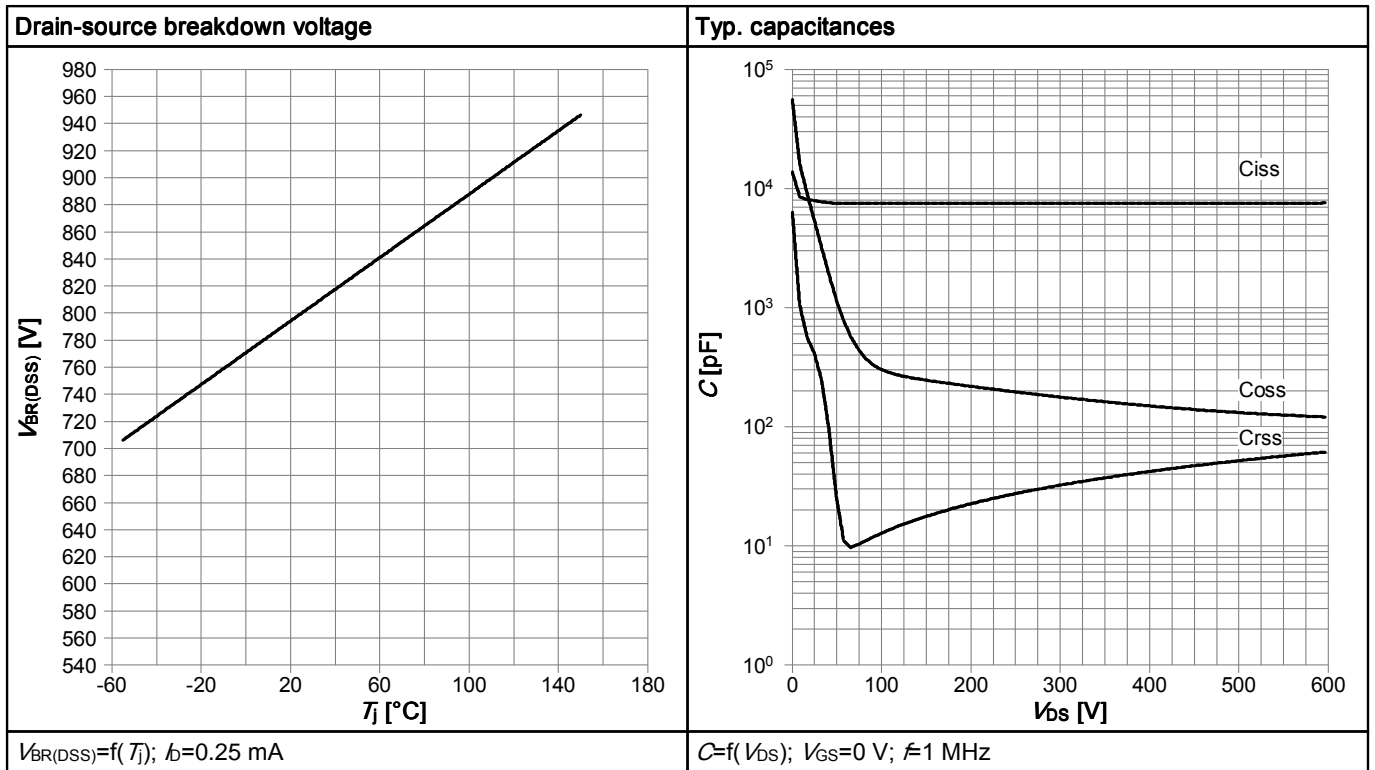


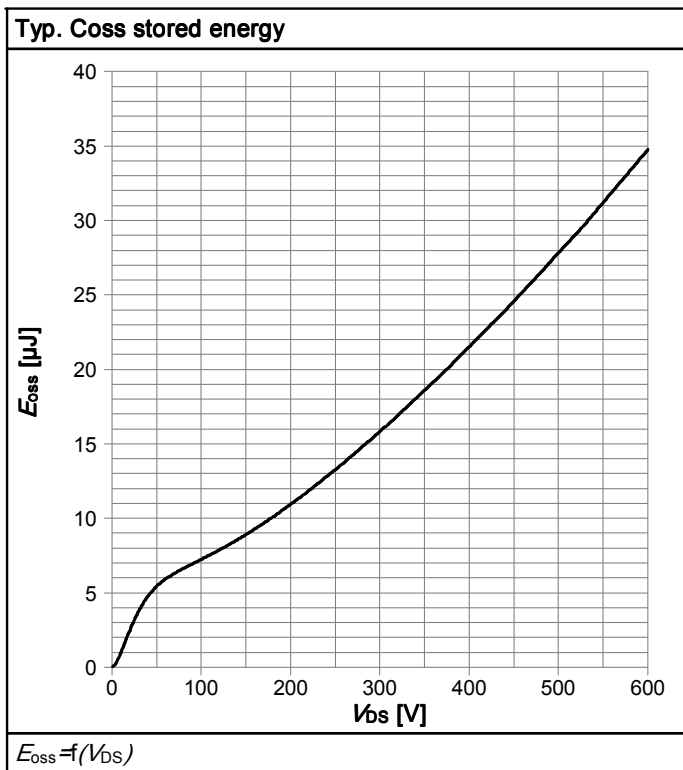
Table 13



**Table 14**

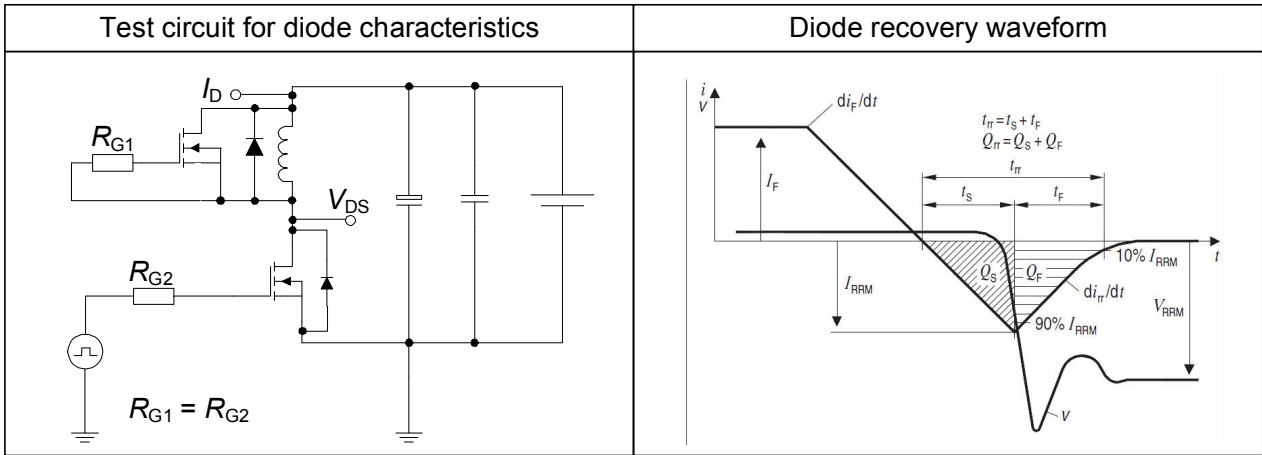


**Table 15**

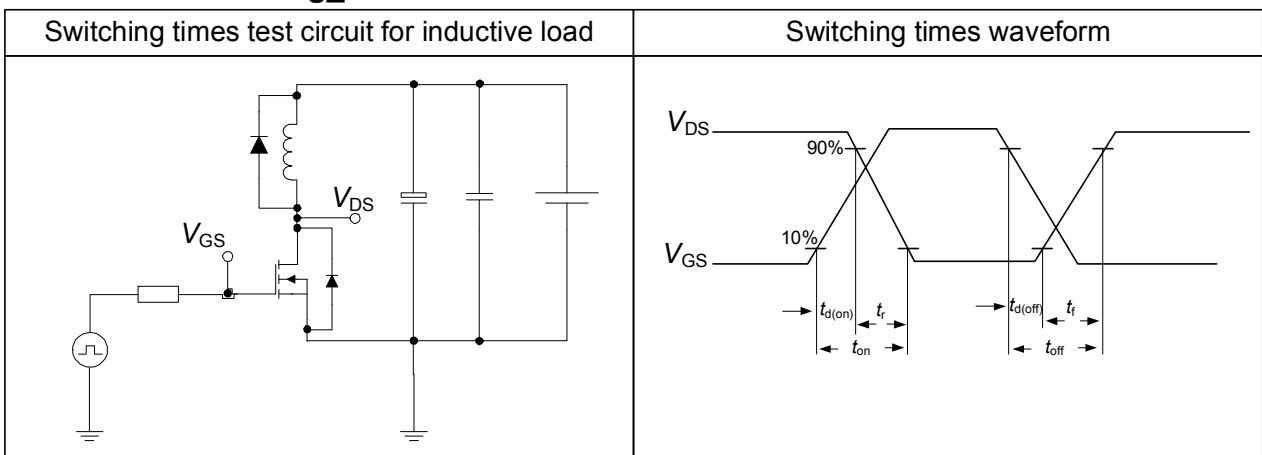


## 6 Test Circuits

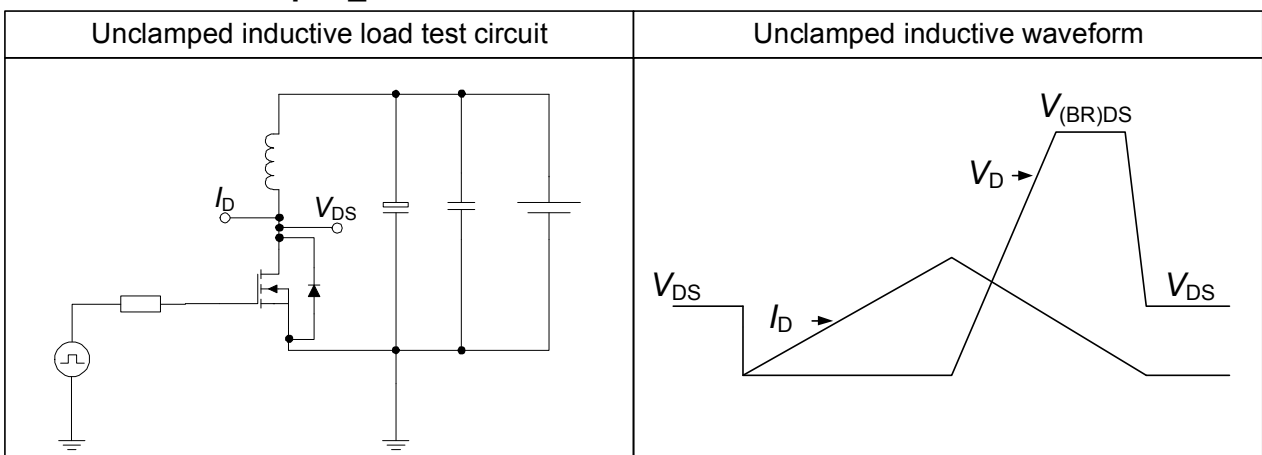
**Table 16 Diode\_characteristics**



**Table 17 Switching\_times**



**Table 18 Unclamped\_inductive**



### 7 Package Outlines

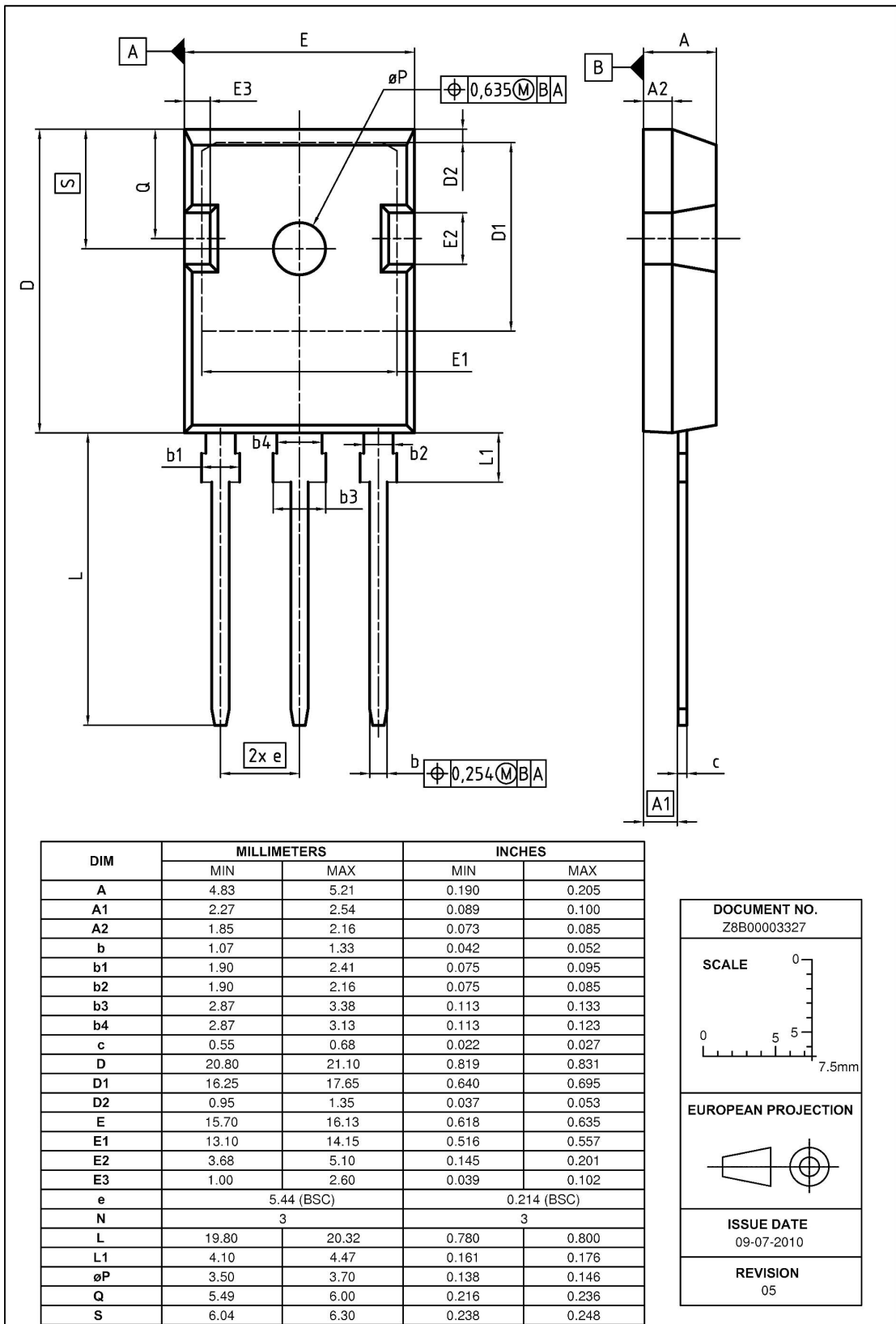


Figure 1 Outline PG-TO 247, dimensions in mm/inches

## 8 Appendix A

### Table 19 Related Links

- **IFX CoolMOS Webpage:**  
<http://www.infineon.com/cms/en/product/channel.html?channel=ff80808112ab681d0112ab6a628704d8>
- **IFX Design Tools:**  
<http://www.infineon.com/cms/en/product/promopages/designtools/index.html>

## Revision History

SPW55N80C3

Revision: 2011-10-12, Rev. 2.2

Previous Revision

Revision	Date	Subjects (major changes since last revision)
2.0	2011-09-26	release of final datasheet

### We Listen to Your Comments

Any information within this document that you feel is wrong, unclear or missing at all? Your feedback will help us to continuously improve the quality of this document. Please send your proposal (including a reference to this document) to: [erratum@infineon.com](mailto:erratum@infineon.com)

Edition 2011-08-01

Published by  
Infineon Technologies AG  
81726 München, Germany  
© 2011 Infineon Technologies AG  
All Rights Reserved.

### Legal Disclaimer

The information given in this document shall in no event be regarded as a guarantee of conditions or characteristics. With respect to any examples or hints given herein, any typical values stated herein and/or any information regarding the application of the device, Infineon Technologies hereby disclaims any and all warranties and liabilities of any kind, including without limitation, warranties of non-infringement of intellectual property rights of any third party.

### Information

For further information on technology, delivery terms and conditions and prices please contact your nearest Infineon Technologies Office ([www.infineon.com](http://www.infineon.com)).

### Warnings

Due to technical requirements, components may contain dangerous substances. For information on the types in question, please contact the nearest Infineon Technologies Office.

The Infineon Technologies component described in this Data Sheet may be used in life-support devices or systems and/or automotive, aviation and aerospace applications or systems only with the express written approval of Infineon Technologies, if a failure of such components can reasonably be expected to cause the failure of that life-support, automotive, aviation and aerospace device or system or to affect the safety or effectiveness of that device or system. Life support devices or systems are intended to be implanted in the human body or to support and/or maintain and sustain and/or protect human life. If they fail, it is reasonable to assume that the health of the user or other persons may be endangered.

# Mouser Electronics

Authorized Distributor

Click to View Pricing, Inventory, Delivery & Lifecycle Information:

[Infineon:](#)

[SPW55N80C3FKSA1](#)