

Low voltage high performance PNP power transistor

Datasheet — production data

Features

- Very low collector-emitter saturation voltage
- High current gain characteristic
- Small, thin, leadless SMD plastic package with excellent thermal behavior

Applications

- Power management
- DC-DC converters

Description

This device is an PNP transistor manufactured using new low voltage planar technology with double metal process. The result is a transistor which boasts exceptionally high gain performance coupled with very low saturation voltage.

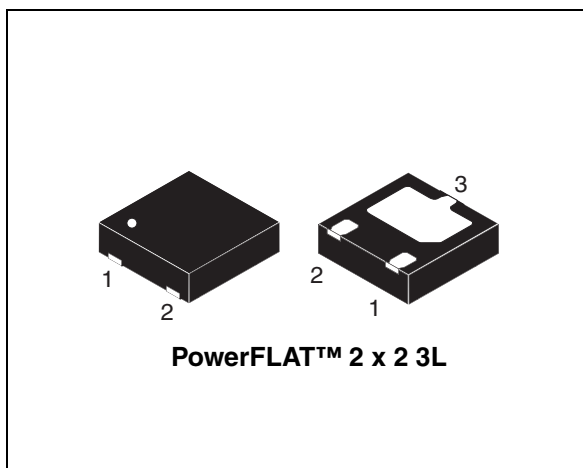

Figure 1. Internal schematic diagram

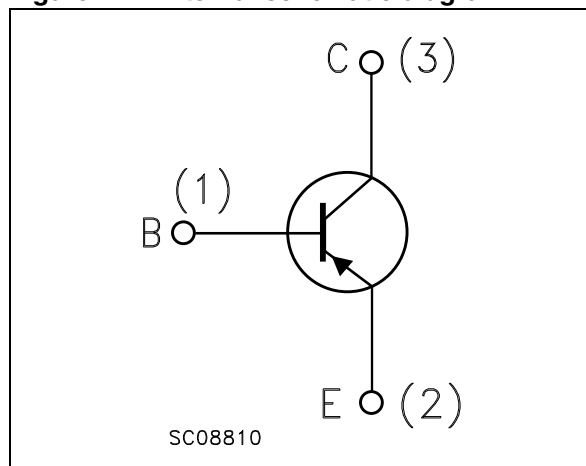

Table 1. Device summary

Order code	Marking	Package	Packaging
3STL2540	L2540	PowerFLAT™ 2 x 2	Tape and reel

1 Absolute maximum ratings

Table 2. Absolute maximum ratings

Symbol	Parameter	Value	Unit
V_{CBO}	Collector-base voltage ($I_E = 0$)	-40	V
V_{CEO}	Collector-emitter voltage ($I_B = 0$)	-40	V
V_{EBO}	Emitter-base voltage ($I_C = 0$)	-6	V
I_C	Collector current	-5	A
I_{CM}	Collector peak current ($t_P < 5$ ms)	-10	A
I_B	Base current	-0.5	A
I_{BM}	Base peak current ($t_P < 5$ ms)	-1	A
$P_{TOT}^{(1)}$	Total dissipation at $T_A = 25$ °C	1.2	W
T_{STG}	Storage temperature	-65 to 150	°C
T_J	Max. operating junction temperature	150	°C

1. Device mounted on a PCB area of 1 cm²

Table 3. Thermal data

Symbol	Parameter	Value	Unit
$R_{thJA}^{(1)}$	Thermal resistance junction-ambient max	104	°C/W
$R_{thJA}^{(2)}$	Thermal resistance junction-ambient max	75	°C/W
R_{thJC}	Thermal resistance junction-case max	45	°C/W

1. Device mounted on a PCB area of 1 cm²

2. Device mounted on a PCB area of 6 cm²

2 Electrical characteristics

$T_J = 25\text{ °C}$; unless otherwise specified.

Table 4. Electrical characteristics

Symbol	Parameter	Test conditions	Min.	Typ.	Max.	Unit
I_{CBO}	Collector cut-off current ($I_E = 0$)	$V_{CB} = -40\text{ V}$			-100	nA
I_{EBO}	Emitter cut-off current ($I_C = 0$)	$V_{EB} = -6\text{ V}$			-100	nA
$V_{BE(on)}$	Base-emitter on voltage	$V_{CE} = -2\text{ V}$ $I_C = -100\text{ mA}$		-670		mV
$V_{CE(sat)}^{(1)}$	Collector-emitter saturation voltage	$I_C = -1\text{ A}$ $I_B = -10\text{ mA}$ $I_C = -2\text{ A}$ $I_B = -100\text{ mA}$ $I_C = -5\text{ A}$ $I_B = -250\text{ mA}$		-150 -300	-200	mV
$V_{BE(sat)}^{(1)}$	Base-emitter saturation voltage	$I_C = -1\text{ A}$ $I_B = -10\text{ mA}$		800		mV
$h_{FE}^{(1)}$	DC current gain	$V_{CE} = -2\text{ V}$ $I_C = -0.5\text{ A}$ $V_{CE} = -2\text{ V}$ $I_C = -2\text{ A}$ $V_{CE} = -2\text{ V}$ $I_C = -5\text{ A}$		280 210 100		
		$V_{CE} = -0.2 \div -2\text{ V}$ $I_C = -1\text{ A}$ $T_J = -30\text{ °C} \div 150\text{ °C}$	100		900	
t_d	Resistive load Delay time	$I_C = -2\text{ A}$ $V_{CC} = -10\text{ V}$ $V_{BE(off)} = 5\text{ V}$, - $I_{B(on)} = I_{B(off)} = 200\text{ mA}$		25		ns
t_r	Rise time			140		ns
t_s	Storage time			290		ns
t_f	Fall time			60		ns
f_T	Transition frequency	$I_C = -0.1\text{ A}$ $V_{CE} = -10\text{ V}$		130		MHz

1. Pulse test: pulse duration $\leq 300\text{ }\mu\text{s}$, duty cycle $\leq 2\%$.

2.1 Electrical characteristics (curves)

Figure 2. DC current gain ($V_{CE}=-2\text{ V}$)

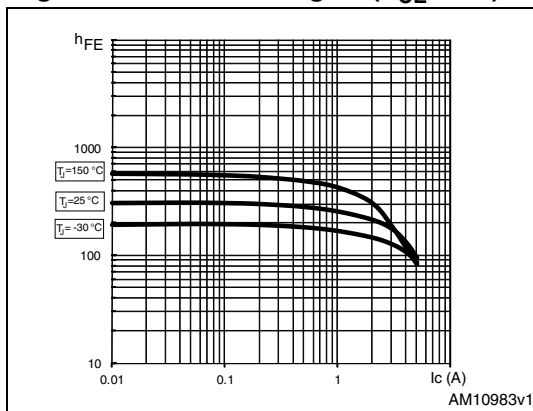

Figure 3. DC current gain ($V_{CE}=-5\text{ V}$)

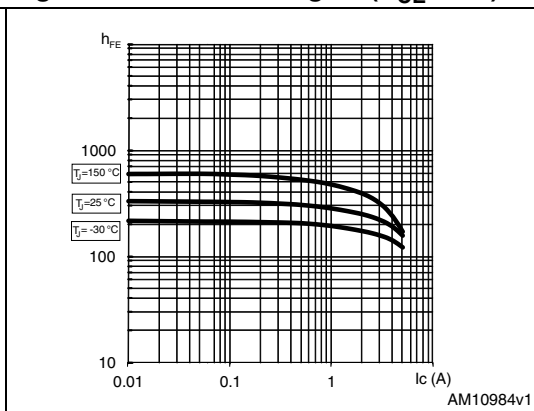

Figure 4. Collector-emitter saturation voltage (V_{CEsat} @ $h_{FE}=20$)

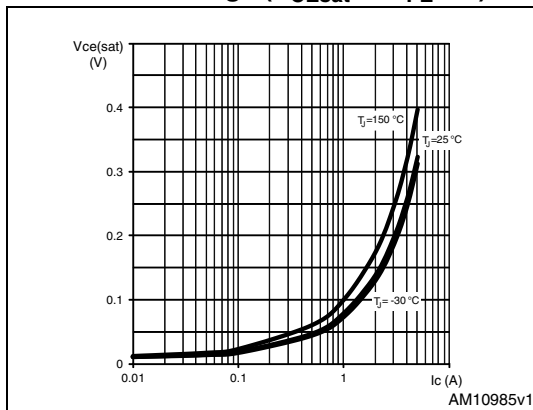

Figure 5. Collector-emitter saturation voltage (V_{CEsat} @ $h_{FE}=100$)

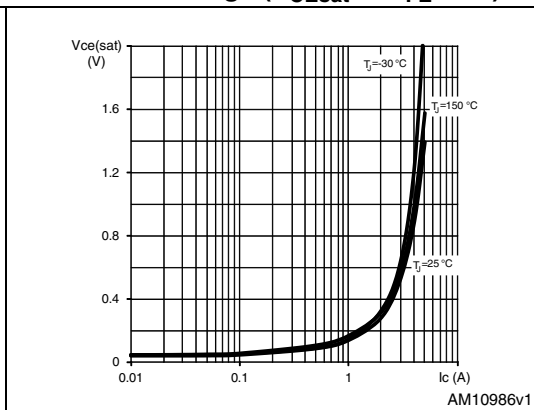

Figure 6. Base-emitter saturation voltage ($V_{be(sat)}$ @ $h_{FE}=20$)

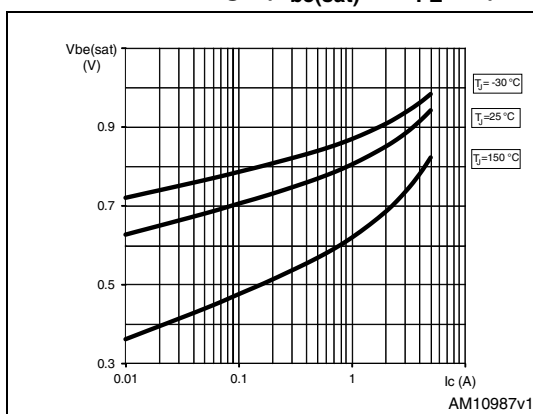

Figure 7. Base-emitter saturation voltage ($V_{be(sat)}$ @ $h_{FE}=100$)

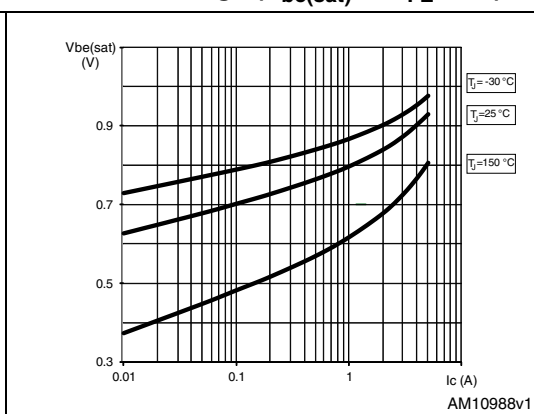

Figure 8. Resistive load switching times

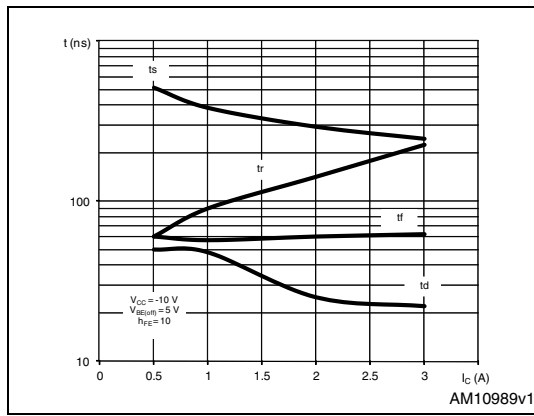
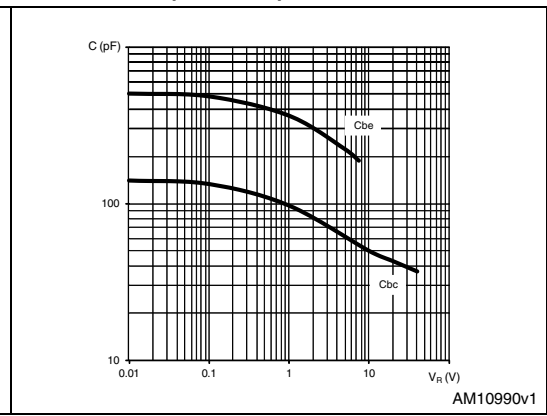

Figure 9. Capacitance curves (f=1 MHz)



3 Package mechanical data

In order to meet environmental requirements, ST offers these devices in different grades of ECOPACK[®] packages, depending on their level of environmental compliance. ECOPACK[®] specifications, grade definitions and product status are available at: www.st.com. ECOPACK[®] is an ST trademark.

Table 5. PowerFLAT™ 2 x 2 3L mechanical data

Dim.	mm.		
	Min.	Typ.	Max.
A	0.55	0.60	0.65
A1	0.00	0.02	0.05
A3		0.10	
b	0.25	0.30	0.35
D	1.90	2.00	2.10
E	1.90	2.00	2.10
e	1.20	1.30	1.40
D2	0.95	1.05	1.15
E2	1.40	1.50	1.60
H	0.20	0.25	0.30
K	0.20	0.30	0.40
L	0.35	0.40	0.45
R	0.15		

Figure 10. PowerFLAT™ 2 x 2 3L drawing

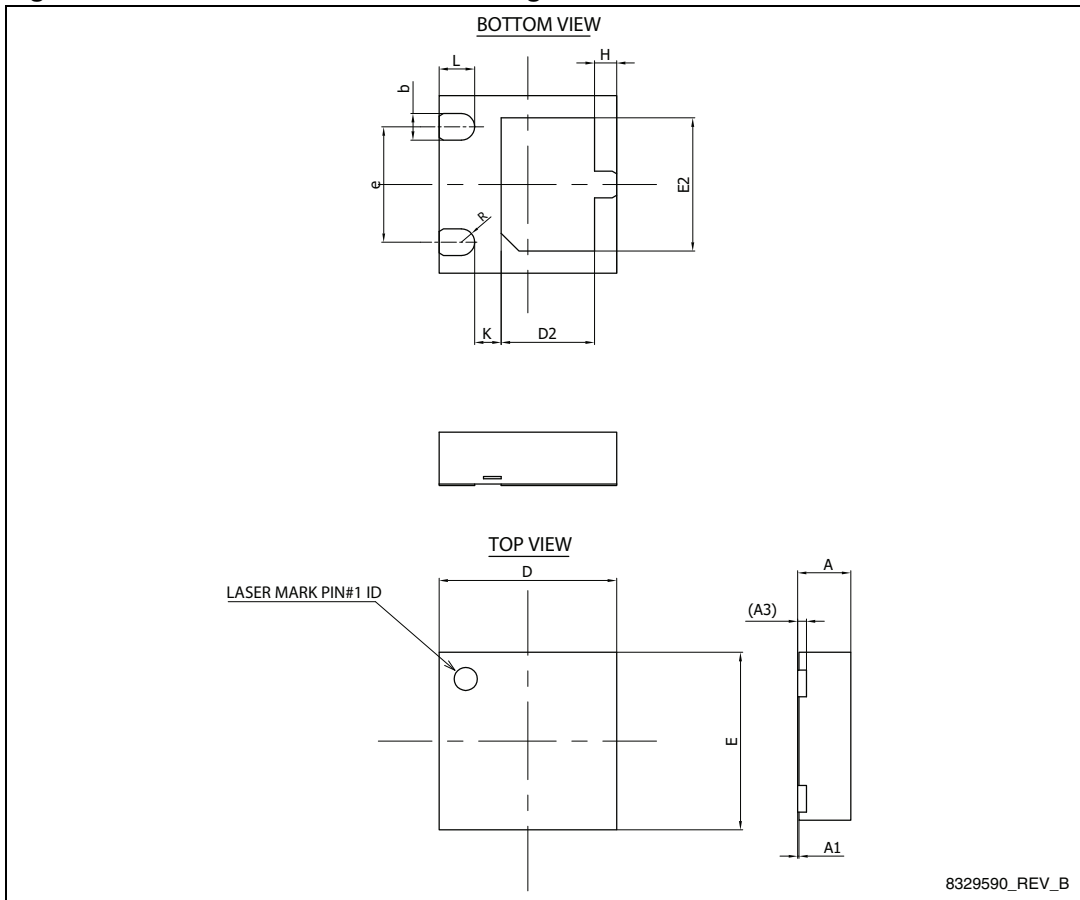

8329590_REV_B

4 Packaging mechanical data

Figure 11. PowerFLAT™ 2 x 2 3L footprint (dimension in mm.)

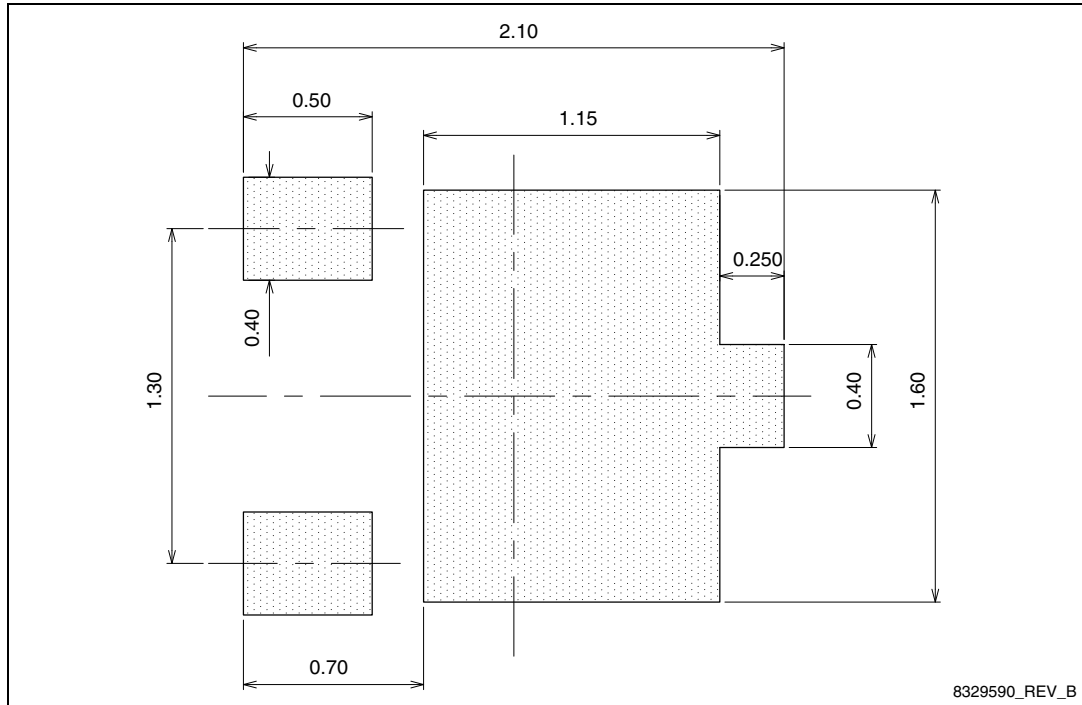

5 Revision history

Table 6. Document revision history

Date	Revision	Changes
07-Dec-2011	1	Initial release
22-May-2012	2	Document status promoted from preliminary data to production data

Please Read Carefully:

Information in this document is provided solely in connection with ST products. STMicroelectronics NV and its subsidiaries ("ST") reserve the right to make changes, corrections, modifications or improvements, to this document, and the products and services described herein at any time, without notice.

All ST products are sold pursuant to ST's terms and conditions of sale.

Purchasers are solely responsible for the choice, selection and use of the ST products and services described herein, and ST assumes no liability whatsoever relating to the choice, selection or use of the ST products and services described herein.

No license, express or implied, by estoppel or otherwise, to any intellectual property rights is granted under this document. If any part of this document refers to any third party products or services it shall not be deemed a license grant by ST for the use of such third party products or services, or any intellectual property contained therein or considered as a warranty covering the use in any manner whatsoever of such third party products or services or any intellectual property contained therein.

UNLESS OTHERWISE SET FORTH IN ST'S TERMS AND CONDITIONS OF SALE ST DISCLAIMS ANY EXPRESS OR IMPLIED WARRANTY WITH RESPECT TO THE USE AND/OR SALE OF ST PRODUCTS INCLUDING WITHOUT LIMITATION IMPLIED WARRANTIES OF MERCHANTABILITY, FITNESS FOR A PARTICULAR PURPOSE (AND THEIR EQUIVALENTS UNDER THE LAWS OF ANY JURISDICTION), OR INFRINGEMENT OF ANY PATENT, COPYRIGHT OR OTHER INTELLECTUAL PROPERTY RIGHT.

UNLESS EXPRESSLY APPROVED IN WRITING BY TWO AUTHORIZED ST REPRESENTATIVES, ST PRODUCTS ARE NOT RECOMMENDED, AUTHORIZED OR WARRANTED FOR USE IN MILITARY, AIR CRAFT, SPACE, LIFE SAVING, OR LIFE SUSTAINING APPLICATIONS, NOR IN PRODUCTS OR SYSTEMS WHERE FAILURE OR MALFUNCTION MAY RESULT IN PERSONAL INJURY, DEATH, OR SEVERE PROPERTY OR ENVIRONMENTAL DAMAGE. ST PRODUCTS WHICH ARE NOT SPECIFIED AS "AUTOMOTIVE GRADE" MAY ONLY BE USED IN AUTOMOTIVE APPLICATIONS AT USER'S OWN RISK.

Resale of ST products with provisions different from the statements and/or technical features set forth in this document shall immediately void any warranty granted by ST for the ST product or service described herein and shall not create or extend in any manner whatsoever, any liability of ST.

ST and the ST logo are trademarks or registered trademarks of ST in various countries.

Information in this document supersedes and replaces all information previously supplied.

The ST logo is a registered trademark of STMicroelectronics. All other names are the property of their respective owners.

© 2012 STMicroelectronics - All rights reserved

STMicroelectronics group of companies

Australia - Belgium - Brazil - Canada - China - Czech Republic - Finland - France - Germany - Hong Kong - India - Israel - Italy - Japan - Malaysia - Malta - Morocco - Philippines - Singapore - Spain - Sweden - Switzerland - United Kingdom - United States of America

www.st.com



Mouser Electronics

Authorized Distributor

Click to View Pricing, Inventory, Delivery & Lifecycle Information:

[STMicroelectronics:](#)

[3STL2540](#)