

High junction temperature Transil™

Datasheet - production data

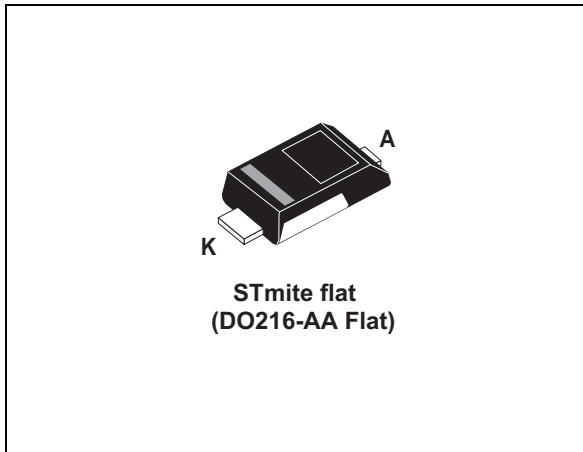

Description

The SMM4F Transil series has been designed to protect sensitive equipment against electro-static discharges according to IEC 61000-4-2, MIL STD 883 Method 3015, and electrical over stress such as IEC 61000-4-4 and 5. They are generally for surges below 400 W 10/1000 μ s.

This planar technology makes it compatible with high-end equipment and SMPS where low leakage current and high junction temperature are required to provide reliability and stability over time. Their low clamping voltages provide a better safety margin to protect sensitive circuits with extended life time expectancy.

Packaged in STmite flat, this minimizes PCB space consumption (footprint in accordance with IPC 7531 standard). Transil is a trademark of STMicroelectronics.

Features

- Typical peak pulse power:
 - 400 W (10/1000 μ s)
 - 2.4 kW (8/20 μ s)
- Stand off voltage range: from 5 V to 33 V
- Unidirectional types
- Low leakage current:
 - 0.2 μ A at 25 °C
 - 1 μ A at 85 °C
- Operating T_j max: 175 °C
- JEDEC registered package outline
- RoHS package
- Halogen free molding compound

Complies with the following standards

- IEC 61000-4-2 level 4:
 - 15 kV (air discharge)
 - 8 kV (contact discharge)
- MIL STD 883G-Method 3015-7: class3
 - 25 kV (human body model)

1 Characteristics

Table 1. Absolute ratings ($T_{amb} = 25\text{ °C}$)

Symbol	Parameter		Value	Unit
V_{PP}	Peak pulse voltage (IEC 61000-4-2 contact discharge)		30	kV
P_{PP}	Peak pulse power dissipation ⁽¹⁾	T_j initial = T_{amb}	400	W
P	Power dissipation on infinite heatsink	$T_{amb} = 125\text{ °C}$	2.5	W
I_{FSM}	Non repetitive surge peak forward current for unidirectional types	$t_p = 10\text{ ms}$ T_j initial = T_{amb}	30	A
T_{stg}	Storage temperature range		-65 to +175	°C
T_j	Operating junction temperature range		-55 to +175	°C
T_L	Maximum lead temperature for soldering during 10 s		260	°C

1. For a surge greater than the maximum values, the diode will fail in short-circuit.

Table 2. Thermal resistances

Symbol	Parameter	Value	Unit
$R_{th(j-l)}$	Junction to leads	20	°C/W
$R_{th(j-a)}$	Junction to ambient on PCB with recommended pad layout	250	

Table 3. Electrical characteristics - parameter definitions ($T_{amb} = 25\text{ °C}$)

Symbol	Parameter
V_{RM}	Stand-off voltage
V_{BR}	Breakdown voltage
I_R	Breakdown current
V_{CL}	Clamping voltage
I_{RM}	Leakage current @ V_{RM}
I_{PP}	Peak pulse current
αT	Voltage temperature coefficient
V_F	Forward voltage drop
R_D	Dynamic resistance

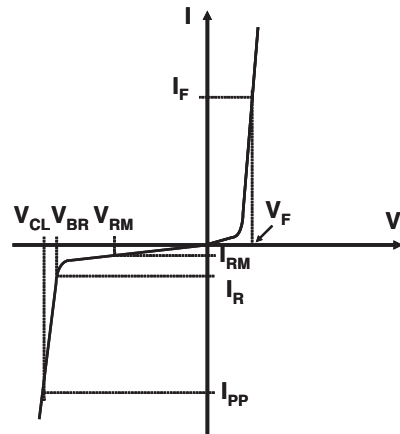

Table 4. Electrical characteristics - parameter values (T_{amb} = 25 °C)

Type	I _{RM} max@V _{RM}		V _{BR} @I _R ⁽¹⁾				V _{CL} @I _{PP} 10/1000 μs		R _D ⁽²⁾ 10/1000 μs		V _{CL} @I _{PP} 8/20 μs		R _D ⁽²⁾ 8/20 μs		αT ⁽³⁾
	25 °C	85 °C	min	typ	max	max		max		max				max	
	μA	V	V			mA	V	A	Ω	V	A	Ω	10-4/°C		
SMM4F5.0A	10	50	5.0	6.46	6.80	7.14	10	9.2	43.5	0.047	13.4	174	0.04	5.7	
SMM4F6.0A	10	50	6.0	6.65	7.00	7.35	10	10.3	38.8	0.076	13.7	170	0.04	5.9	
SMM4F6.5A	10	50	6.5	7.13	7.50	7.88	10	11.2	37.5	0.093	14.5	160	0.04	6.1	
SMM4F8.5A	10	50	8.5	9.5	10.0	10.5	1	14.4	27.7	0.141	19.5	124	0.07	7.3	
SMM4F10A	0.2	1	10	11.4	12.0	12.6	1	17.0	23.5	0.187	21.7	106	0.09	7.8	
SMM4F12A	0.2	1	12	13.3	14.0	14.7	1	19.9	20.1	0.259	25.3	91	0.12	8.3	
SMM4F13A	0.2	1	13	14.3	15.0	15.8	1	21.5	18.6	0.309	27.2	85	0.13	8.4	
SMM4F15A	0.2	1	15	17.1	18.0	18.9	1	24.4	16.4	0.335	32.5	71	0.19	8.8	
SMM4F18A	0.2	1	18	20.9	22.0	23.1	1	29.2	14.0	0.436	39.3	59	0.27	9.2	
SMM4F20A	0.2	1	20	22.8	24.0	25.2	1	32.4	12.0	0.600	42.8	54	0.33	9.4	
SMM4F24A	0.2	1	24	26.6	28.01	29.4	1	38.9	9.5	1.00	50	46	0.47	9.6	
SMM4F26A	0.2	1	26	28.5	30.0	31.5	1	42.1	9.0	1.18	53.5	43	0.51	9.7	
SMM4F28A	0.2	1	28	31.4	33.0	34.7	1	45.4	8.0	1.34	59.0	39	0.62	9.8	
SMM4F33A	0.2	1	33	37.1	39.0	41.0	1	53.3	7.0	1.76	69.7	33	0.87	10.0	

1. Pulse test: t_p <50ms.
2. To calculate maximum clamping voltage at other surge currents, use the following formula V_{CLmax} = R_D × I_{PP} + V_{BRmax}
3. To calculate V_{BR} versus junction temperature, use the following formula: V_{BR} @ T_j = V_{BR} @ 25 °C × (1 + αT × (T_j - 25))

Figure 1. Definition of I_{PP} pulse

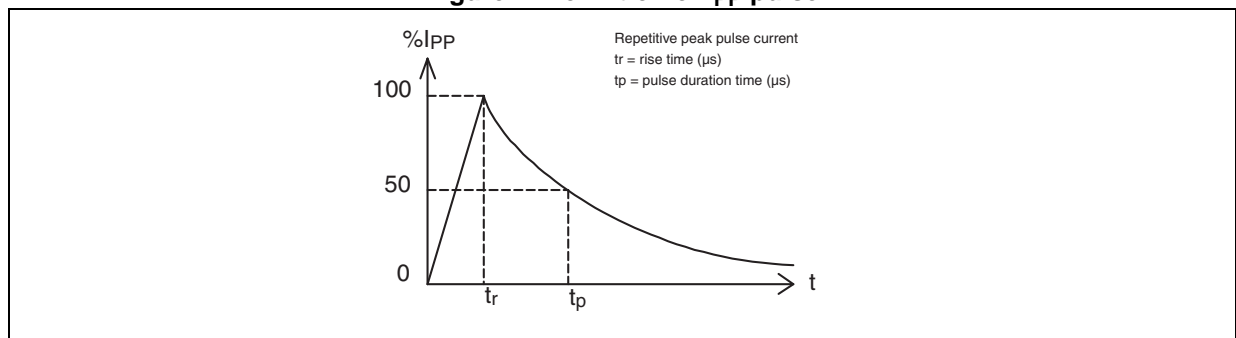

Figure 2. Peak power dissipation versus initial junction temperature

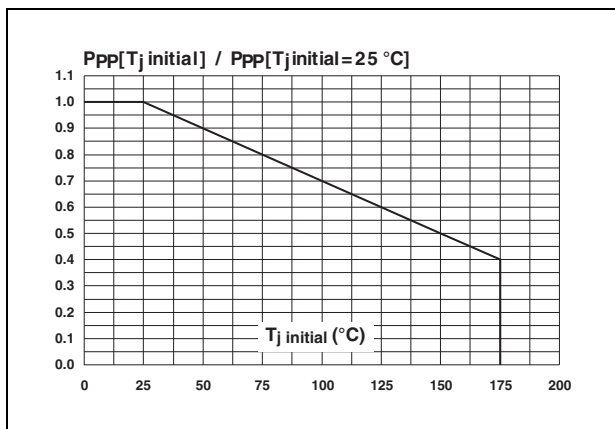

Figure 3. Peak pulse power versus exponential pulse duration (T_{j initial} = 25 °C)

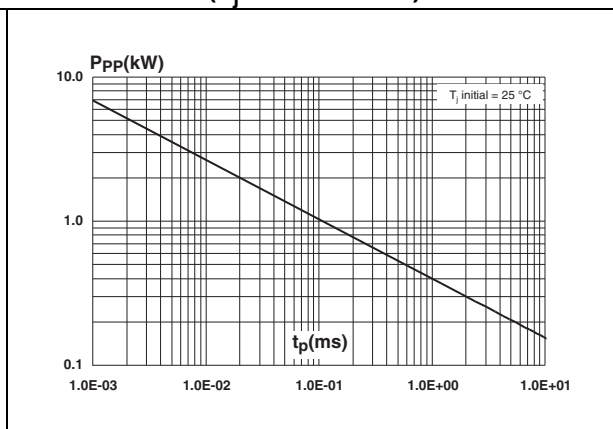

Figure 4. Clamping voltage versus peak pulse current (exponential waveform, maximum values)

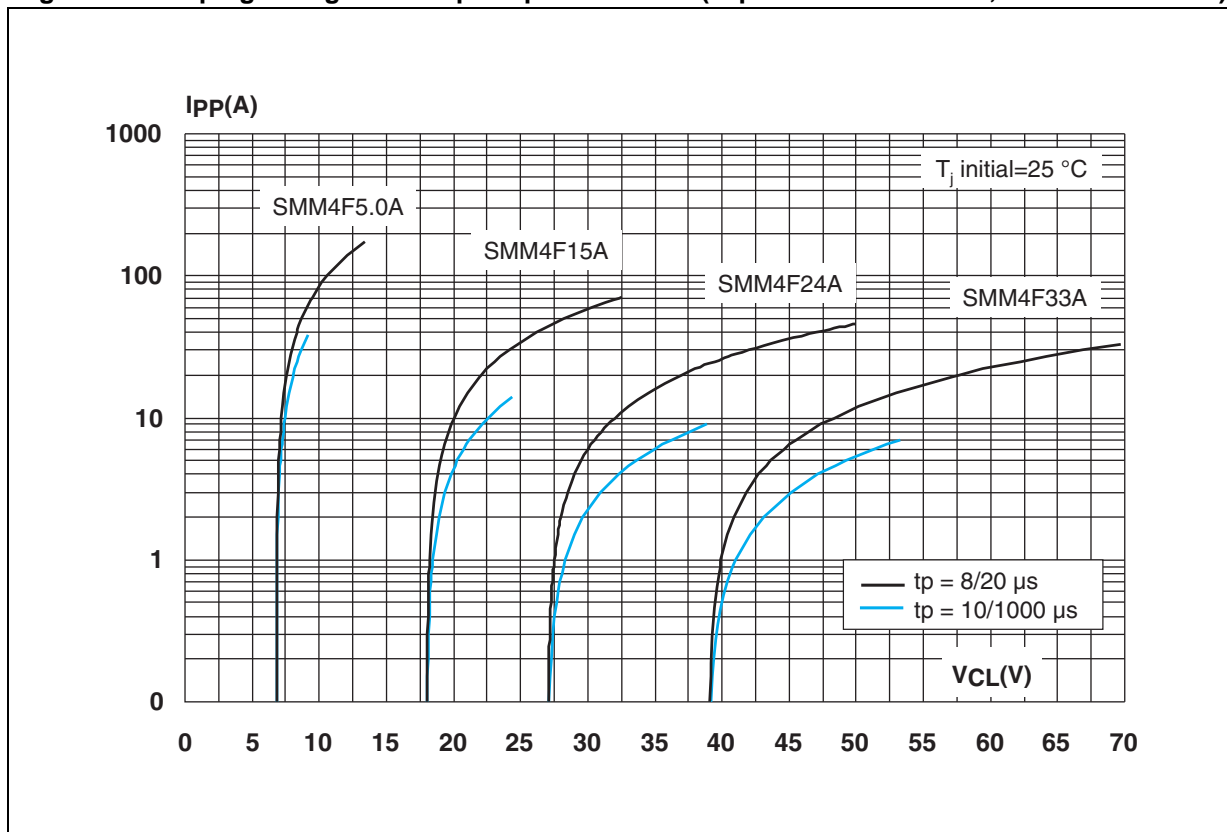

Figure 5. Junction capacitance versus reverse applied voltage (typical values)

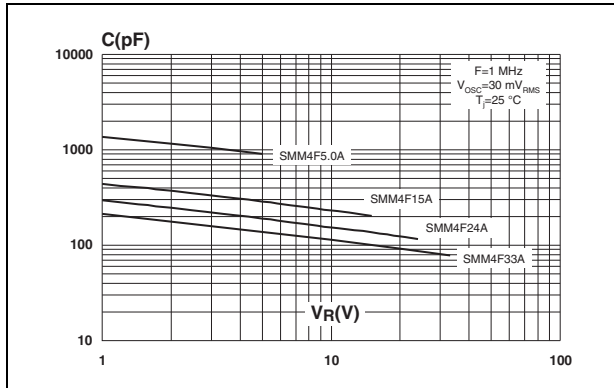

Figure 6. Peak forward voltage drop versus peak forward current (typical values)

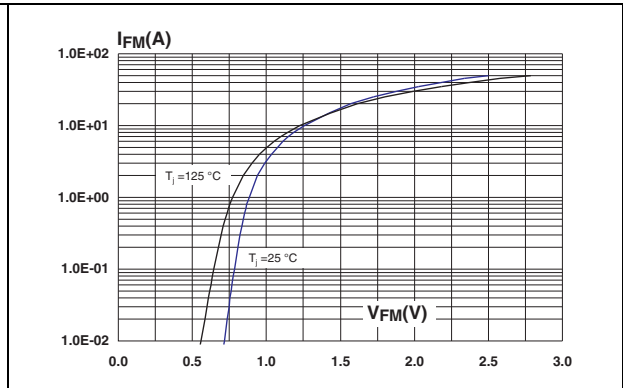

Figure 7. Relative variation of thermal impedance junction to ambient versus pulse duration (printed circuit board FR4, $S_{Cu} = 1$ cm²)

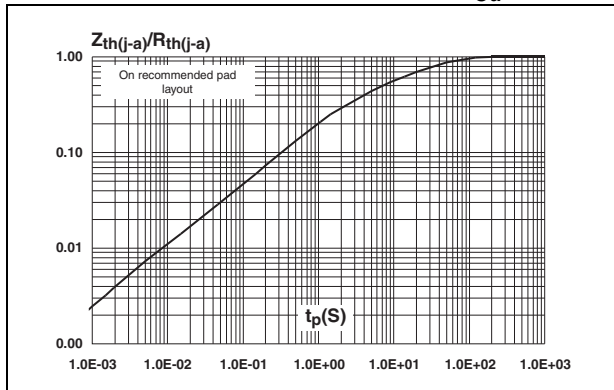

Figure 8. Thermal resistance junction to ambient versus copper surface under each lead (printed circuit board FR4, $e_{Cu} = 35$ μm)

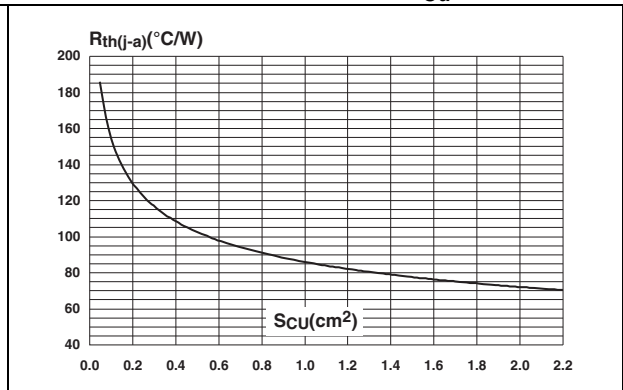
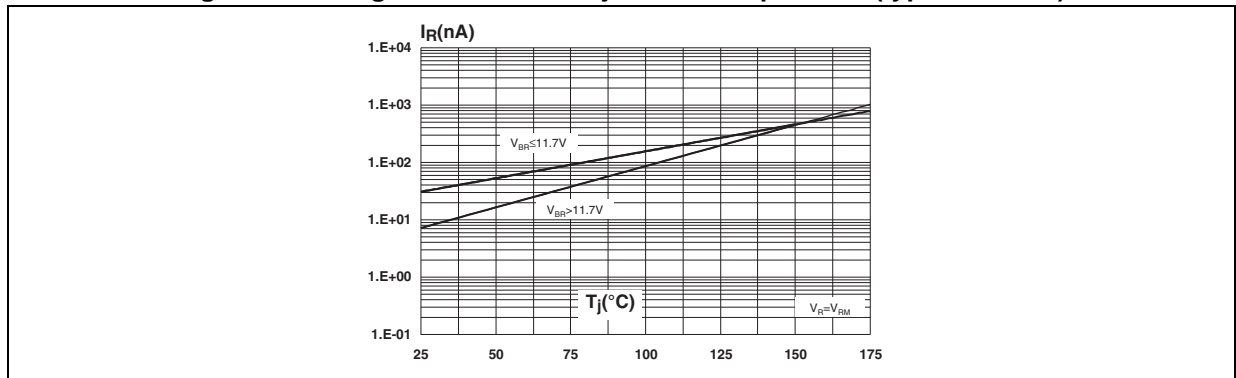
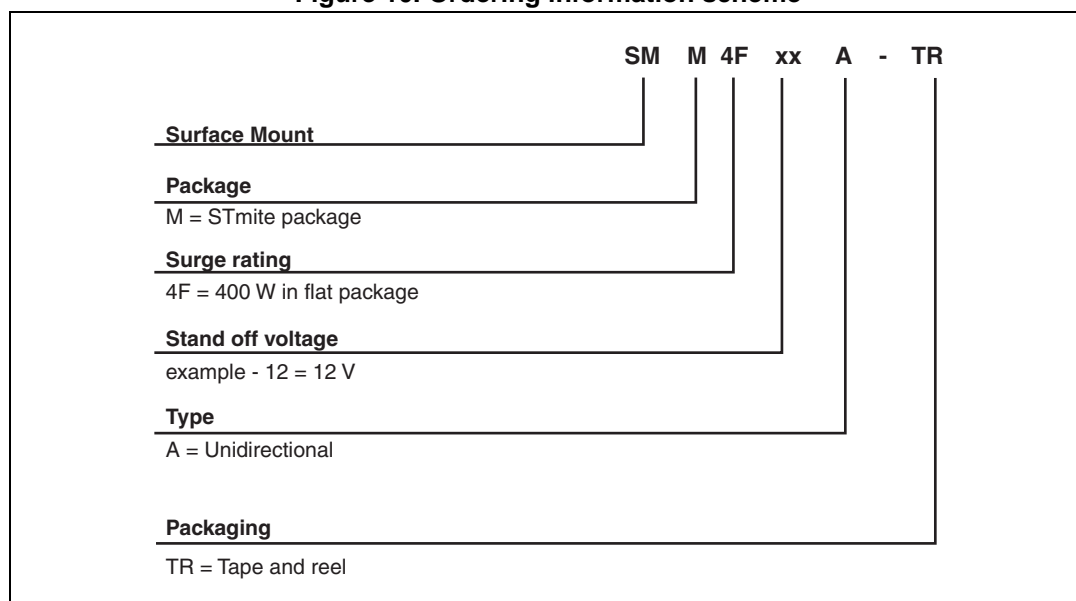

Figure 9. Leakage current versus junction temperature (typical values)



2 Ordering information scheme

Figure 10. Ordering information scheme



3 Package information

- Case: JEDEC DO216-AA Flat molded plastic over Planar junction
- Terminals: Solder plated, solderable per MIL-STD-750, Method 2026
- Polarity: For unidirectional types the band indicates cathode.
- Flammability: Epoxy is rated UL94V-0
- RoHS package

In order to meet environmental requirements, ST offers these devices in different grades of ECOPACK[®] packages, depending on their level of environmental compliance. ECOPACK[®] specifications, grade definitions and product status are available at: www.st.com. ECOPACK[®] is an ST trademark.

Table 5. STmite flat dimensions

Ref.	Dimensions					
	Millimeters			Inches		
	Min.	Typ.	Max.	Min.	Typ.	Max.
A	0.80	0.85	0.95	0.031	0.033	0.037
b	0.40	0.55	0.65	0.016	0.022	0.026
b2	0.70	0.85	1.00	0.027	0.033	0.039
c	0.10	0.15	0.25	0.004	0.006	0.009
D	1.75	1.90	2.05	0.069	0.075	0.081
E	3.60	3.80	3.90	0.142	0.150	0.154
E1	2.80	2.95	3.10	0.110	0.116	0.122
L	0.50	0.55	0.80	0.020	0.022	0.031
L1	2.10	2.40	2.60	0.083	0.094	0.102
L2	0.45	0.60	0.75	0.018	0.024	0.030
L3	0.20	0.35	0.50	0.008	0.014	0.020

Figure 11. STmite flat footprint dimensions

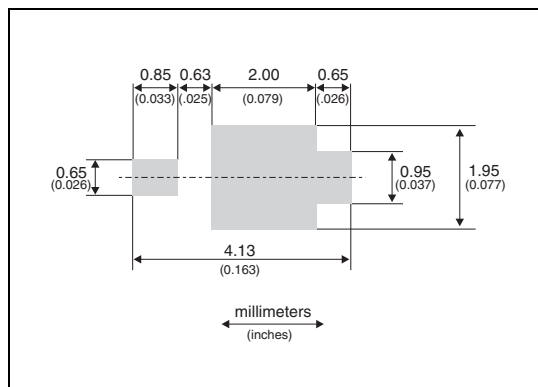

Figure 12. Marking information

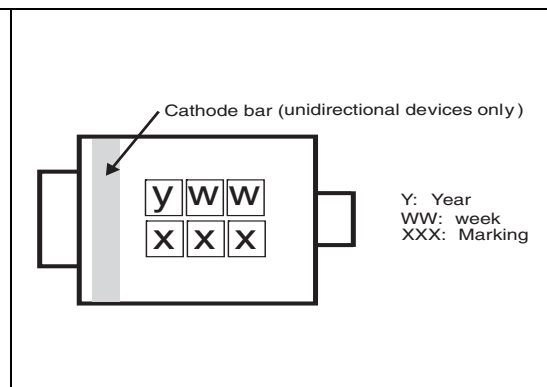

Table 6. Marking

Type	Marking
SMM4F5.0A-TR	4UA
SMM4F6.0A-TR	4UB
SMM4F6.5A-TR	4UC
SMM4F8.5A-TR	4UD
SMM4F10A-TR	4UE
SMM4F12A-TR	4UF
SMM4F13A-TR	4UG
SMM4F15A-TR	4UH
SMM4F18A-TR	4UJ
SMM4F20A-TR	4UK
SMM4F24A-TR	4UM
SMM4F26A-TR	4UN
SMM4F28A-TR	4UO
SMM4F33A-TR	4UQ

4 Ordering information

Table 7. Ordering information

Order code ⁽¹⁾	Marking	Package	Weight	Base qty	Delivery mode
SMM4FxxA-TR	See Table 6 .	STmite flat	16.7 mg	12000	Tape and reel

1. xx indicates stand-off voltage

5 Revision history

Table 8. Document revision history

Date	Revision	Changes
29-Nov-2007	1	First issue.
19-Dec-2007	2	Updated I_{PP} and R_D parameters in columns 10 and 11 of Table 4 .
20-Aug-2014	3	Updated package name.

IMPORTANT NOTICE – PLEASE READ CAREFULLY

STMicroelectronics NV and its subsidiaries ("ST") reserve the right to make changes, corrections, enhancements, modifications, and improvements to ST products and/or to this document at any time without notice. Purchasers should obtain the latest relevant information on ST products before placing orders. ST products are sold pursuant to ST's terms and conditions of sale in place at the time of order acknowledgement.

Purchasers are solely responsible for the choice, selection, and use of ST products and ST assumes no liability for application assistance or the design of Purchasers' products.

No license, express or implied, to any intellectual property right is granted by ST herein.

Resale of ST products with provisions different from the information set forth herein shall void any warranty granted by ST for such product.

ST and the ST logo are trademarks of ST. All other product or service names are the property of their respective owners.

Information in this document supersedes and replaces information previously supplied in any prior versions of this document.

© 2014 STMicroelectronics – All rights reserved

Mouser Electronics

Authorized Distributor

Click to View Pricing, Inventory, Delivery & Lifecycle Information:

[STMicroelectronics:](#)

[SMM4F5.0A-TR](#) [SMM4F6.0A-TR](#) [SMM4F6.5A-TR](#) [SMM4F8.5A-TR](#)