

Low forward voltage Transil™, transient voltage suppressor

Datasheet – production data

Features

- Strong ESD and EOS protection
- Very low clamping factor V_{CL}/V_{BR}
- Unidirectional device
- Fast response time
- Very thin package
- Very small PCB area
- RoHS compliant

Complies with the following standards:

- IEC 61000-4-2 level 4
 - ±15 kV (air discharge)
 - ±8 kV (contact discharge)

Description

The LFTVS18-1F3 is a single line diode designed specifically for the protection of integrated circuits in portable equipment and miniaturized electronics devices subject to ESD and EOS transient overvoltages.

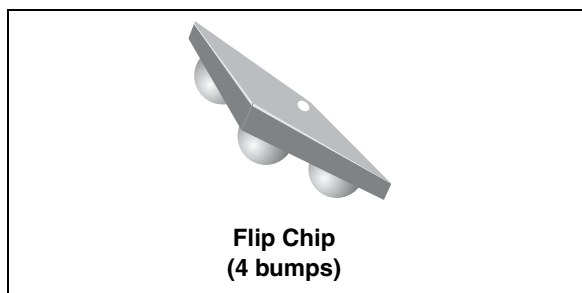

Figure 1. Pin configuration (bump side)

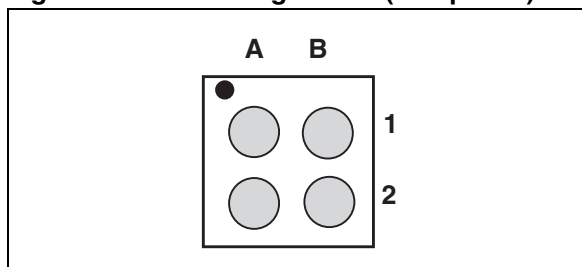
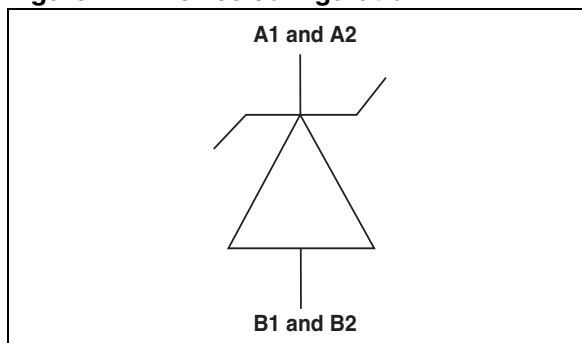

Figure 2. Device configuration



TM: Transil is a trademark of STMicroelectronics

1 Characteristics

Table 1. Absolute maximum ratings ($T_{amb} = 25\text{ }^{\circ}\text{C}$)

Symbol	Parameter	Test condition	Value	Unit
P_{PP}	Peak pulse power dissipation (8/20 μs pulse)	T_j initial = T_{amb}	350	W
I_{FSM}	Non repetitive surge peak forward current	$t_p = 10\text{ ms}$, T_j initial = T_{amb}	5	A
T_j	Maximum operating junction temperature		125	$^{\circ}\text{C}$
T_{stg}	Storage temperature range		-55 to +150	$^{\circ}\text{C}$

Figure 3. Electrical characteristics - definitions

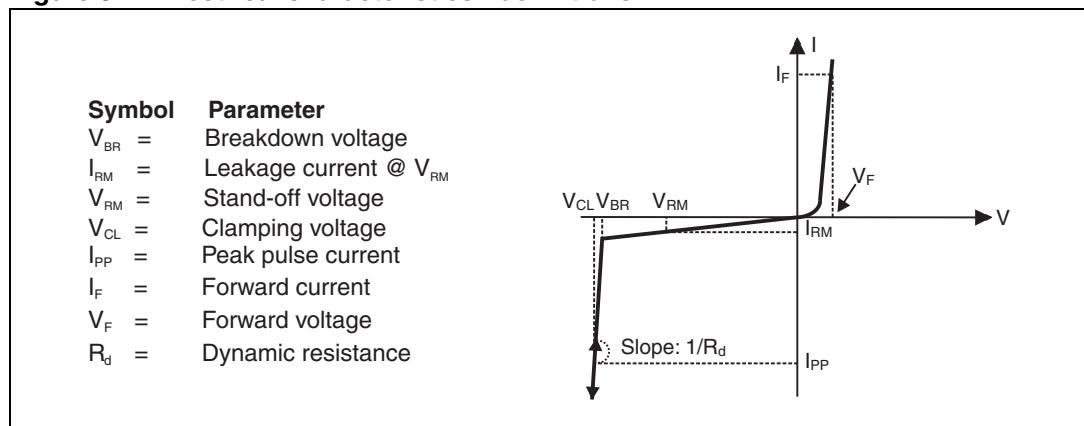

Table 2. Electrical characteristics - values ($T_{amb} = 25\text{ }^{\circ}\text{C}$)

Symbol	Test conditions	Min.	Typ.	Max.	Unit
V_{BR}	$I_R = 1\text{ mA}$	16			V
I_{RM}	$V_{RM} = 12\text{ V}$			250	nA
V_{CL}	$I_{PP} = 1\text{ A}^{(1)}$			19	V
V_F	$I_F = 850\text{ mA}$			1.3	V
C_{line}	$V_R = 0\text{ V}$, $V_{OSC} = 30\text{ mV}$, $F = 1\text{ MHz}$		175		pF

1. 8 / 20 μs pulse waveform

Figure 4. Peak pulse power versus initial junction temperature (pulse 8/20 μ s)

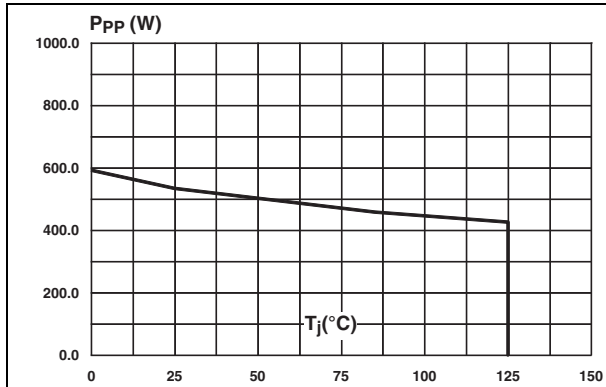

Figure 5. Peak pulse power versus initial junction temperature (pulse 10/1000 μ s)

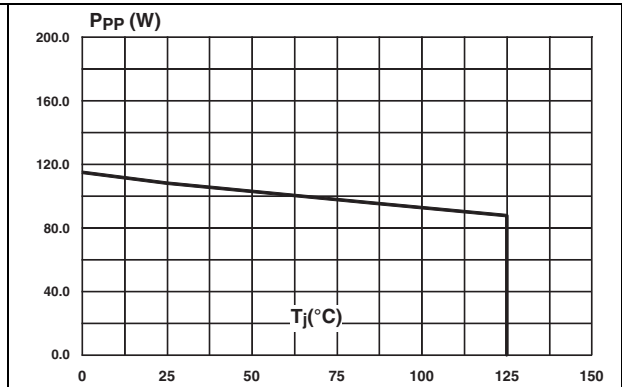

Figure 6. Peak pulse power versus exponential pulse duration

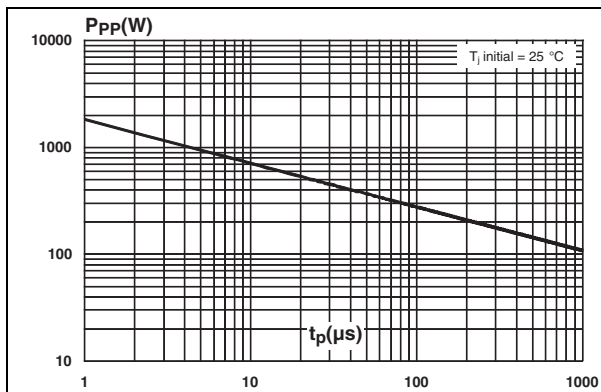

Figure 7. Clamping voltage versus peak pulse current (8/20 μ s, typical values)

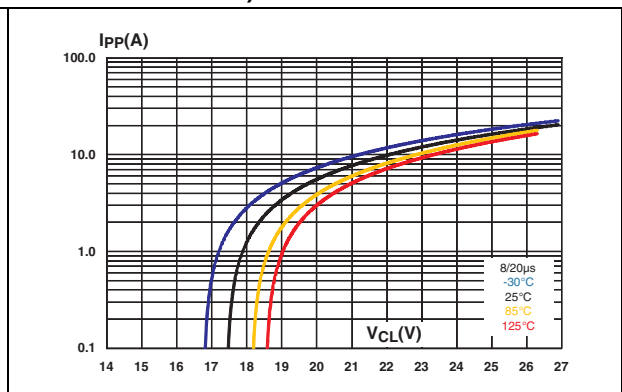

Figure 8. Leakage current versus junction temperature (typical values)

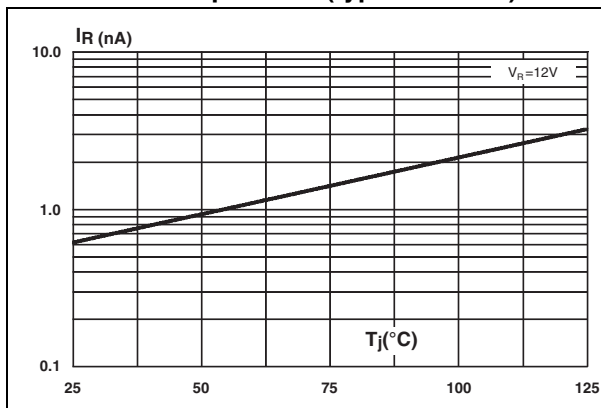

Figure 9. Forward voltage drop versus peak forward current (typical values)

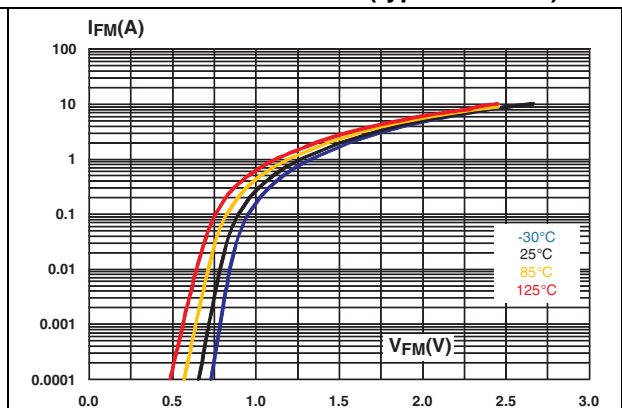

Figure 10. Junction capacitance versus line voltage (typical values)

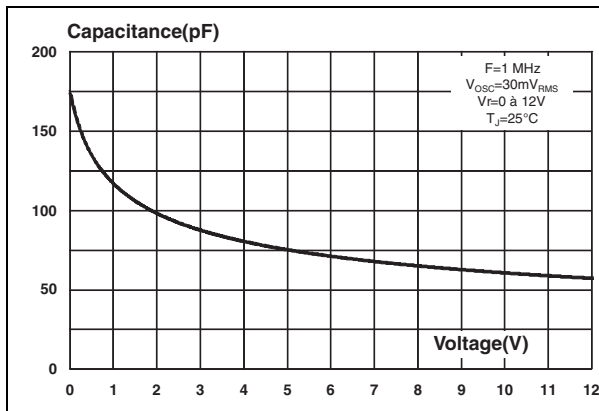

Figure 11. Junction capacitance versus frequency for different bias voltages (P = -12 dBm)

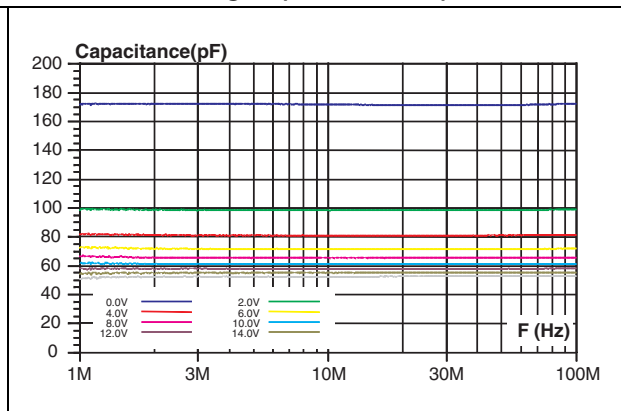

Figure 12. Breakdown voltage versus initial junction temperature (typical value)

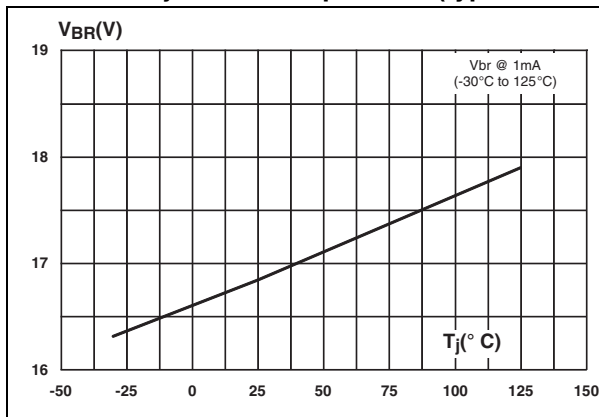

Figure 13. S21 insertion losses versus frequency response

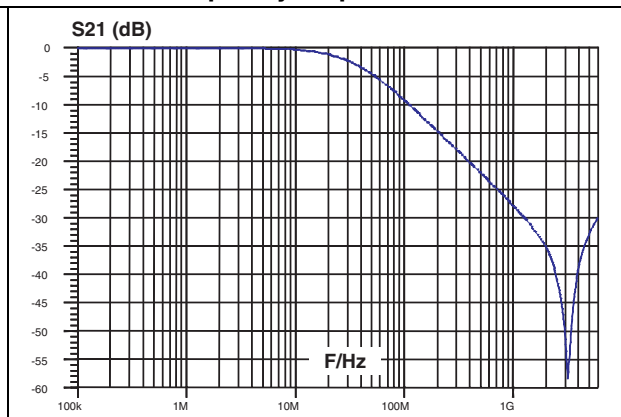

Figure 14. ESD response to IEC 61000-4-2 (+8 kV contact discharge)

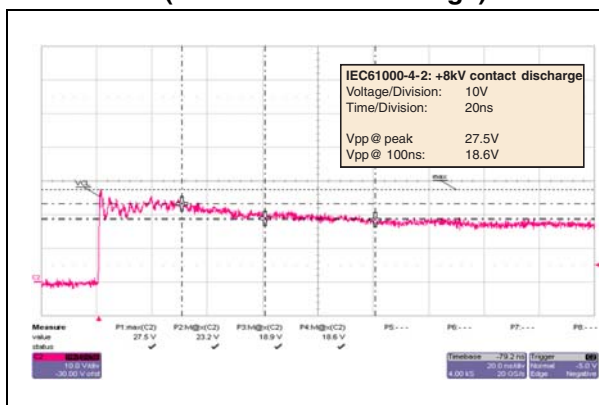
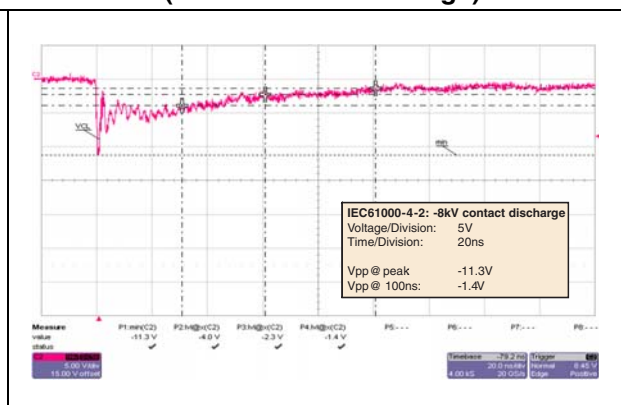
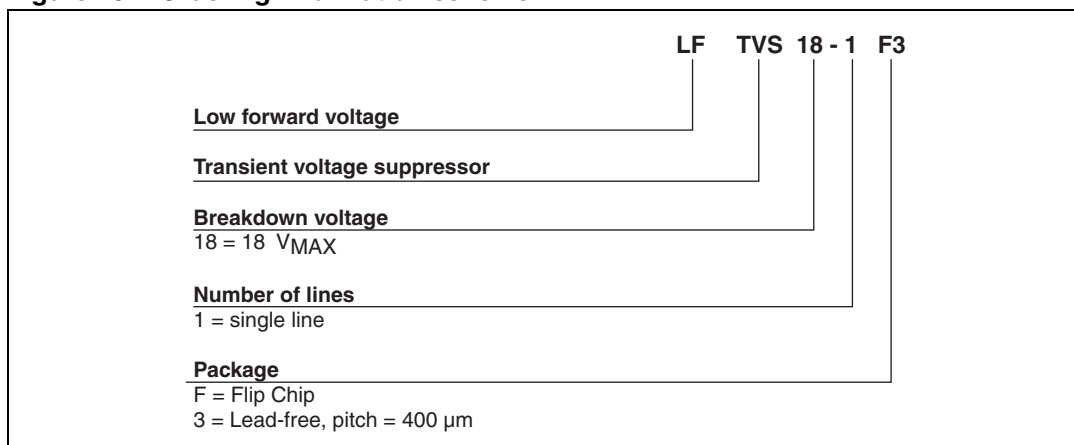

Figure 15. ESD response to IEC 61000-4-2 (-8 kV contact discharge)



2 Ordering information scheme

Figure 16. Ordering information scheme



3 Package information

In order to meet environmental requirements, ST offers these devices in different grades of ECOPACK[®] packages, depending on their level of environmental compliance. ECOPACK[®] specifications, grade definitions and product status are available at: www.st.com. ECOPACK[®] is an ST trademark.

Figure 17. Package dimensions

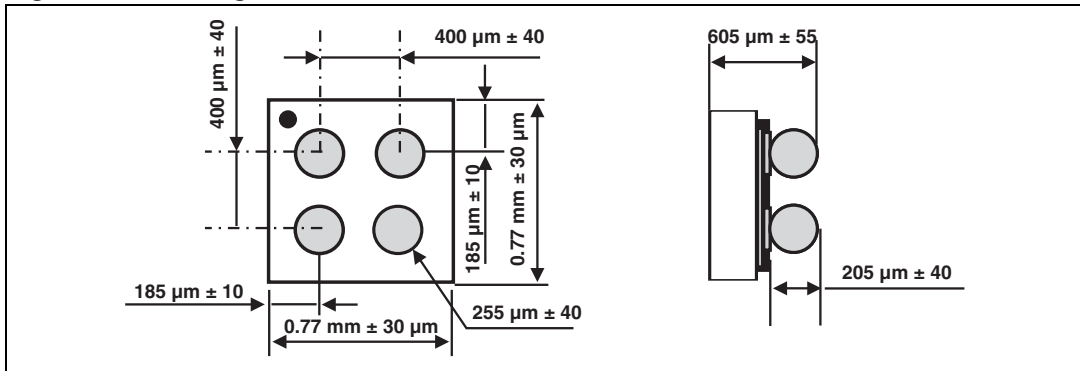
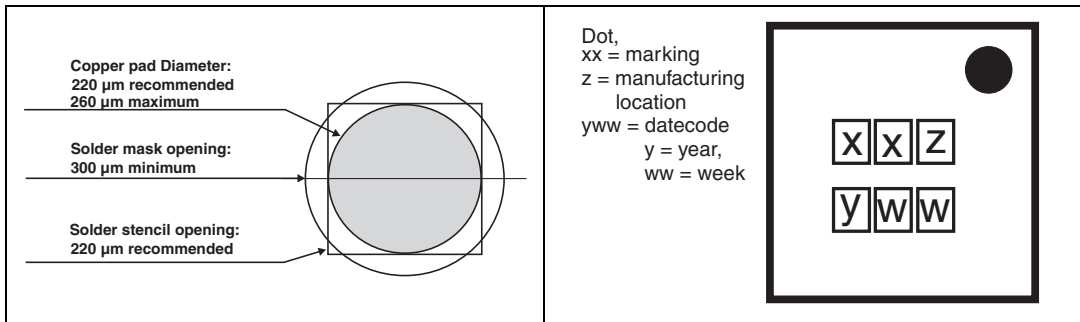
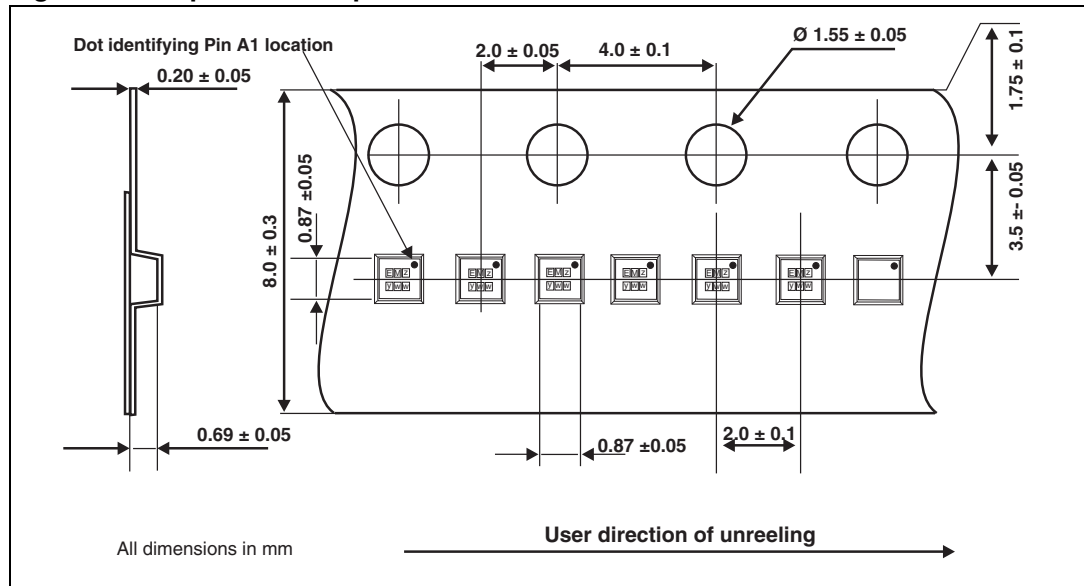

Figure 18. Foot print recommendations **Figure 19. Marking**



Note: Product marking may be rotated by 90° for assembly plant differentiation. In no case should this product marking be used to orient the component for its placement on a PCB. Only pin 1 mark is to be used for this purpose.

Figure 20. Tape and reel specifications



Note: More information is available in the Application notes:
 AN2348: “400 µm Flip Chip: package description and recommendations for use”
 AN1751: “EMI Filters: recommendations and measurements”

4 Ordering information

Table 3. Ordering information

Order code	Marking ⁽¹⁾	Package	Weight	Base qty	Delivery mode
LFTVS18-1F3	EM	Flip Chip	0.79 mg	10 000	Tape and reel (7")

1. The marking can be rotated by 90° to differentiate assembly location

5 Revision history

Table 4. Document revision history

Date	Revision	Changes
06-Mar-2008	1	Initial release.
04-Sep-2008	2	Updated V_F to 1.05 V. Updated Figure 20 to show pitch of 2.0 mm. Updated I_{FSM} to 11 A. Updated Figure 5 , Figure 7 , and Figure 8 .
14-Sep-2012	3	Updated all graphics in 1: Characteristics . Added tolerances to pocket dimensions in Figure 20 .

Please Read Carefully:

Information in this document is provided solely in connection with ST products. STMicroelectronics NV and its subsidiaries ("ST") reserve the right to make changes, corrections, modifications or improvements, to this document, and the products and services described herein at any time, without notice.

All ST products are sold pursuant to ST's terms and conditions of sale.

Purchasers are solely responsible for the choice, selection and use of the ST products and services described herein, and ST assumes no liability whatsoever relating to the choice, selection or use of the ST products and services described herein.

No license, express or implied, by estoppel or otherwise, to any intellectual property rights is granted under this document. If any part of this document refers to any third party products or services it shall not be deemed a license grant by ST for the use of such third party products or services, or any intellectual property contained therein or considered as a warranty covering the use in any manner whatsoever of such third party products or services or any intellectual property contained therein.

UNLESS OTHERWISE SET FORTH IN ST'S TERMS AND CONDITIONS OF SALE ST DISCLAIMS ANY EXPRESS OR IMPLIED WARRANTY WITH RESPECT TO THE USE AND/OR SALE OF ST PRODUCTS INCLUDING WITHOUT LIMITATION IMPLIED WARRANTIES OF MERCHANTABILITY, FITNESS FOR A PARTICULAR PURPOSE (AND THEIR EQUIVALENTS UNDER THE LAWS OF ANY JURISDICTION), OR INFRINGEMENT OF ANY PATENT, COPYRIGHT OR OTHER INTELLECTUAL PROPERTY RIGHT.

UNLESS EXPRESSLY APPROVED IN WRITING BY TWO AUTHORIZED ST REPRESENTATIVES, ST PRODUCTS ARE NOT RECOMMENDED, AUTHORIZED OR WARRANTED FOR USE IN MILITARY, AIR CRAFT, SPACE, LIFE SAVING, OR LIFE SUSTAINING APPLICATIONS, NOR IN PRODUCTS OR SYSTEMS WHERE FAILURE OR MALFUNCTION MAY RESULT IN PERSONAL INJURY, DEATH, OR SEVERE PROPERTY OR ENVIRONMENTAL DAMAGE. ST PRODUCTS WHICH ARE NOT SPECIFIED AS "AUTOMOTIVE GRADE" MAY ONLY BE USED IN AUTOMOTIVE APPLICATIONS AT USER'S OWN RISK.

Resale of ST products with provisions different from the statements and/or technical features set forth in this document shall immediately void any warranty granted by ST for the ST product or service described herein and shall not create or extend in any manner whatsoever, any liability of ST.

ST and the ST logo are trademarks or registered trademarks of ST in various countries.

Information in this document supersedes and replaces all information previously supplied.

The ST logo is a registered trademark of STMicroelectronics. All other names are the property of their respective owners.

© 2012 STMicroelectronics - All rights reserved

STMicroelectronics group of companies

Australia - Belgium - Brazil - Canada - China - Czech Republic - Finland - France - Germany - Hong Kong - India - Israel - Italy - Japan - Malaysia - Malta - Morocco - Philippines - Singapore - Spain - Sweden - Switzerland - United Kingdom - United States of America

www.st.com

Mouser Electronics

Authorized Distributor

Click to View Pricing, Inventory, Delivery & Lifecycle Information:

[STMicroelectronics:](#)

[LFTVS18-1F3](#)