



PD55008-E PD55008S-E

RF POWER transistor, LdmoST plastic family N-channel enhancement-mode, lateral MOSFETs

Features

- Excellent thermal stability
- Common source configuration
- $P_{OUT} = 8\text{ W}$ with 17dB gain @ 500 MHz/12.5 V
- New RF plastic package

Description

The device is a common source N-channel, enhancement-mode lateral field-effect RF power transistor. It is designed for high gain, broad band commercial and industrial applications. It operates at 12 V in common source mode at frequencies up to 1 GHz.

The device boasts the excellent gain, linearity and reliability of ST's latest LDMOS technology mounted in the first true SMD plastic RF power package, PowerSO-10RF. The device's superior linearity performance makes it an ideal solution for car mobile radio.

The PowerSO-10 plastic package, designed to offer high reliability, is the first ST JEDEC approved, high power SMD package. It has been specially optimized for RF needs and offers excellent RF performances and ease of assembly.

Mounting recommendations are available in www.st.com/rf/ (look for application note AN1294).

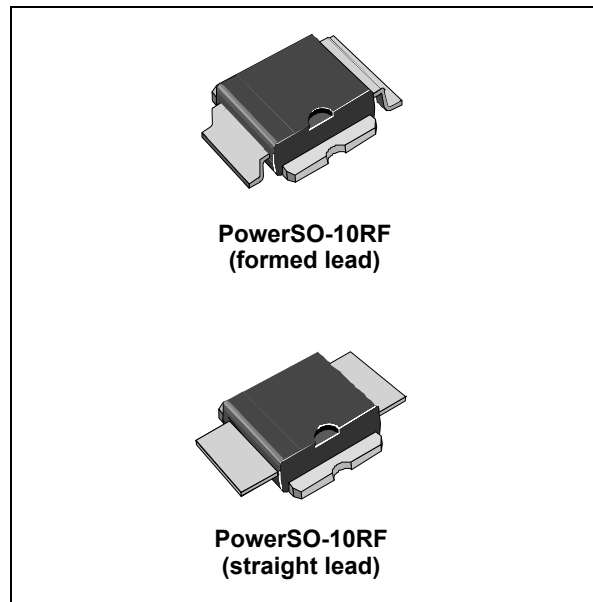

Figure 1. Pin connection

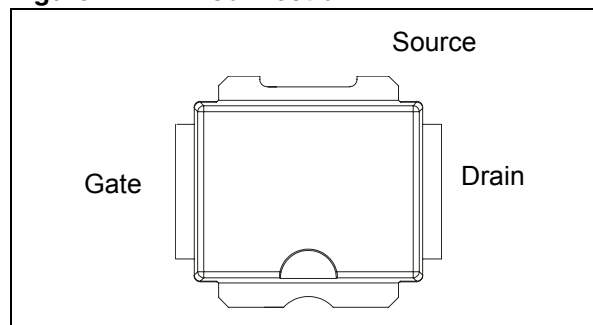

Table 1. Device summary

Order code	Package	Packing
PD55008-E	PowerSO-10RF (formed lead)	Tube
PD55008S-E	PowerSO-10RF (straight lead)	Tube
PD55008TR-E	PowerSO-10RF (formed lead)	Tape and reel
PD55008STR-E	PowerSO-10RF (straight lead)	Tape and reel

Contents

1	Electrical data	3
1.1	Maximum ratings	3
1.2	Thermal data	3
2	Electrical characteristics	4
2.1	Static	4
2.2	Dynamic	4
2.3	Moisture sensitivity level	4
3	Impedance	5
4	Typical performance	6
4.1	PD55008-E	7
4.2	PD54003S-E	9
5	Test circuit	11
6	Circuit layout	13
7	Common source s-parameter	14
8	Package mechanical data	20
9	Revision history	24

1 Electrical data

1.1 Maximum ratings

Table 2. Absolute maximum ratings ($T_{CASE} = 25^{\circ}C$)

Symbol	Parameter	Value	Unit
$V_{(BR)DSS}$	Drain-source voltage	40	V
V_{GS}	Gate-source voltage	± 20	V
I_D	Drain current	4	A
P_{DISS}	Power dissipation (@ $T_C = 70^{\circ}C$)	52.8	W
T_J	Max. operating junction temperature	165	$^{\circ}C$
T_{STG}	Storage temperature	-65 to +150	$^{\circ}C$

1.2 Thermal data

Table 3. Thermal data

Symbol	Parameter	Value	Unit
R_{thJC}	Junction - case thermal resistance	1.8	$^{\circ}C/W$

2 Electrical characteristics

$T_{CASE} = +25\text{ }^{\circ}\text{C}$

2.1 Static

Table 4. Static

Symbol	Test conditions		Min.	Typ.	Max.	Unit
I_{DSS}	$V_{GS} = 0$	$V_{DS} = 28\text{ V}$			1	μA
I_{GSS}	$V_{GS} = 20\text{ V}$	$V_{DS} = 0$			1	μA
$V_{GS(Q)}$	$V_{DS} = 10\text{ V}$	$I_D = 150\text{ mA}$	2.0		5.0	V
$V_{DS(ON)}$	$V_{GS} = 10\text{ V}$	$I_D = 1.5\text{ A}$			0.67	V
g_{FS}	$V_{DS} = 10\text{ V}$	$I_D = 1.5\text{ A}$		1.6		mho
C_{ISS}	$V_{GS} = 0$	$V_{DS} = 12.5\text{ V}$		58		pF
C_{OSS}	$V_{GS} = 0$	$V_{DS} = 12.5\text{ V}$		38		pF
C_{RSS}	$V_{GS} = 0$	$V_{DS} = 12.5\text{ V}$		2.8		pF

2.2 Dynamic

Table 5. Dynamic

Symbol	Test conditions		Min.	Typ.	Max.	Unit
P_{OUT}	$V_{DD} = 12.5\text{ V}$, $I_{DQ} = 150\text{ mA}$	$f = 500\text{ MHz}$	8			W
G_P	$V_{DD} = 12.5\text{ V}$, $I_{DQ} = 150\text{ mA}$, $P_{OUT} = 8\text{ W}$	$f = 500\text{ MHz}$	15	17		dB
η_D	$V_{DD} = 12.5\text{ V}$, $I_{DQ} = 150\text{ mA}$, $P_{OUT} = 8\text{ W}$	$f = 500\text{ MHz}$	50	55		%
Load mismatch	$V_{DD} = 15.5\text{ V}$, $I_{DQ} = 150\text{ mA}$, $P_{OUT} = 8\text{ W}$	$f = 500\text{ MHz}$ All phase angles	20:1			VSWR

2.3 Moisture sensitivity level

Table 6. Moisture sensitivity level

Test methodology	Rating
J-STD-020B	MSL 3

3 Impedance

Figure 2. Current conventions



Table 7. Impedance data

PD55008			PD55008S		
Freq. (MHz)	Z _{IN} (Ω)	Z _{DL} (Ω)	Freq. (MHz)	Z _{IN} (Ω)	Z _{DL} (Ω)
480	1.141 - j 2.054	1.649 + j 2.916	480	1.075 - j 2.727	2.046 + j 1.960
500	1.589 - j 1.185	1.561 + j 2.639	500	1.409 - j 3.448	2.129 + j 3.219
520	1.649 - j 1.965	1.716 + j 1.552	520	1.586 - j 2.087	3.082 + j 2.043
800	1.05 + j 0.54	2.62 - j 1.91			
850	1.50 + j 1.00	2.26 - j 1.54			
900	1.95 + j 2.28	2.70 - j 1.90			

4 Typical performance

Figure 3. Capacitance vs. drain voltage

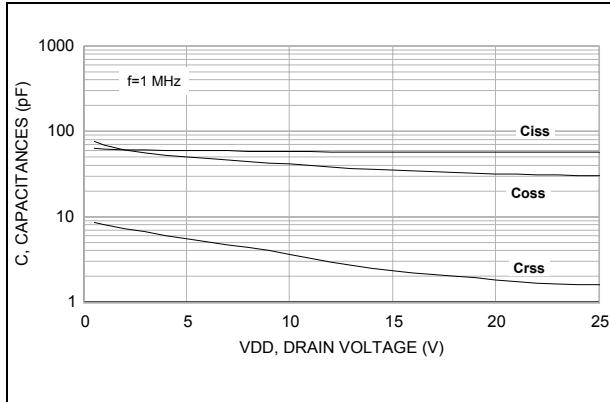

Figure 4. Drain current vs. gate-source voltage

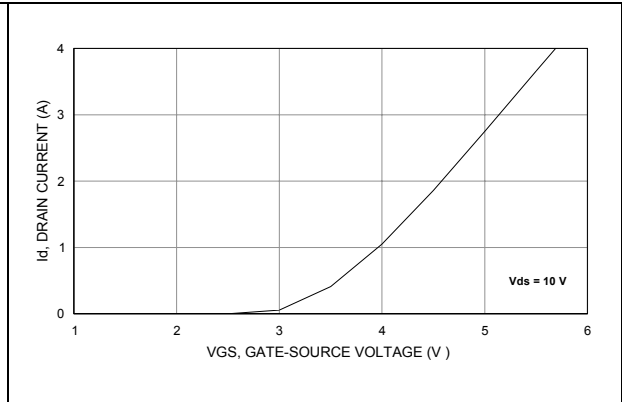
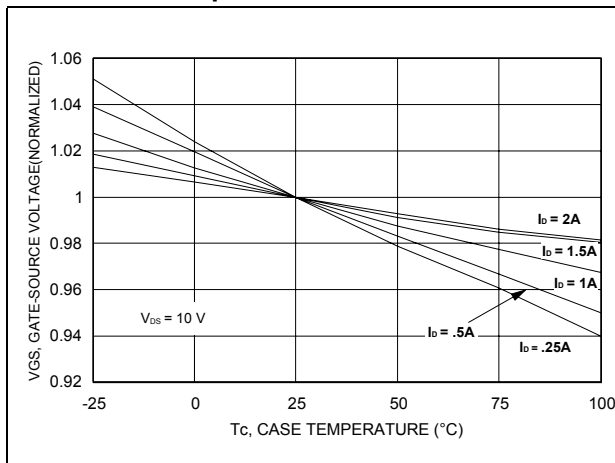

Figure 5. Gate-source voltage vs. case temperature



4.1 PD55008-E

Figure 6. Output power vs. input power

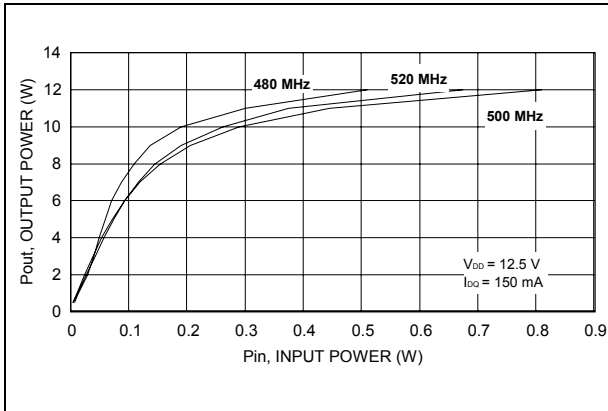

Figure 7. Power gain vs. output power

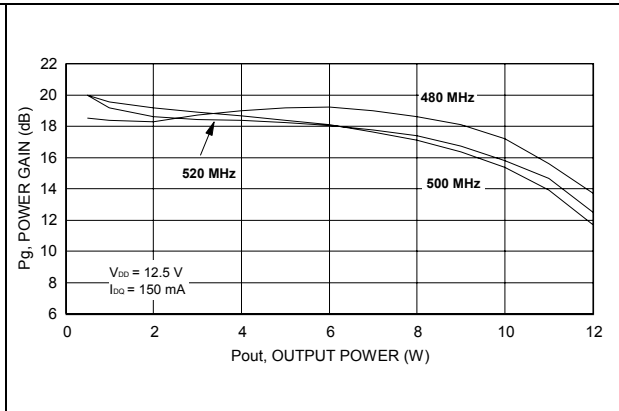

Figure 8. Drain efficiency vs. output power

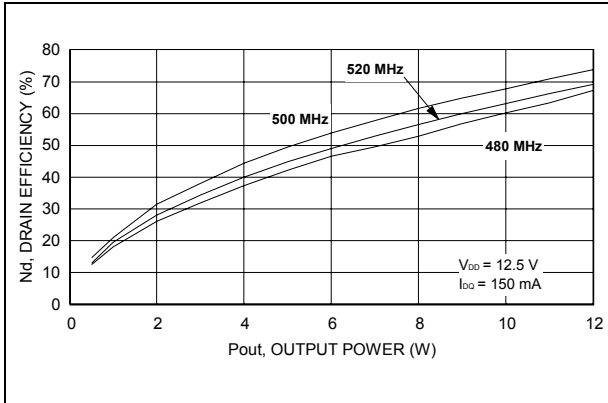

Figure 9. Input return loss vs. output power

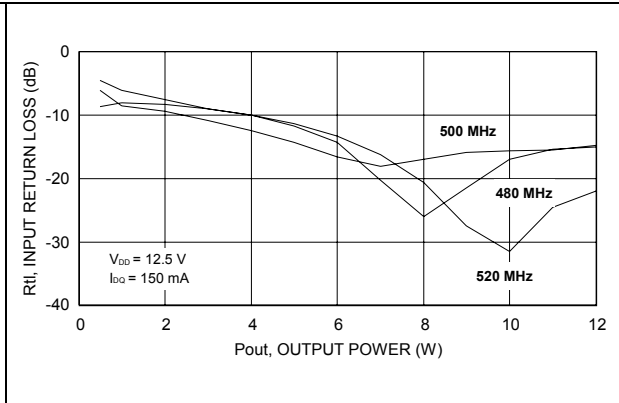

Figure 10. Output power vs. bias current

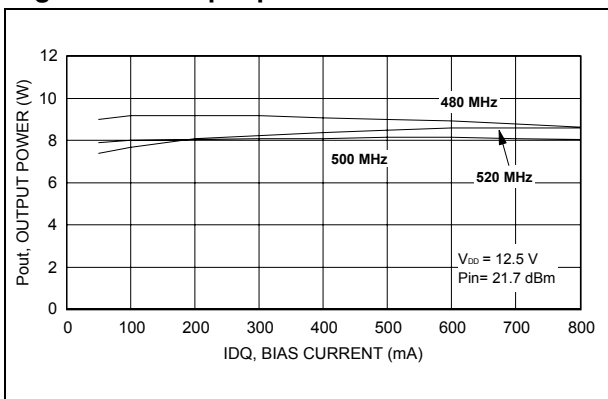

Figure 11. Drain efficiency vs. bias current

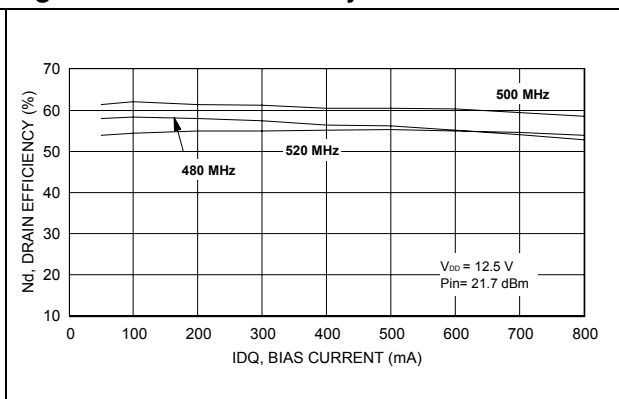

Figure 12. Output power vs. supply voltage

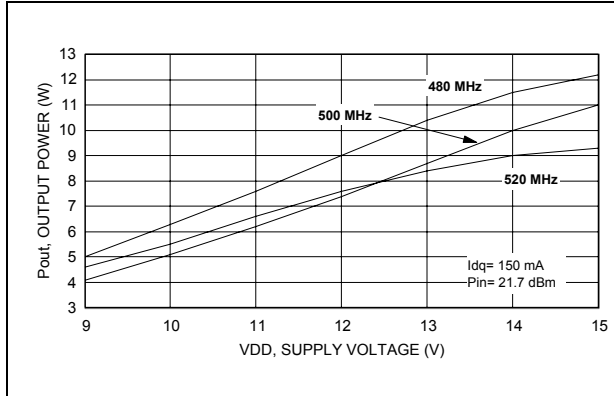

Figure 13. Drain efficiency vs. supply voltage

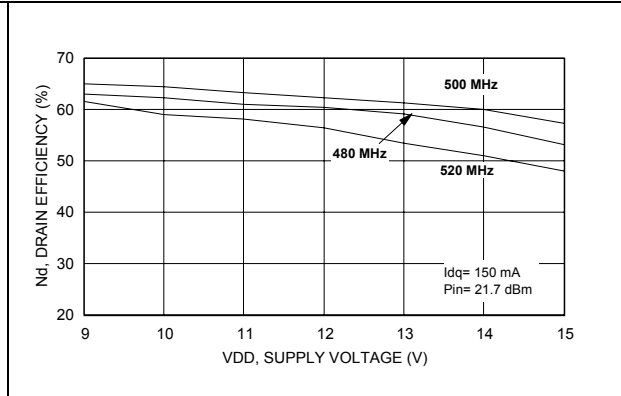

Figure 14. Output power vs. gate-source voltage

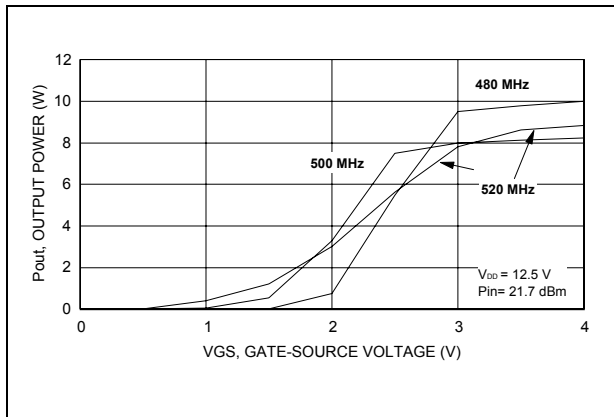

Table 8. Output power vs. input power

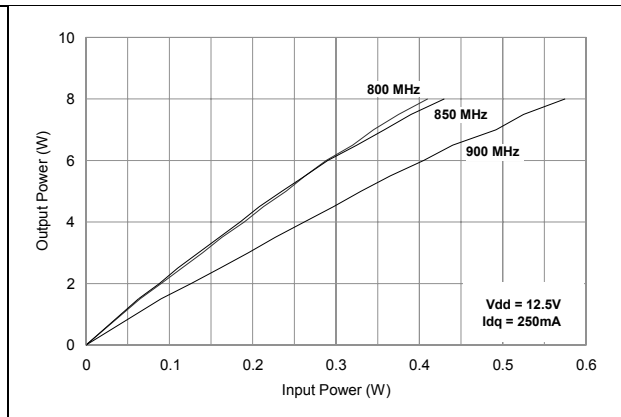

Figure 15. Drain efficiency vs. output power

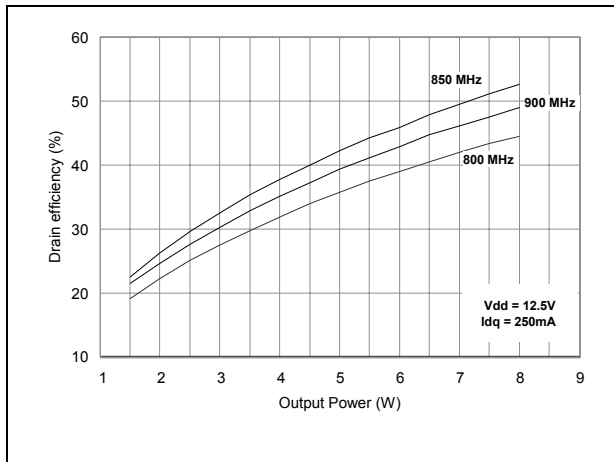
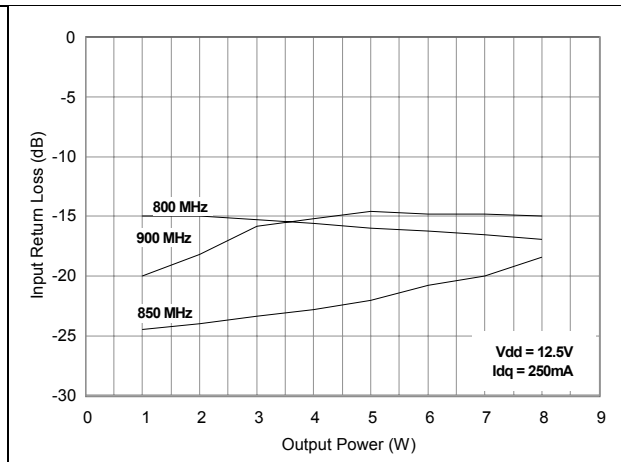

Figure 16. Input return loss vs. output power



4.2 PD54003S-E

Figure 17. Output power vs. input power

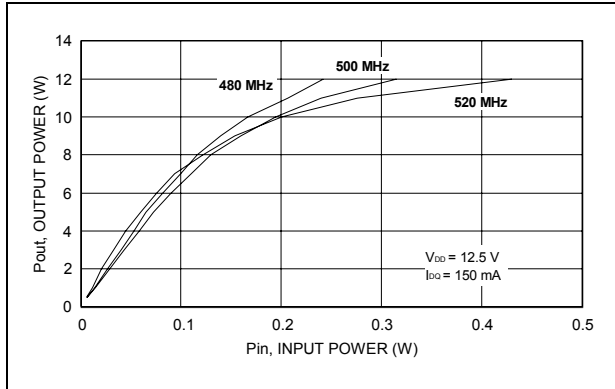

Figure 18. Power gain vs. output power

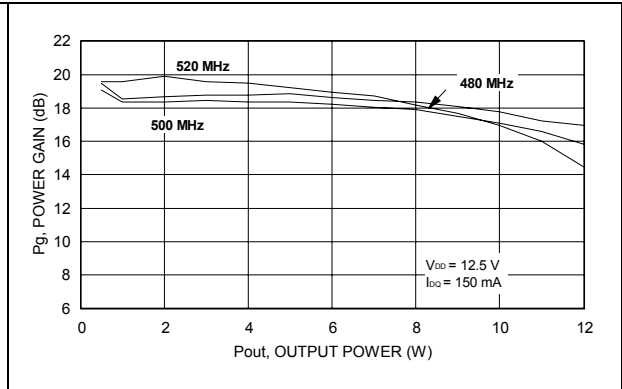

Figure 19. Drain efficiency vs. output power

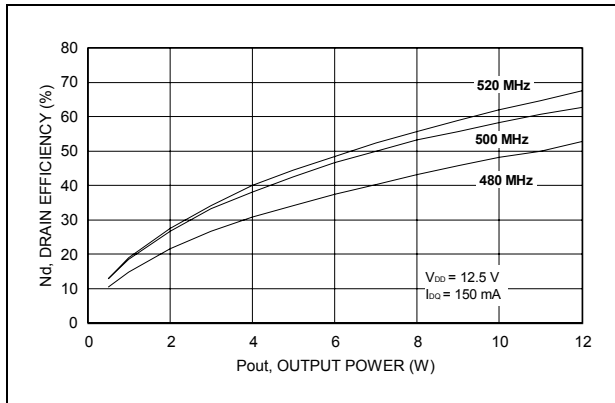

Figure 20. Input return loss vs. output power

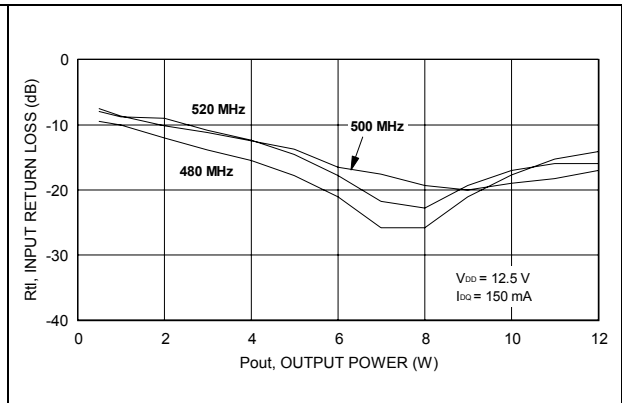

Figure 21. Output power vs. bias current

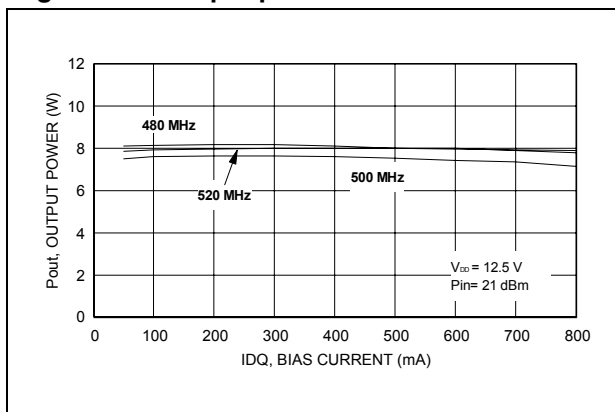

Figure 22. Drain efficiency vs. bias current

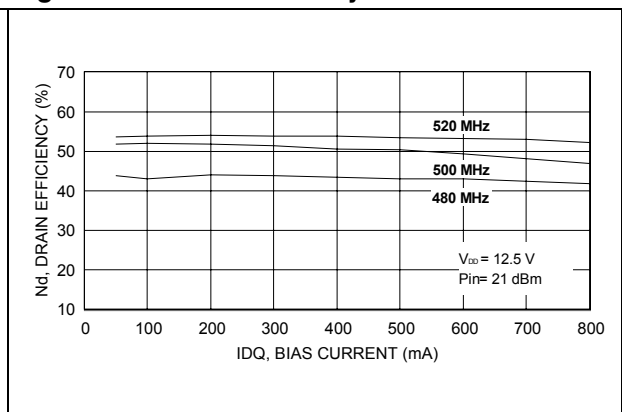

Figure 23. Output power vs. supply voltage

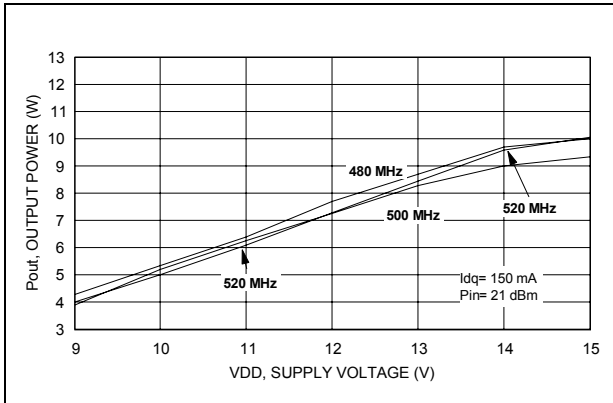

Figure 24. Drain efficiency vs. supply voltage

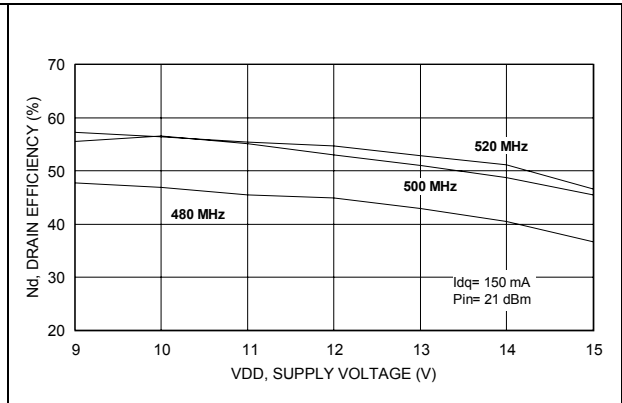
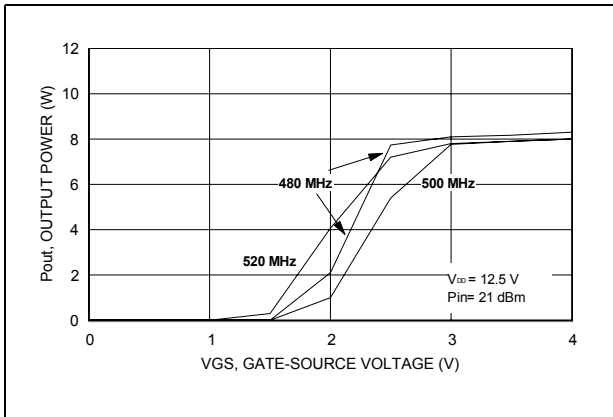

Figure 25. Output power vs. supply voltage



5 Test circuit

Figure 26. Test circuit schematic

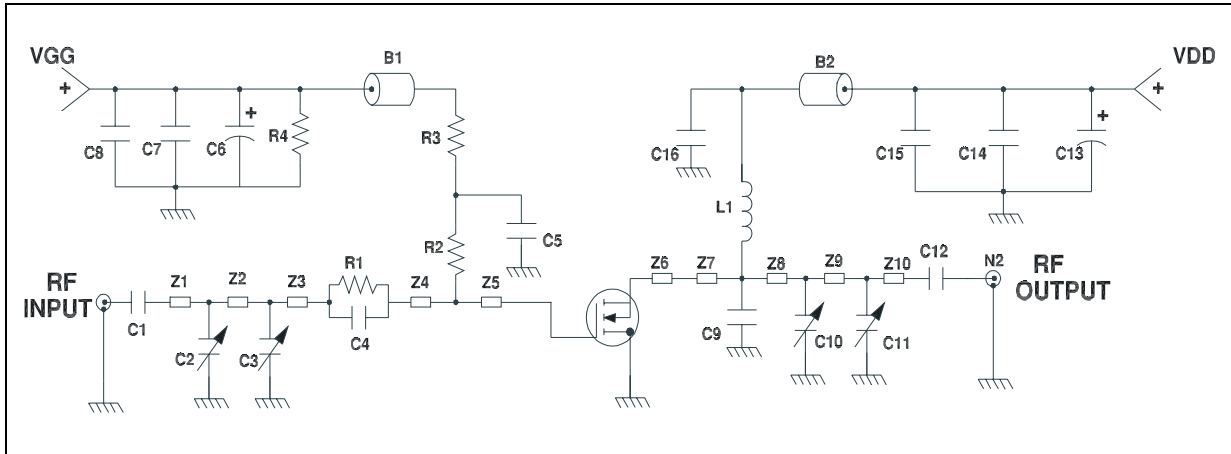

Table 9. Test circuit component part list

Component	Description
B1, B2	Short ferrite bead, fair rite products (2743021446)
C1, C12	240 pF, 100 mil chip capacitor
C2,C3,C10,C11	0 TO 20 pF, trimmer capacitor
C4	82 pF, 100 mil chip capacitor
C5,C16	120 pF, 100 mil chip capacitor
C6,C13	10 μ F, 50 V electrolytic capacitor
C7, C14	1.200 pF, 100 mil chip capacitor
C8,C15	0.1 F, 100 mil chip capacitor
C9	30 pF, 100 mil chip capacitor
L1	55.5 nH, turn, Coilcraft
N1, N2	Type N flange mount
R1	15 Ω , 0805 chip resistor
R2	51 Ω , 1/2 W resistor
R3	10 Ω , 0805 chip resistor
R4	33 k Ω , 1/8 Ω resistor
Z1	0.451" X 0.080" microstrip
Z2	1.005" X 0.080" microstrip
Z3	0.020" X 0.080" microstrip
Z4	0.155" X 0.080" microstrip
Z5,Z6	0.260" X 0.233" microstrip
Z7	0.065" X 0.080" microstrip

Table 9. Test circuit component part list (continued)

Component	Description
Z8	0.266" X 0.080" microstrip
Z9	1.113" X 0.080" microstrip
Z10	0.433" X 0.080" microstrip
Board	Roger ultra lam 2000 THK 0.030" $\epsilon_r = 2.55$ 2oz ED Cu both sides

6 Circuit layout

Figure 27. Test fixture component layout

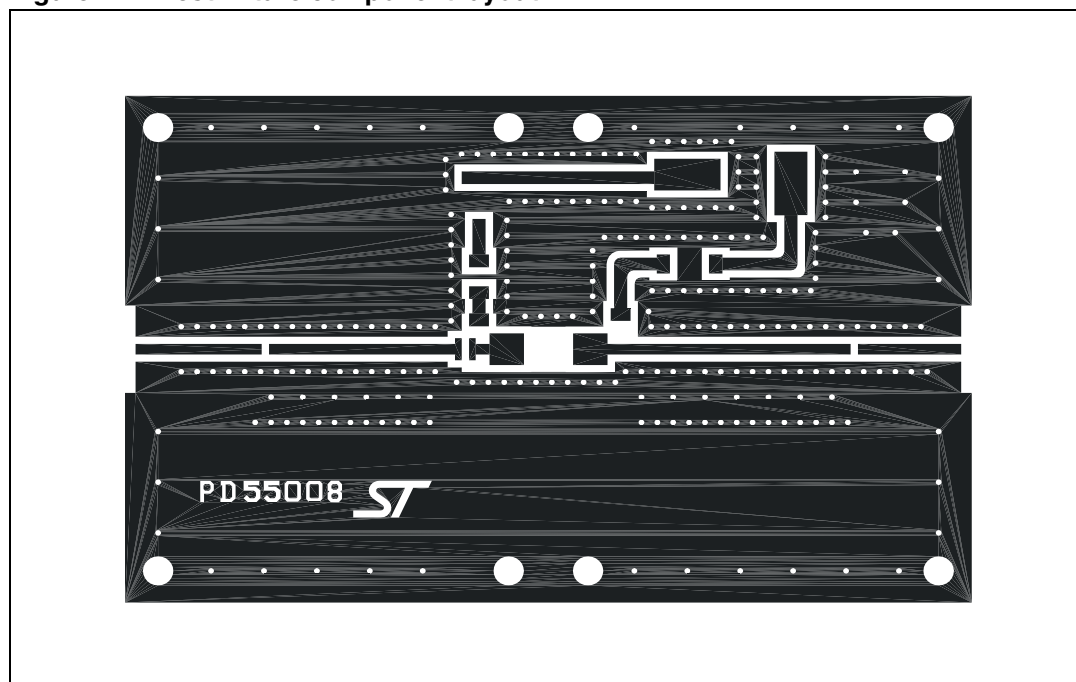
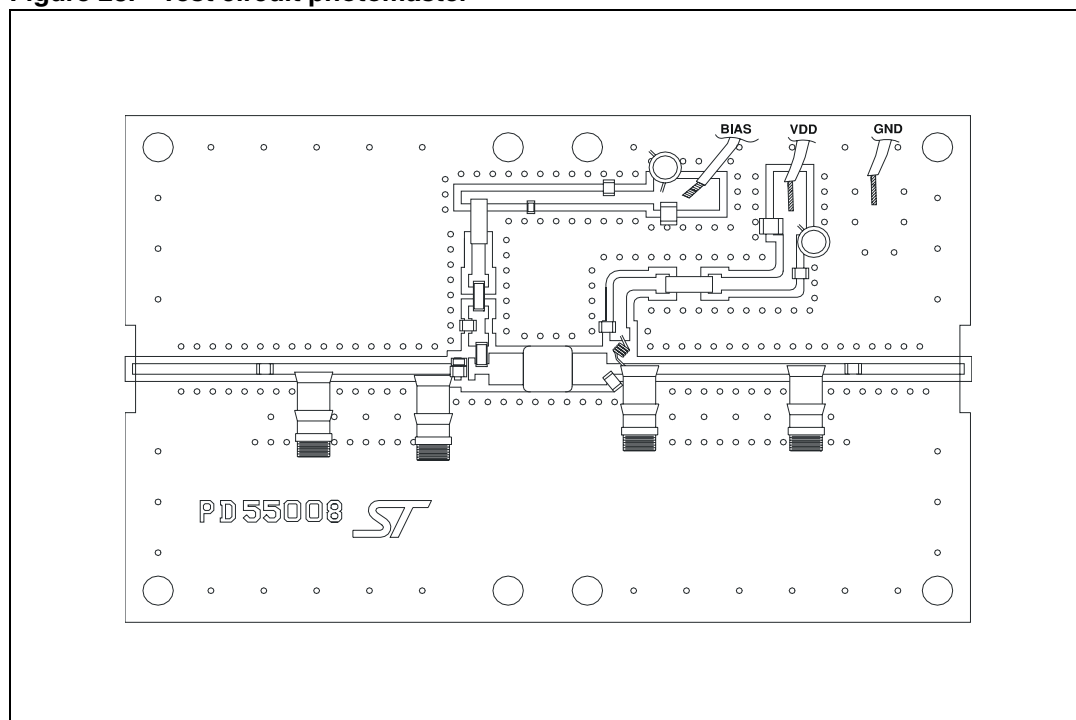

Figure 28. Test circuit photomaster



7 Common source s-parameter

Table 10. S-parameter for PD55008-E ($V_{DS} = 12.5$ V, $I_{DS} = 150$ mA)

Freq (MHz)	$ S_{11} $	$S_{11} < \Phi$	$ S_{21} $	$S_{21} < \Phi$	$ S_{12} $	$S_{12} < \Phi$	$ S_{22} $	$S_{22} < \Phi$
50	0.781	-141	16.89	93	0.035	4	0.685	-137
100	0.784	-157	8.14	77	0.035	-11	0.681	-151
150	0.803	-162	5.19	67	0.032	-18	0.704	-157
200	0.830	-165	3.69	58	0.030	-26	0.743	-159
250	0.852	-167	2.77	50	0.027	-34	0.773	-161
300	0.873	-169	2.16	44	0.025	-39	0.812	-164
350	0.892	-171	1.72	37	0.022	-43	0.844	-166
400	0.906	-172	1.40	33	0.020	-45	0.862	-168
450	0.919	-173	1.16	28	0.017	-47	0.888	-170
500	0.928	-175	0.97	24	0.015	-51	0.903	-171
550	0.936	-176	0.83	20	0.012	-52	0.913	-173
600	0.941	-177	0.71	17	0.010	-50	0.921	-174
650	0.946	-178	0.62	14	0.010	-52	0.926	-176
700	0.952	-179	0.55	11	0.008	-47	0.934	-177
750	0.954	180	0.48	9	0.006	-48	0.937	-178
800	0.957	179	0.44	7	0.006	-40	0.940	-180
850	0.959	178	0.39	4	0.004	-30	0.950	179
900	0.960	177	0.35	3	0.005	-1	0.952	178
950	0.963	176	0.32	1	0.004	17	0.957	177
1000	0.964	176	0.29	-1	0.004	28	0.958	176
1050	0.964	175	0.27	-3	0.004	43	0.953	175
1100	0.966	174	0.25	-4	0.005	42	0.955	174
1150	0.963	173	0.23	-6	0.005	59	0.954	173
1200	0.964	174	0.21	-8	0.007	58	0.952	172
1250	0.962	172	0.20	-9	0.008	57	0.956	171
1300	0.961	172	0.18	-11	0.008	57	0.953	171
1350	0.960	171	0.17	-11	0.010	68	0.950	170
1400	0.957	170	0.16	-12	0.010	61	0.957	169
1450	0.957	169	0.15	-12	0.011	67	0.942	168
1500	0.952	169	0.14	-13	0.011	76	0.944	167

Table 11. S-parameter PD55003-E ($V_{DS} = 12.5\text{ V}$, $I_{DS} = 800\text{ mA}$)

Freq (MHz)	$ S_{11} $	$\angle S_{11}$	$ S_{21} $	$\angle S_{21}$	$ S_{12} $	$\angle S_{12}$	$ S_{22} $	$\angle S_{22}$
50	0.832	-156	20.68	90	0.022	3	0.740	-157
100	0.833	-167	9.98	80	0.022	-6	0.734	-165
150	0.839	-171	6.51	73	0.020	-11	0.741	-169
200	0.851	-172	4.78	67	0.020	-16	0.756	-169
250	0.851	-174	3.71	60	0.018	-20	0.767	-170
300	0.861	-174	3.00	55	0.017	-22	0.791	-172
350	0.872	-175	2.46	49	0.016	-23	0.813	-172
400	0.883	-176	2.06	44	0.014	-26	0.828	-173
450	0.894	-177	1.75	40	0.014	-26	0.849	-174
500	0.902	-178	1.50	35	0.012	-26	0.863	-175
550	0.910	-179	1.30	31	0.011	-27	0.874	-176
600	0.919	-179	1.14	28	0.010	-29	0.886	-177
650	0.923	180	1.01	25	0.009	-25	0.890	-178
700	0.929	179	0.90	22	0.008	-20	0.898	-179
750	0.934	178	0.81	19	0.007	-10	0.905	-180
800	0.937	177	0.73	16	0.006	-3	0.908	179
850	0.939	177	0.66	13	0.005	11	0.925	178
900	0.942	176	0.60	11	0.005	17	0.926	177
950	0.944	175	0.55	9	0.006	20	0.929	176
1000	0.949	175	0.51	6	0.006	25	0.935	176
1050	0.952	174	0.47	4	0.008	35	0.933	174
1100	0.954	173	0.43	2	0.007	38	0.935	173
1150	0.952	173	0.40	0	0.009	48	0.936	173
1200	0.954	172	0.37	-2	0.009	50	0.936	172
1250	0.951	171	0.34	-4	0.010	53	0.937	171
1300	0.950	171	0.32	-5	0.011	51	0.935	170
1350	0.951	170	0.30	-6	0.011	60	0.935	169
1400	0.948	170	0.28	-8	0.012	56	0.939	169
1450	0.947	169	0.27	-9	0.012	64	0.928	168
1500	0.944	168	0.25	-9	0.013	67	0.933	166

Table 12. S-parameter for PD55003-E ($V_{DS} = 12.5\text{ V}$, $I_{DS} = 1.5\text{ A}$)

Freq (MHz)	$ S_{11} $	$\angle S_{11}$	$ S_{21} $	$\angle S_{21}$	$ S_{12} $	$\angle S_{12}$	$ S_{22} $	$\angle S_{22}$
50	0.797	-161	20.72	90	0.020	2	0.743	-159
100	0.824	-168	10.01	80	0.019	-5	0.741	-167
150	0.849	-171	6.54	74	0.019	-9	0.746	-170
200	0.861	-173	4.83	67	0.018	-14	0.759	-171
250	0.870	-175	3.76	61	0.017	-19	0.770	-171
300	0.879	-175	3.04	56	0.016	-20	0.791	-173
350	0.887	-176	2.51	50	0.015	-21	0.811	-173
400	0.897	-177	2.11	45	0.013	-26	0.824	-174
450	0.905	-178	1.80	41	0.013	-23	0.847	-175
500	0.911	-178	1.54	37	0.011	-21	0.858	-175
550	0.917	-179	1.35	33	0.010	-23	0.871	-176
600	0.924	-180	1.17	29	0.009	-21	0.881	-177
650	0.927	179	1.04	26	0.009	-16	0.887	-178
700	0.933	179	0.93	23	0.007	-8	0.899	-179
750	0.937	178	0.83	20	0.007	-3	0.901	180
800	0.940	177	0.76	17	0.006	-2	0.906	179
850	0.941	177	0.68	14	0.007	0	0.918	178
900	0.944	176	0.63	12	0.006	21	0.920	177
950	0.946	175	0.58	10	0.008	17	0.927	176
1000	0.948	174	0.53	7	0.007	43	0.929	175
1050	0.952	174	0.49	5	0.008	44	0.929	175
1100	0.953	173	0.45	3	0.008	44	0.930	173
1150	0.952	172	0.42	1	0.009	47	0.931	173
1200	0.951	172	0.39	-1	0.010	51	0.928	172
1250	0.952	171	0.36	-3	0.010	51	0.932	171
1300	0.952	171	0.34	-5	0.011	52	0.931	170
1350	0.949	170	0.31	-7	0.011	53	0.931	169
1400	0.947	169	0.29	8	0.011	58	0.937	169
1450	0.945	169	0.28	-9	0.012	60	0.926	168
1500	0.942	168	0.26	-9	0.012	64	0.927	166

Table 13. S-parameter for PD55003S-E ($V_{DS} = 12.5\text{ V}$, $I_{DS} = 0.15\text{ A}$)

Freq (MHz)	$ S_{11} $	$S_{11} < \Phi$	$ S_{21} $	$S_{21} < \Phi$	$ S_{12} $	$S_{12} < \Phi$	$ S_{22} $	$S_{22} < \Phi$
50	0.753	-146	15.56	92	0.036	4	0.666	-144
100	0.781	-159	7.52	78	0.036	-9	0.684	-157
150	0.812	-163	4.83	70	0.033	-17	0.717	-161
200	0.834	-166	3.46	62	0.032	-25	0.747	-162
250	0.856	-168	2.63	54	0.029	-31	0.784	-164
300	0.873	-169	2.07	48	0.028	-37	0.814	-165
350	0.887	-170	1.66	42	0.025	-42	0.836	-166
400	0.902	-172	1.37	37	0.023	-45	0.859	-168
450	0.915	-173	1.14	33	0.021	-48	0.873	-169
500	0.925	-174	0.96	29	0.019	-52	0.890	-171
550	0.935	-175	0.83	25	0.017	-56	0.906	-171
600	0.942	-176	0.71	22	0.015	-55	0.911	-173
650	0.946	-176	0.63	19	0.014	-56	0.922	-174
700	0.950	-177	0.55	16	0.013	-60	0.933	-175
750	0.956	-178	0.49	14	0.012	-58	0.936	-176
800	0.959	-179	0.44	12	0.010	-67	0.942	-177
850	0.964	-180	0.40	9	0.008	-66	0.942	-178
900	0.961	180	0.36	7	0.008	-65	0.947	-179
950	0.965	179	0.33	5	0.005	-62	0.954	-179
1000	0.967	178	0.30	3	0.006	-67	0.957	180
1050	0.970	178	0.27	2	0.004	-66	0.960	179
1100	0.970	177	0.25	0	0.004	-43	0.958	178
1150	0.970	177	0.23	-2	0.003	-42	0.963	178
1200	0.971	176	0.22	-3	0.002	-58	0.961	177
1250	0.973	175	0.20	-5	0.001	-13	0.960	177
1300	0.969	175	0.19	-6	0.001	31	0.956	176
1350	0.971	174	0.18	-7	0.002	60	0.959	175
1400	0.969	174	0.16	-7	0.001	67	0.957	175
1450	0.969	173	0.15	-8	0.003	79	0.965	174
1500	0.968	173	0.14	-9	0.004	125	0.965	174

Table 14. S-parameter for PD55003S-E ($V_{DS} = 12.5$ V, $I_{DS} = 0.8$ A)

Freq (MHz)	$ S_{11} $	$\angle S_{11}$	$ S_{21} $	$\angle S_{21}$	$ S_{12} $	$\angle S_{12}$	$ S_{22} $	$\angle S_{22}$
50	0.862	-157	18.51	90	0.021	7	0.765	-161
100	0.861	-168	8.97	81	0.021	-4	0.767	-170
150	0.869	-171	5.88	76	0.020	-10	0.778	-172
200	0.872	-173	4.33	70	0.019	-14	0.782	-172
250	0.879	-174	3.40	65	0.019	-18	0.801	-173
300	0.888	-175	2.77	60	0.018	-20	0.810	-173
350	0.894	-175	2.30	55	0.017	-26	0.823	-173
400	0.905	-176	1.96	50	0.016	-31	0.836	-173
450	0.910	-177	1.67	46	0.015	-33	0.846	-174
500	0.916	-177	1.44	42	0.014	-31	0.862	-175
550	0.926	-178	1.27	38	0.013	-32	0.873	-175
600	0.930	-178	1.11	35	0.012	-37	0.880	-176
650	0.934	-179	0.96	32	0.011	-39	0.892	-176
700	0.938	-179	0.89	29	0.010	-38	0.901	-177
750	0.944	180	0.80	26	0.009	-38	0.907	-178
800	0.947	179	0.73	24	0.008	-38	0.913	-178
850	0.951	179	0.66	21	0.007	-36	0.914	-179
900	0.952	178	0.60	18	0.005	-44	0.920	180
950	0.953	178	0.55	16	0.005	-36	0.929	179
1000	0.955	177	0.51	14	0.005	-22	0.932	179
1050	0.957	176	0.48	11	0.004	-19	0.937	178
1100	0.960	176	0.44	9	0.003	-3	0.937	178
1150	0.961	176	0.41	7	0.004	2	0.943	177
1200	0.962	175	0.38	5	0.004	-4	0.940	177
1250	0.964	175	0.35	4	0.002	1	0.939	176
1300	0.961	174	0.33	2	0.003	31	0.937	176
1350	0.961	174	0.31	1	0.004	47	0.940	175
1400	0.959	173	0.29	1	0.003	56	0.939	174
1450	0.961	173	0.27	-1	0.004	59	0.945	173
1500	0.962	172	0.26	-2	0.004	87	0.946	173

Table 15. S-parameter for PD55008S-E ($V_{DS} = 12.5\text{ V}$, $I_{DS} = 1.5\text{ A}$)

Freq (MHz)	$ S_{11} $	$\angle S_{11}$	$ S_{21} $	$\angle S_{21}$	$ S_{12} $	$\angle S_{12}$	$ S_{22} $	$\angle S_{22}$
50	0.821	-162	18.74	90	0.002	2	0.771	-163
100	0.849	-169	9.09	82	0.019	-5	0.776	-171
150	0.875	-171	5.97	77	0.018	-10	0.785	-173
200	0.885	-173	4.41	71	0.017	-12	0.789	-173
250	0.892	-175	3.47	66	0.017	17	0.807	-174
300	0.895	-175	2.84	61	0.016	-19	0.915	-174
350	0.901	-176	2.37	56	0.015	-22	0.924	-174
400	0.909	-177	2.02	52	0.014	-26	0.839	-174
450	0.914	-177	1.74	48	0.013	-28	0.844	-175
500	0.920	-178	1.50	43	0.013	-30	0.859	-176
550	0.928	-178	1.32	40	0.012	-28	0.871	-176
600	0.932	-179	1.17	37	0.011	-34	0.877	-176
650	0.935	-179	1.04	33	0.010	-31	0.887	-177
700	0.939	-180	0.93	30	0.009	-29	0.895	-177
750	0.946	179	0.84	28	0.008	-28	0.901	-178
800	0.946	179	0.77	25	0.008	-31	0.908	-179
850	0.953	178	0.70	22	0.007	-31	0.908	-179
900	0.952	178	0.64	19	0.006	-27	0.916	180
950	0.950	177	0.59	18	0.006	-33	0.924	179
1000	0.954	177	0.55	15	0.005	-21	0.928	178
1050	0.957	176	0.50	3	0.005	-20	0.930	178
1100	0.959	176	0.47	11	0.004	4	0.933	178
1150	0.959	175	0.44	8	0.004	13	0.937	177
1200	0.961	175	0.41	7	0.004	30	0.937	177
1250	0.962	174	0.38	5	0.003	29	0.935	176
1300	0.961	174	0.35	3	0.004	35	0.935	175
1350	0.961	174	0.33	2	0.004	55	0.935	174
1400	0.959	173	0.31	1	0.005	62	0.934	174
1450	0.960	172	0.29	0	0.005	65	0.942	173
1500	0.960	172	0.27	-1	0.005	81	0.942	173

8 Package mechanical data

In order to meet environmental requirements, ST offers these devices in different grades of ECOPACK[®] packages, depending on their level of environmental compliance. ECOPACK[®] specifications, grade definitions and product status are available at: www.st.com. ECOPACK[®] is an ST trademark.

Table 16. PowerSO-10RF formed lead (Gull Wing) mechanical data

Dim.	mm.			Inch		
	Min.	Typ.	Max.	Min.	Typ.	Max.
A1	0	0.05	0.1	0.	0.0019	0.0038
A2	3.4	3.5	3.6	0.134	0.137	0.142
A3	1.2	1.3	1.4	0.046	0.05	0.054
A4	0.15	0.2	0.25	0.005	0.007	0.009
a		0.2			0.007	
b	5.4	5.53	5.65	0.212	0.217	0.221
c	0.23	0.27	0.32	0.008	0.01	0.012
D	9.4	9.5	9.6	0.370	0.374	0.377
D1	7.4	7.5	7.6	0.290	0.295	0.298
E	13.85	14.1	14.35	0.544	0.555	0.565
E1	9.3	9.4	9.5	0.365	0.37	0.375
E2	7.3	7.4	7.5	0.286	0.292	0.294
E3	5.9	6.1	6.3	0.231	0.24	0.247
F		0.5			0.019	
G		1.2			0.047	
L	0.8	1	1.1	0.030	0.039	0.042
R1			0.25			0.01
R2		0.8			0.031	
T	2 deg	5 deg	8 deg	2 deg	5 deg	8 deg
T1		6 deg			6 deg	
T2		10 deg			10 deg	

Note: Resin protrusions not included (max value: 0.15 mm per side)

Figure 29. Package dimensions

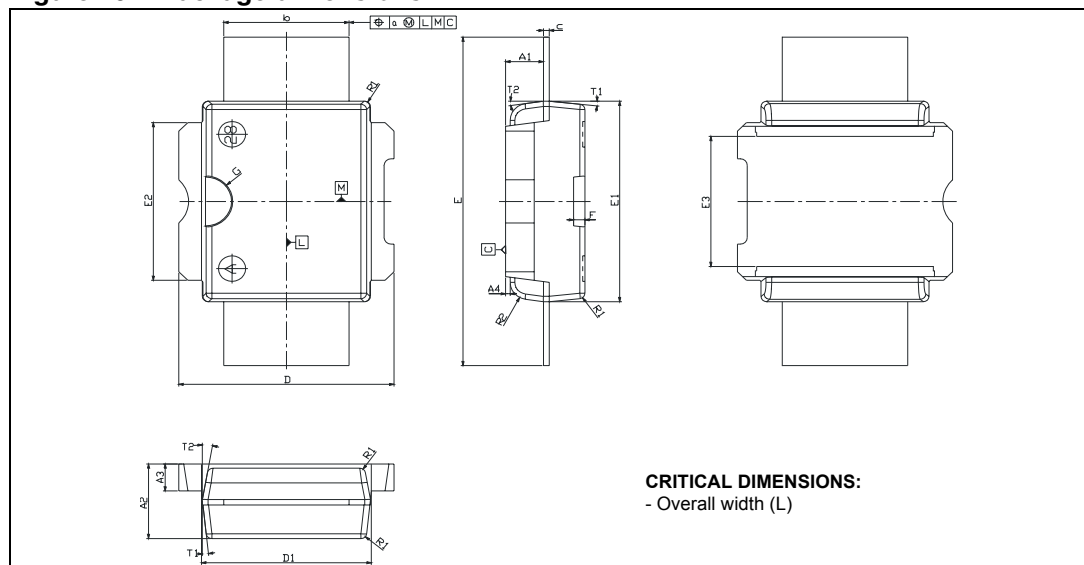

Figure 30. Tube information

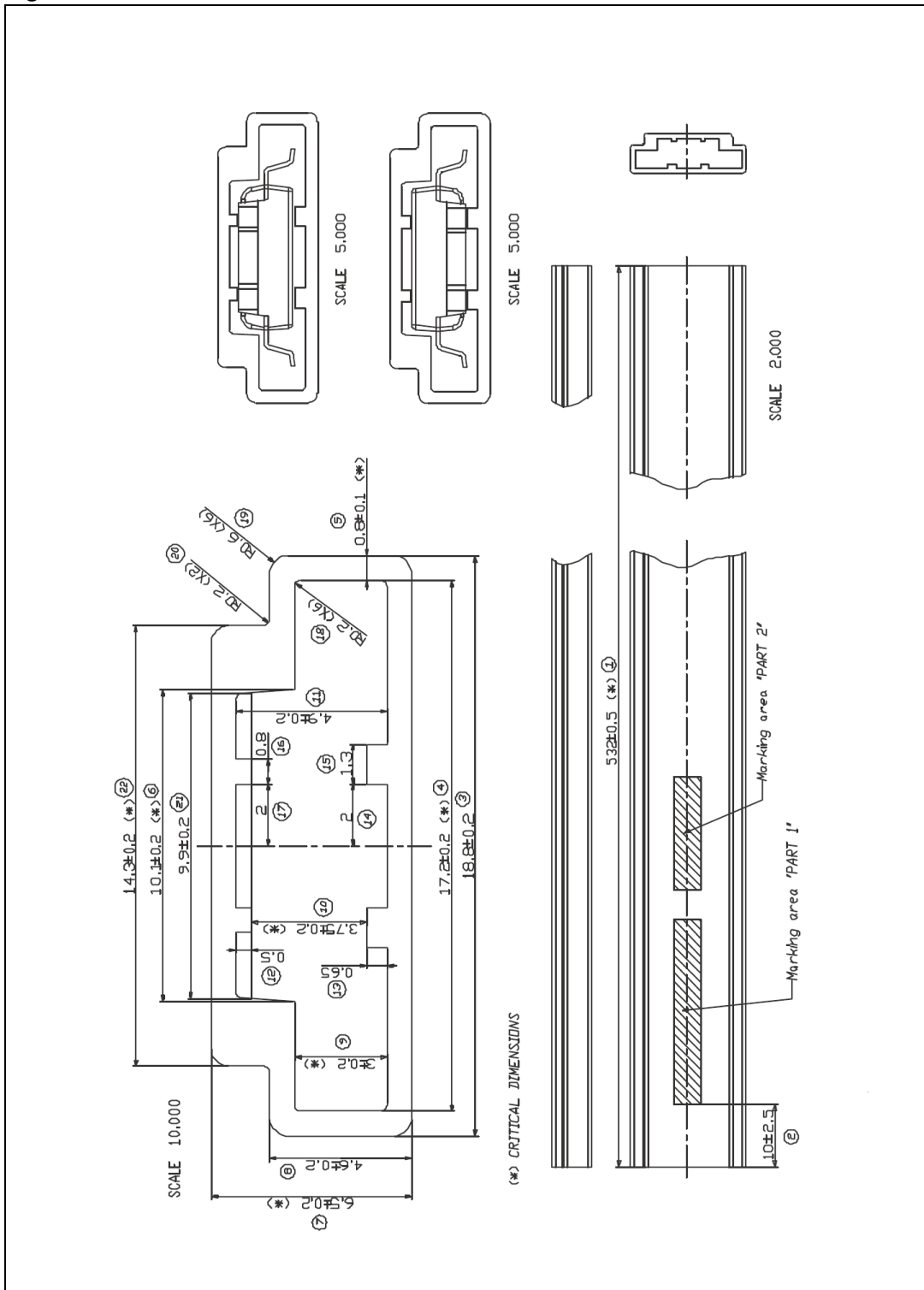
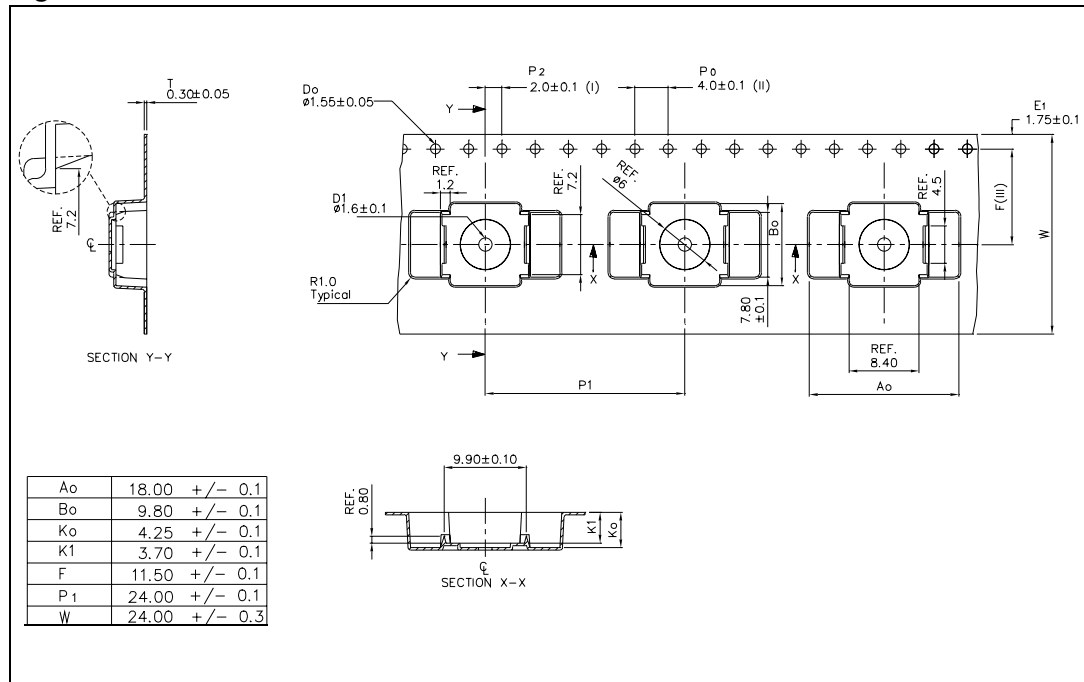

Figure 31. Reel information



9 Revision history

Table 17. Document revision history

Date	Revision	Changes
07-Apr-2006	1	Initial release.
20-May-2010	2	Added: Table 6: Moisture sensitivity level .

Please Read Carefully:

Information in this document is provided solely in connection with ST products. STMicroelectronics NV and its subsidiaries ("ST") reserve the right to make changes, corrections, modifications or improvements, to this document, and the products and services described herein at any time, without notice.

All ST products are sold pursuant to ST's terms and conditions of sale.

Purchasers are solely responsible for the choice, selection and use of the ST products and services described herein, and ST assumes no liability whatsoever relating to the choice, selection or use of the ST products and services described herein.

No license, express or implied, by estoppel or otherwise, to any intellectual property rights is granted under this document. If any part of this document refers to any third party products or services it shall not be deemed a license grant by ST for the use of such third party products or services, or any intellectual property contained therein or considered as a warranty covering the use in any manner whatsoever of such third party products or services or any intellectual property contained therein.

UNLESS OTHERWISE SET FORTH IN ST'S TERMS AND CONDITIONS OF SALE ST DISCLAIMS ANY EXPRESS OR IMPLIED WARRANTY WITH RESPECT TO THE USE AND/OR SALE OF ST PRODUCTS INCLUDING WITHOUT LIMITATION IMPLIED WARRANTIES OF MERCHANTABILITY, FITNESS FOR A PARTICULAR PURPOSE (AND THEIR EQUIVALENTS UNDER THE LAWS OF ANY JURISDICTION), OR INFRINGEMENT OF ANY PATENT, COPYRIGHT OR OTHER INTELLECTUAL PROPERTY RIGHT.

UNLESS EXPRESSLY APPROVED IN WRITING BY AN AUTHORIZED ST REPRESENTATIVE, ST PRODUCTS ARE NOT RECOMMENDED, AUTHORIZED OR WARRANTED FOR USE IN MILITARY, AIR CRAFT, SPACE, LIFE SAVING, OR LIFE SUSTAINING APPLICATIONS, NOR IN PRODUCTS OR SYSTEMS WHERE FAILURE OR MALFUNCTION MAY RESULT IN PERSONAL INJURY, DEATH, OR SEVERE PROPERTY OR ENVIRONMENTAL DAMAGE. ST PRODUCTS WHICH ARE NOT SPECIFIED AS "AUTOMOTIVE GRADE" MAY ONLY BE USED IN AUTOMOTIVE APPLICATIONS AT USER'S OWN RISK.

Resale of ST products with provisions different from the statements and/or technical features set forth in this document shall immediately void any warranty granted by ST for the ST product or service described herein and shall not create or extend in any manner whatsoever, any liability of ST.

ST and the ST logo are trademarks or registered trademarks of ST in various countries.

Information in this document supersedes and replaces all information previously supplied.

The ST logo is a registered trademark of STMicroelectronics. All other names are the property of their respective owners.

© 2010 STMicroelectronics - All rights reserved

STMicroelectronics group of companies

Australia - Belgium - Brazil - Canada - China - Czech Republic - Finland - France - Germany - Hong Kong - India - Israel - Italy - Japan - Malaysia - Malta - Morocco - Philippines - Singapore - Spain - Sweden - Switzerland - United Kingdom - United States of America

www.st.com



Mouser Electronics

Authorized Distributor

Click to View Pricing, Inventory, Delivery & Lifecycle Information:

[STMicroelectronics:](#)

[PD55008-E](#) [PD55008STR-E](#) [PD55008TR-E](#) [PD55008S-E](#)