



STB120N4F6 STD120N4F6

N-channel 40 V, 3.5 mΩ, 80 A, DPAK, D²PAK
STripFET™ VI DeepGATE™ Power MOSFET

Features

| Order codes | V _{DSS} | R _{DS(on)} max. | I _D |
|-------------|------------------|--------------------------|---------------------|
| STB120N4F6 | 40 V | 4 mΩ | 80 A ⁽¹⁾ |
| STD120N4F6 | 40 V | 4 mΩ | 80 A ⁽¹⁾ |

1. Current limited by package

- Standard threshold drive
- 100% avalanche tested

Application

- Switching applications
- Automotive

Description

These devices are 40 V N-channel STripFET™ VI Power MOSFET based on the ST's proprietary STripFET™ technology, with a new gate structure. The resulting Power MOSFET exhibits the lowest R_{DS(on)} in all packages.

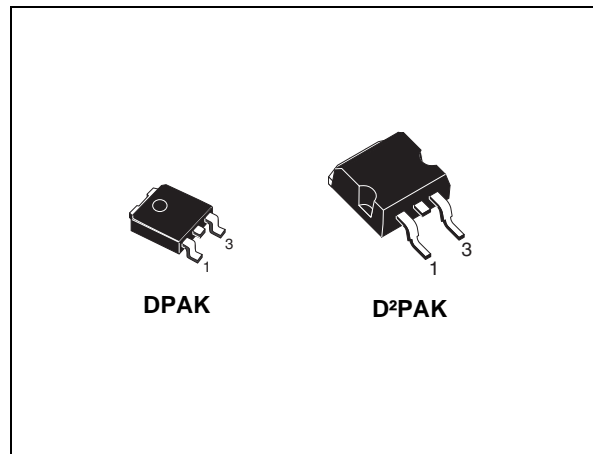

Figure 1. Internal schematic diagram

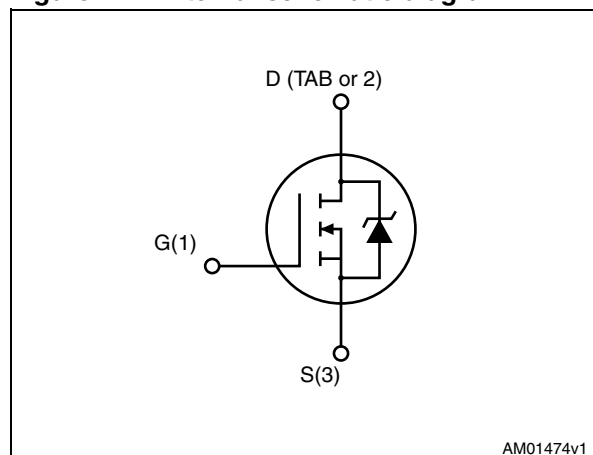

Table 1. Device summary

| Order codes | Marking | Package | Packaging |
|-------------|---------|--------------------|---------------|
| STB120N4F6 | 120N4F6 | D ² PAK | Tape and reel |
| STD120N4F6 | | DPAK | |

Contents

| | | |
|----------|---|-----------|
| 1 | Electrical ratings | 3 |
| 2 | Electrical characteristics | 4 |
| 2.1 | Electrical characteristics (curves) | 6 |
| 3 | Test circuits | 8 |
| 4 | Package mechanical data | 10 |
| 5 | Packaging mechanical data | 15 |
| 6 | Revision history | 18 |

1 Electrical ratings

Table 2. Absolute maximum ratings

| Symbol | Parameter | Value | Unit |
|----------------|---|------------|------------------|
| V_{DS} | Drain-source voltage ($V_{GS} = 0$) | 40 | V |
| V_{GS} | Gate-source voltage | ± 20 | V |
| $I_D^{(1)}$ | Drain current (continuous) at $T_C = 25\text{ }^\circ\text{C}$ | 80 | A |
| $I_D^{(1)}$ | Drain current (continuous) at $T_C = 100\text{ }^\circ\text{C}$ | 80 | A |
| $I_{DM}^{(2)}$ | Drain current (pulsed) | 320 | A |
| P_{TOT} | Total dissipation at $T_C = 25\text{ }^\circ\text{C}$ | 110 | W |
| T_{stg} | Storage temperature | -55 to 175 | $^\circ\text{C}$ |
| T_j | Operating junction temperature | | |

1. Current limited by package
2. Pulse width limited by safe operating area

Table 3. Thermal resistance

| Symbol | Parameter | Value | | Unit |
|----------------|--|-------|--------------------|---------------------------|
| | | DPAK | D ² PAK | |
| $R_{thj-case}$ | Thermal resistance junction-case max | 1.36 | | $^\circ\text{C}/\text{W}$ |
| $R_{thj-pcb}$ | Thermal resistance junction-pcb max ⁽¹⁾ | 50 | 35 | $^\circ\text{C}/\text{W}$ |

1. When mounted on 1 inch² 2 oz. Cu board.

Table 4. Thermal resistance

| Symbol | Parameter | Value | Unit |
|----------------|---|-------|------|
| $I_{AR}^{(1)}$ | Avalanche current, repetitive or not-repetitive | 40 | A |
| $E_{AS}^{(2)}$ | Single pulse avalanche energy | 394 | mJ |

1. Pulse width limited by T_j max
2. Starting $T_j = 25\text{ }^\circ\text{C}$, $I_D = 40\text{ A}$, $V_{DD} = 25\text{ V}$

2 Electrical characteristics

($T_{CASE} = 25\text{ °C}$ unless otherwise specified)

Table 5. Static

| Symbol | Parameter | Test conditions | Min. | Typ. | Max. | Unit |
|---------------|--|--|------|------|-----------|--------------------------------|
| $V_{(BR)DSS}$ | Drain-source breakdown Voltage | $I_D = 250\ \mu\text{A}$, $V_{GS} = 0$ | 40 | | | V |
| I_{DSS} | Zero gate voltage drain current ($V_{GS} = 0$) | $V_{DS} = 20\text{ V}$ $V_{DS} = 20\text{ V}$, $T_c = 125\text{ °C}$ | | | 1 10 | μA μA |
| I_{GSS} | Gate body leakage current ($V_{DS} = 0$) | $V_{GS} = \pm 20\text{ V}$ | | | ± 100 | nA |
| $V_{GS(th)}$ | Gate threshold voltage | $V_{DS} = V_{GS}$, $I_D = 250\ \mu\text{A}$ | 2 | | 4 | V |
| $R_{DS(on)}$ | Static drain-source on resistance | $V_{GS} = 10\text{ V}$, $I_D = 40\text{ A}$ | | 3.5 | 4.0 | m Ω |

Table 6. Dynamic

| Symbol | Parameter | Test conditions | Min | Typ. | Max. | Unit |
|-----------|------------------------------|--|-----|------|------|----------|
| C_{iss} | Input capacitance | $V_{DS} = 25\text{ V}$, $f = 1\text{ MHz}$, $V_{GS} = 0\text{ V}$ | | 3850 | | pF |
| C_{oss} | Output capacitance | | - | 650 | - | pF |
| C_{rss} | Reverse transfer capacitance | | | | 350 | pF |
| Q_g | Total gate charge | $V_{DD} = 20\text{ V}$, $I_D = 80\text{ A}$ | | 65 | | nC |
| Q_{gs} | Gate-source charge | $V_{GS} = 10\text{ V}$ | - | 20 | - | nC |
| Q_{gd} | Gate-drain charge | (see Figure 14) | | 16 | | nC |
| R_G | Intrinsic gate resistance | $f = 1\text{ MHz}$ open drain | - | 1.5 | - | Ω |

Table 7. Switching on/off (inductive load)

| Symbol | Parameter | Test conditions | Min. | Typ. | Max. | Unit |
|--------------|---------------------|--|------|------|------|------|
| $t_{d(on)}$ | Turn-on delay time | $V_{DD} = 20\text{ V}$, $I_D = 40\text{ A}$, $R_G = 4.7\ \Omega$, $V_{GS} = 10\text{ V}$ <i>(see Figure 15)</i> | - | 20 | - | ns |
| t_r | Rise time | | - | 70 | - | ns |
| $t_{d(off)}$ | Turn-off delay time | $V_{DD} = 20\text{ V}$, $I_D = 40\text{ A}$, $R_G = 4.7\ \Omega$, $V_{GS} = 10\text{ V}$ <i>(see Figure 15)</i> | - | 40 | - | ns |
| t_f | Fall time | | - | 20 | - | ns |

Table 8. Source drain diode

| Symbol | Parameter | Test conditions | Min. | Typ. | Max. | Unit |
|-----------------|-------------------------------|--|------|------|------|------|
| I_{SD} | Source-drain current | | - | | 80 | A |
| $I_{SDM}^{(1)}$ | Source-drain current (pulsed) | | - | | 320 | A |
| $V_{SD}^{(2)}$ | Forward on voltage | $I_{SD} = 40\text{ A}$, $V_{GS} = 0$ | - | | 1.1 | V |
| t_{rr} | Reverse recovery time | $I_{SD} = 80\text{ A}$, $di/dt = 100\text{ A}/\mu\text{s}$, $V_{DD} = 30\text{ V}$ <i>(see Figure 17)</i> | - | 40 | | ns |
| Q_{rr} | Reverse recovery charge | | - | 56 | | nC |
| I_{RRM} | Reverse recovery current | | - | 2.8 | | A |

1. Pulse width limited by safe operating area
2. Pulsed: pulse duration = 300 μs , duty cycle 1.5%

2.1 Electrical characteristics (curves)

Figure 2. Safe operating area

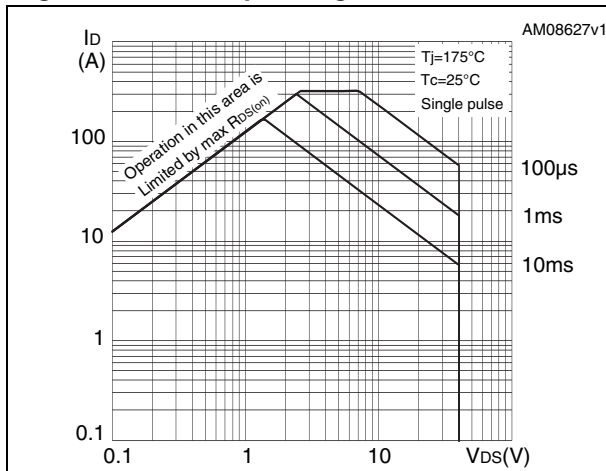

Figure 3. Thermal impedance

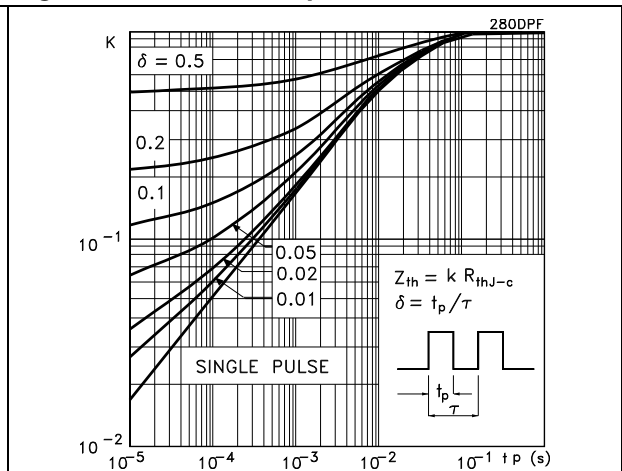

Figure 4. Output characteristics

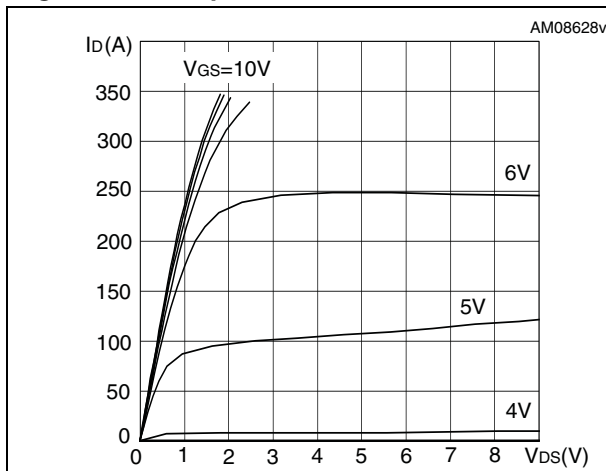

Figure 5. Transfer characteristics

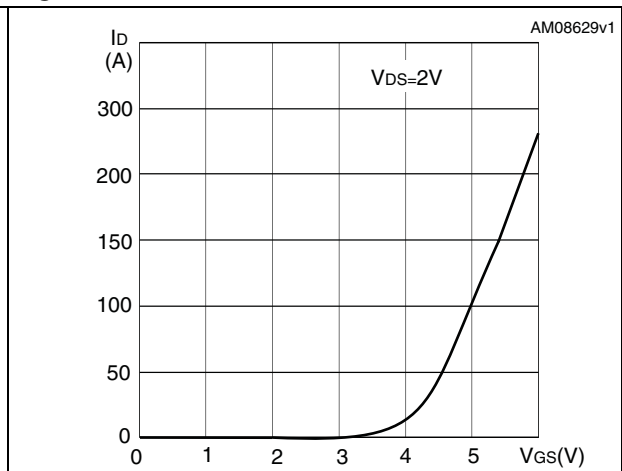

Figure 6. Normalized $B_{V_{DS}}$ vs temperature

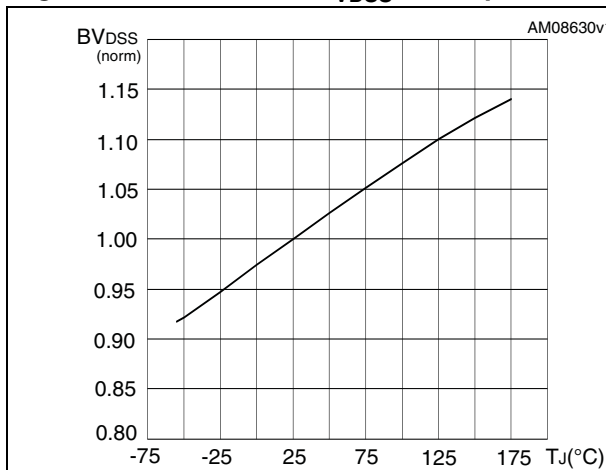

Figure 7. Static drain-source on resistance

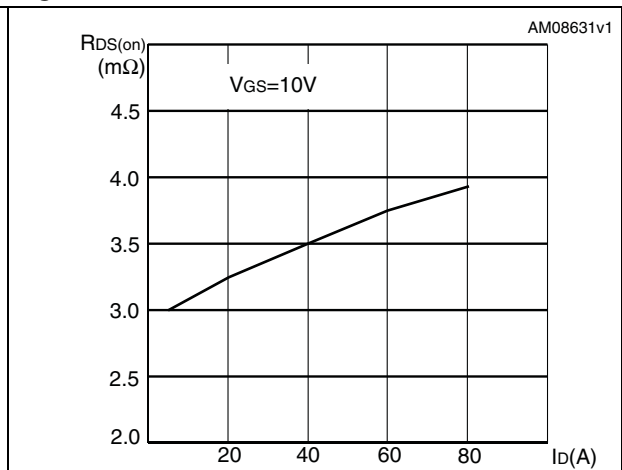

Figure 8. Gate charge vs gate-source voltage **Figure 9. Capacitance variations**

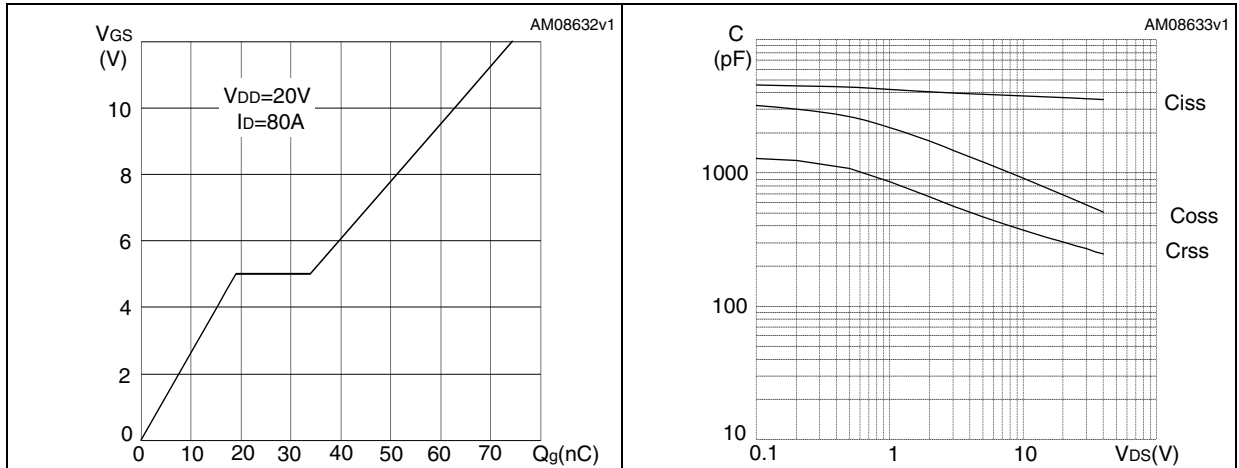

Figure 10. Normalized gate threshold voltage vs temperature **Figure 11. Normalized on resistance vs temperature**

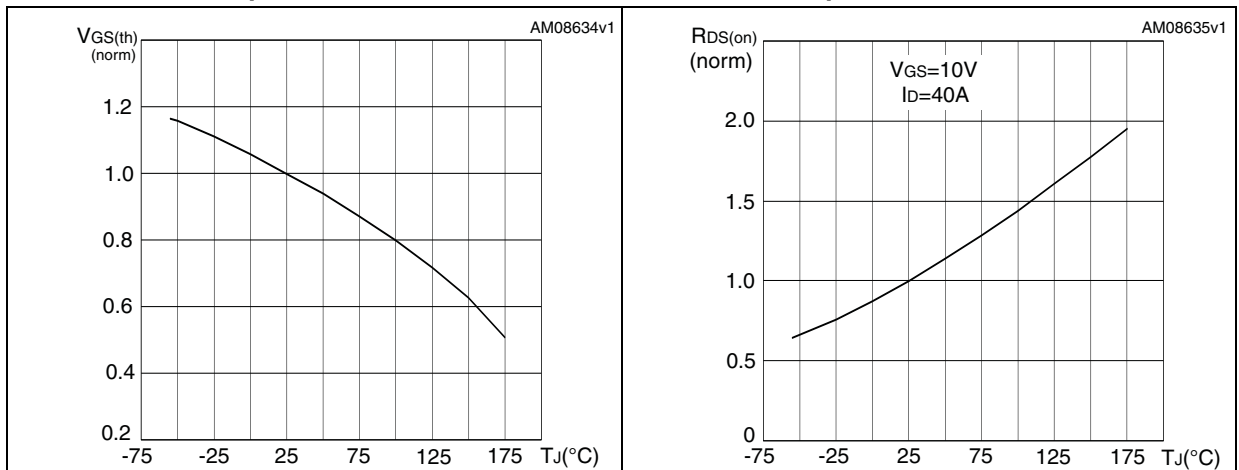
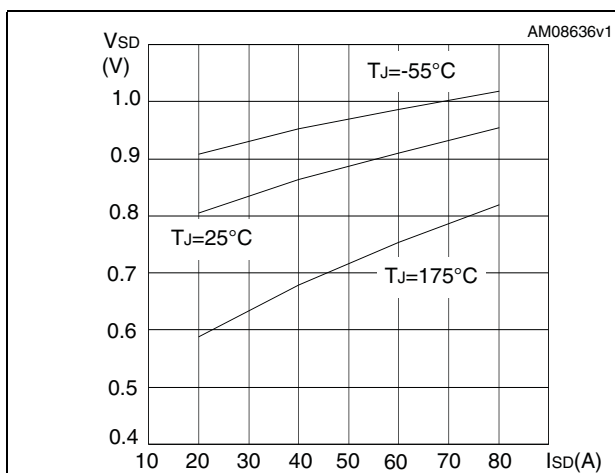

Figure 12. Source-drain diode forward characteristics



3 Test circuits

Figure 13. Switching times test circuit for resistive load



Figure 14. Gate charge test circuit



Figure 15. Test circuit for inductive load switching and diode recovery times



Figure 16. Unclamped Inductive load test circuit



Figure 17. Unclamped inductive waveform

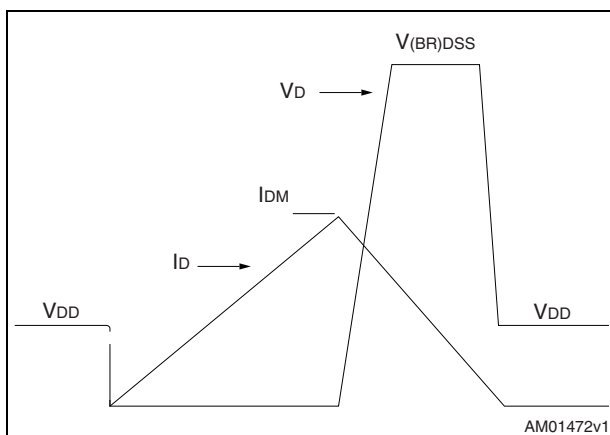
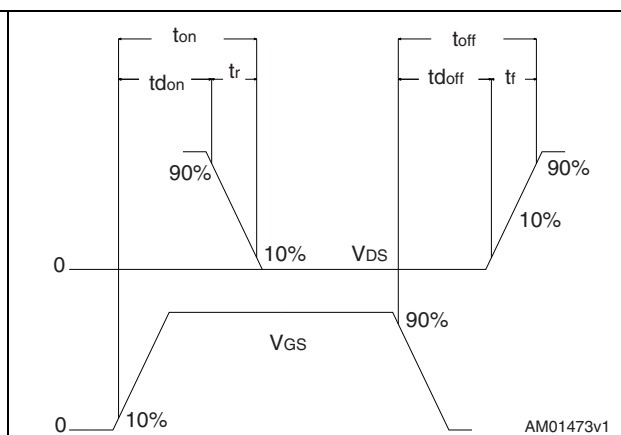

Figure 18. Switching time waveform



4 Package mechanical data

In order to meet environmental requirements, ST offers these devices in different grades of ECOPACK® packages, depending on their level of environmental compliance. ECOPACK specifications, grade definitions and products status are available at: www.st.com. ECOPACK is an ST trademark.

Table 9. D²PAK (TO-263) mechanical data

| Dim. | mm | | |
|------|------|------|-------|
| | Min. | Typ. | Max. |
| A | 4.40 | | 4.60 |
| A1 | 0.03 | | 0.23 |
| b | 0.70 | | 0.93 |
| b2 | 1.14 | | 1.70 |
| c | 0.45 | | 0.60 |
| c2 | 1.23 | | 1.36 |
| D | 8.95 | | 9.35 |
| D1 | 7.50 | | |
| E | 10 | | 10.40 |
| E1 | 8.50 | | |
| e | | 2.54 | |
| e1 | 4.88 | | 5.28 |
| H | 15 | | 15.85 |
| J1 | 2.49 | | 2.69 |
| L | 2.29 | | 2.79 |
| L1 | 1.27 | | 1.40 |
| L2 | 1.30 | | 1.75 |
| R | | 0.4 | |
| V2 | 0° | | 8° |

Figure 19. D²PAK footprint^(a)

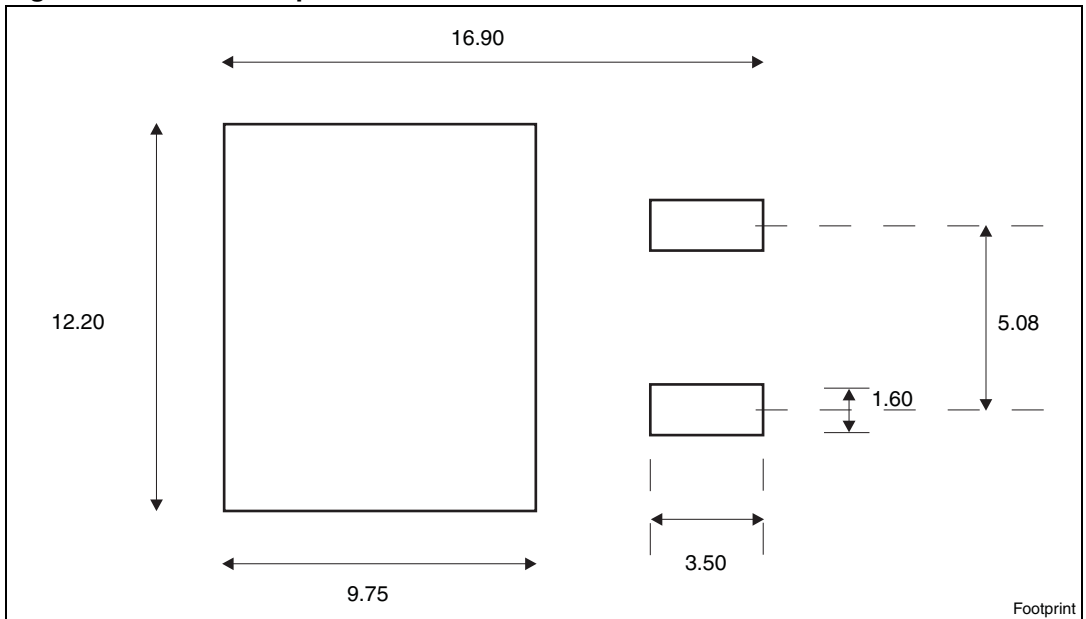
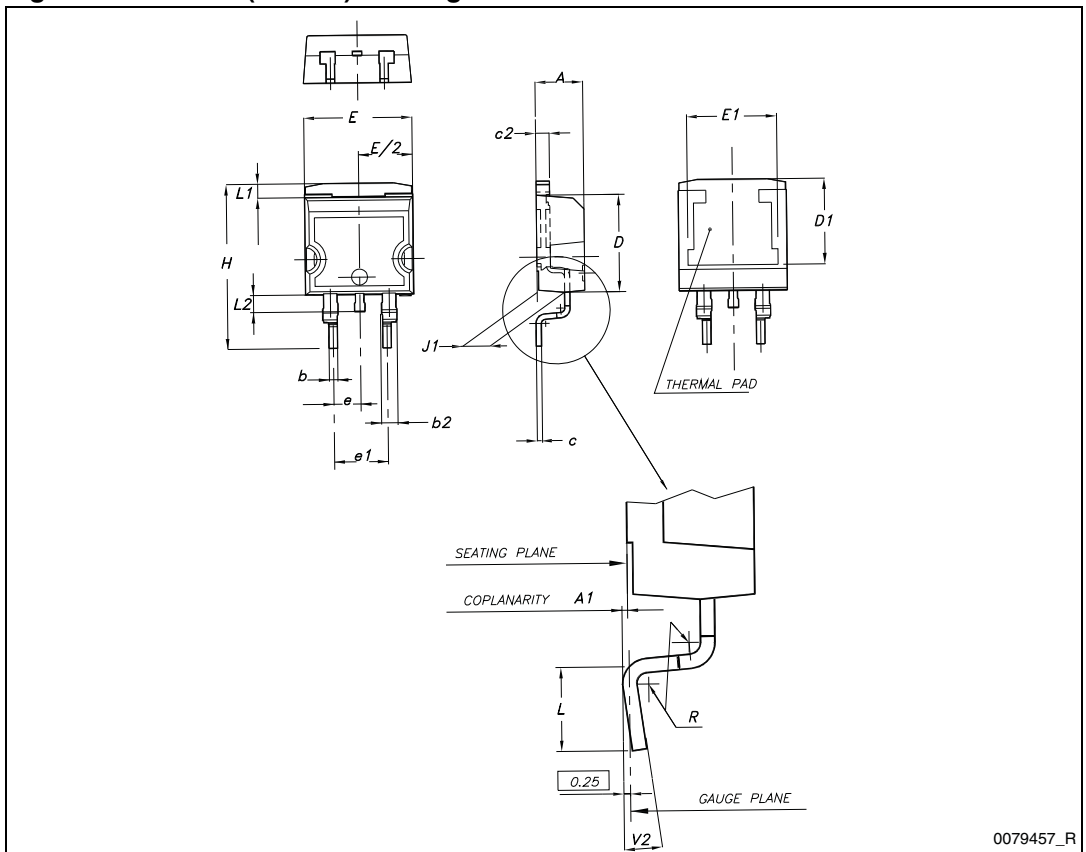

Figure 20. D²PAK (TO-263) drawing



a. All dimension are in millimeters

Table 10. DPAK (TO-252) mechanical data

| Dim. | mm | | |
|------|------|------|-------|
| | Min. | Typ. | Max. |
| A | 2.20 | | 2.40 |
| A1 | 0.90 | | 1.10 |
| A2 | 0.03 | | 0.23 |
| b | 0.64 | | 0.90 |
| b4 | 5.20 | | 5.40 |
| c | 0.45 | | 0.60 |
| c2 | 0.48 | | 0.60 |
| D | 6.00 | | 6.20 |
| D1 | | 5.10 | |
| E | 6.40 | | 6.60 |
| E1 | | 4.70 | |
| e | | 2.28 | |
| e1 | 4.40 | | 4.60 |
| H | 9.35 | | 10.10 |
| L | 1 | | 1.50 |
| L1 | | 2.80 | |
| L2 | | 0.80 | |
| L4 | 0.60 | | 1 |
| R | | 0.20 | |
| V2 | 0° | | 8° |

Figure 21. DPAK footprint^(b)

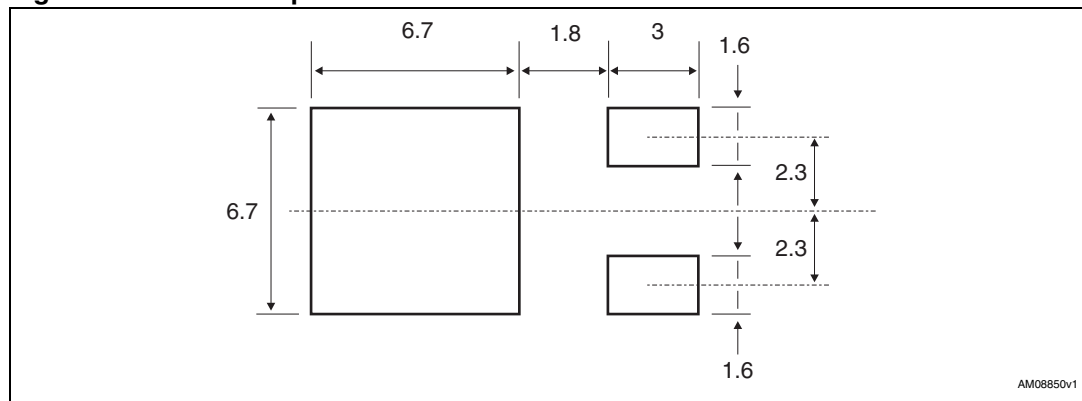

b. All dimension are in millimeters

Figure 22. DPAK (TO-252) drawing

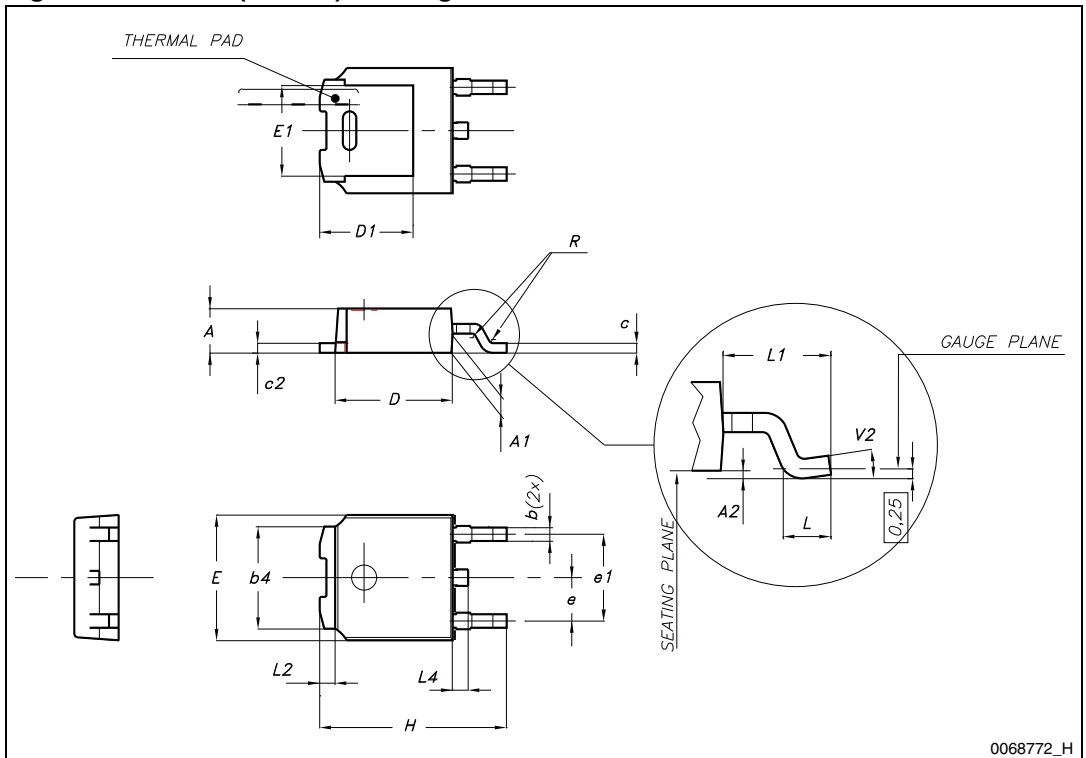

5 Packaging mechanical data

Table 11. D²PAK (TO-263) tape and reel mechanical data

| Tape | | | Reel | | |
|------|------|------|------|----------|------|
| Dim. | mm | | Dim. | mm | |
| | Min. | Max. | | Min. | Max. |
| A0 | 10.5 | 10.7 | A | | 330 |
| B0 | 15.7 | 15.9 | B | 1.5 | |
| D | 1.5 | 1.6 | C | 12.8 | 13.2 |
| D1 | 1.59 | 1.61 | D | 20.2 | |
| E | 1.65 | 1.85 | G | 24.4 | 26.4 |
| F | 11.4 | 11.6 | N | 100 | |
| K0 | 4.8 | 5.0 | T | | 30.4 |
| P0 | 3.9 | 4.1 | | | |
| P1 | 11.9 | 12.1 | | Base qty | 1000 |
| P2 | 1.9 | 2.1 | | Bulk qty | 1000 |
| R | 50 | | | | |
| T | 0.25 | 0.35 | | | |
| W | 23.7 | 24.3 | | | |

Table 12. DPAK (TO-252) tape and reel mechanical data

| Tape | | | Reel | | |
|------|------|------|-----------|------|------|
| Dim. | mm | | Dim. | mm | |
| | Min. | Max. | | Min. | Max. |
| A0 | 6.8 | 7 | A | | 330 |
| B0 | 10.4 | 10.6 | B | 1.5 | |
| B1 | | 12.1 | C | 12.8 | 13.2 |
| D | 1.5 | 1.6 | D | 20.2 | |
| D1 | 1.5 | | G | 16.4 | 18.4 |
| E | 1.65 | 1.85 | N | 50 | |
| F | 7.4 | 7.6 | T | | 22.4 |
| K0 | 2.55 | 2.75 | | | |
| P0 | 3.9 | 4.1 | Base qty. | | 2500 |
| P1 | 7.9 | 8.1 | Bulk qty. | | 2500 |
| P2 | 1.9 | 2.1 | | | |
| R | 40 | | | | |
| T | 0.25 | 0.35 | | | |
| W | 15.7 | 16.3 | | | |

Figure 23. Tape for DPAK (TO-252) and D²PAK (TO-263)

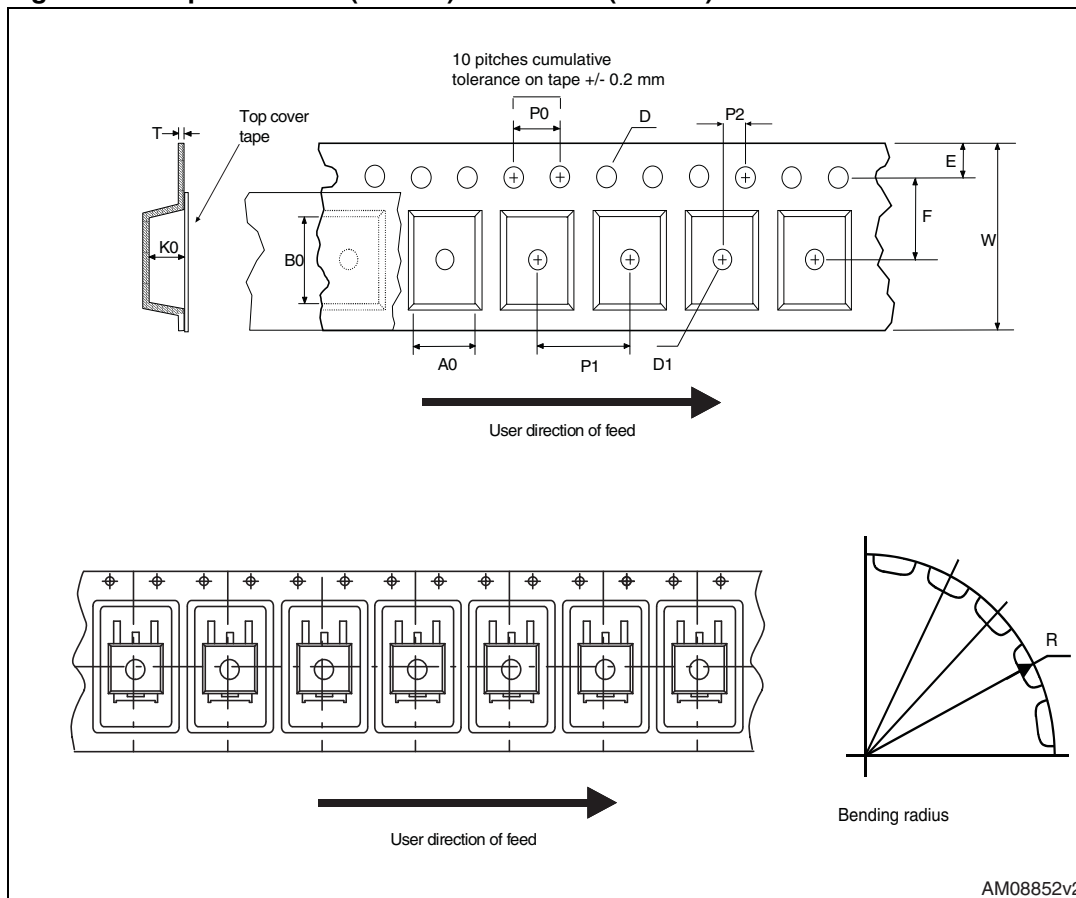

AM08852v2

Figure 24. Reel for DPAK (TO-252) and D²PAK (TO-263)

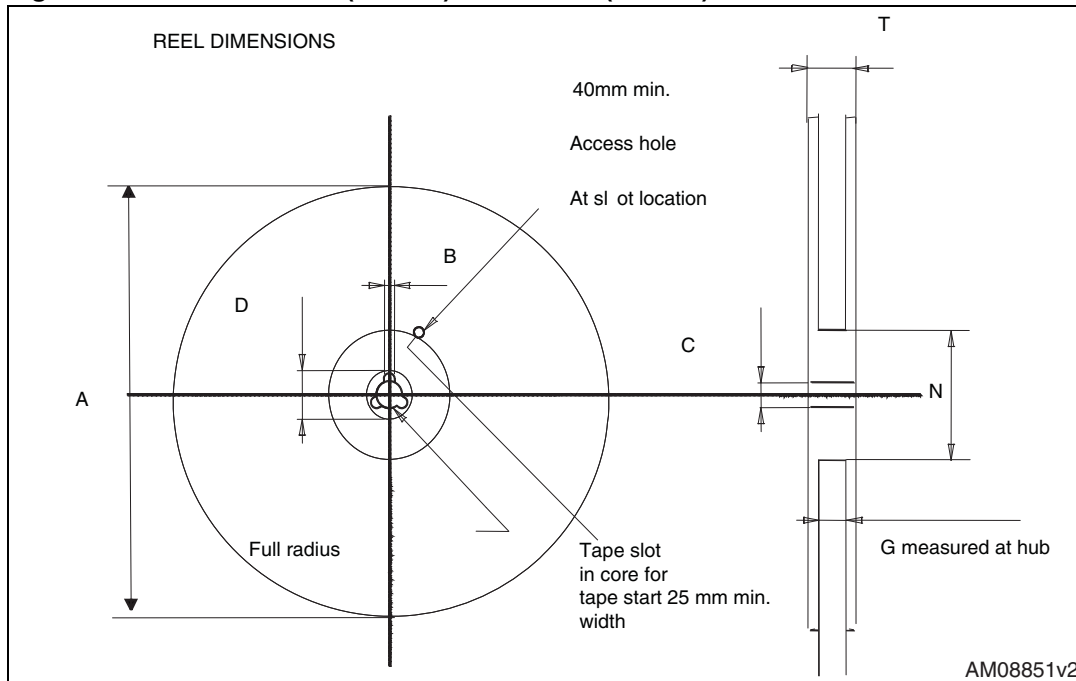

AM08851v2

6 Revision history

Table 13. Document revision history

| Date | Revision | Changes |
|-------------|----------|---|
| 09-Feb-2010 | 1 | First release |
| 29-Oct-2010 | 2 | Document status promoted from preliminary data to datasheet. |
| 11-Nov-2010 | 3 | Corrected $R_{DS(on)}$ value in Table 5: Static . |
| 13-May-2011 | 4 | Removed package and mechanical data: TO-220 |
| 17-May-2011 | 5 | Description in cover page has been updated. |

Please Read Carefully:

Information in this document is provided solely in connection with ST products. STMicroelectronics NV and its subsidiaries ("ST") reserve the right to make changes, corrections, modifications or improvements, to this document, and the products and services described herein at any time, without notice.

All ST products are sold pursuant to ST's terms and conditions of sale.

Purchasers are solely responsible for the choice, selection and use of the ST products and services described herein, and ST assumes no liability whatsoever relating to the choice, selection or use of the ST products and services described herein.

No license, express or implied, by estoppel or otherwise, to any intellectual property rights is granted under this document. If any part of this document refers to any third party products or services it shall not be deemed a license grant by ST for the use of such third party products or services, or any intellectual property contained therein or considered as a warranty covering the use in any manner whatsoever of such third party products or services or any intellectual property contained therein.

UNLESS OTHERWISE SET FORTH IN ST'S TERMS AND CONDITIONS OF SALE ST DISCLAIMS ANY EXPRESS OR IMPLIED WARRANTY WITH RESPECT TO THE USE AND/OR SALE OF ST PRODUCTS INCLUDING WITHOUT LIMITATION IMPLIED WARRANTIES OF MERCHANTABILITY, FITNESS FOR A PARTICULAR PURPOSE (AND THEIR EQUIVALENTS UNDER THE LAWS OF ANY JURISDICTION), OR INFRINGEMENT OF ANY PATENT, COPYRIGHT OR OTHER INTELLECTUAL PROPERTY RIGHT.

UNLESS EXPRESSLY APPROVED IN WRITING BY AN AUTHORIZED ST REPRESENTATIVE, ST PRODUCTS ARE NOT RECOMMENDED, AUTHORIZED OR WARRANTED FOR USE IN MILITARY, AIR CRAFT, SPACE, LIFE SAVING, OR LIFE SUSTAINING APPLICATIONS, NOR IN PRODUCTS OR SYSTEMS WHERE FAILURE OR MALFUNCTION MAY RESULT IN PERSONAL INJURY, DEATH, OR SEVERE PROPERTY OR ENVIRONMENTAL DAMAGE. ST PRODUCTS WHICH ARE NOT SPECIFIED AS "AUTOMOTIVE GRADE" MAY ONLY BE USED IN AUTOMOTIVE APPLICATIONS AT USER'S OWN RISK.

Resale of ST products with provisions different from the statements and/or technical features set forth in this document shall immediately void any warranty granted by ST for the ST product or service described herein and shall not create or extend in any manner whatsoever, any liability of ST.

ST and the ST logo are trademarks or registered trademarks of ST in various countries.

Information in this document supersedes and replaces all information previously supplied.

The ST logo is a registered trademark of STMicroelectronics. All other names are the property of their respective owners.

© 2011 STMicroelectronics - All rights reserved

STMicroelectronics group of companies

Australia - Belgium - Brazil - Canada - China - Czech Republic - Finland - France - Germany - Hong Kong - India - Israel - Italy - Japan - Malaysia - Malta - Morocco - Philippines - Singapore - Spain - Sweden - Switzerland - United Kingdom - United States of America

www.st.com

Mouser Electronics

Authorized Distributor

Click to View Pricing, Inventory, Delivery & Lifecycle Information:

[STMicroelectronics:](#)

[STB120N4F6](#) [STD120N4F6](#)