



STGF30NC60S STGP30NC60S, STGWF30NC60S

30 A, 600 V, fast IGBT

Features

- Optimized performance for medium operating frequencies up to 5 kHz in hard switching
- Low on-voltage drop ($V_{CE(sat)}$)
- High current capability

Application

Motor drive

Description

This device utilizes the advanced PowerMESH™ process resulting in an excellent trade-off between switching performance and low on-state behavior.

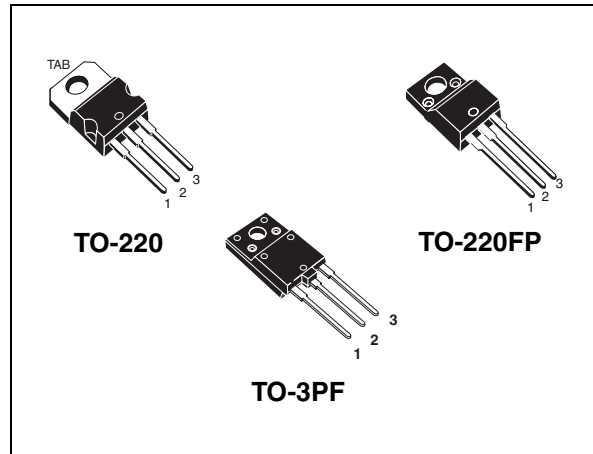

Figure 1. Internal schematic diagram

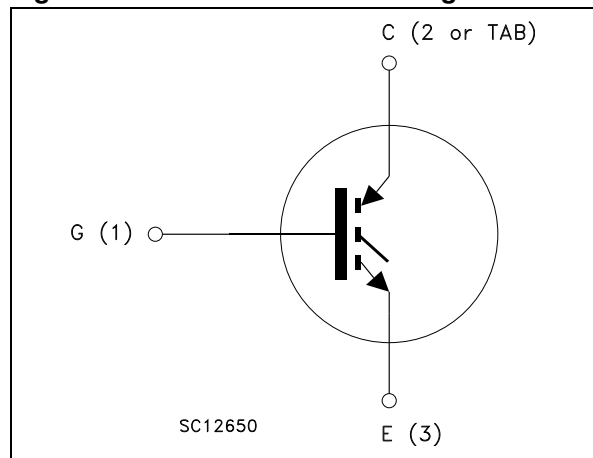

Table 1. Device summary

| Order codes | Marking | Package | Packaging |
|--------------|------------|----------|-----------|
| STGF30NC60S | GF30NC60S | TO-220FP | Tube |
| STGP30NC60S | GP30NC60S | TO-220 | |
| STGWF30NC60S | GWF30NC60S | TO-3PF | |

Contents

| | | |
|----------|---|-----------|
| 1 | Electrical ratings | 3 |
| 2 | Electrical characteristics | 4 |
| | 2.1 Electrical characteristics (curves) | 6 |
| 3 | Test circuits | 9 |
| 4 | Package mechanical data | 10 |
| 5 | Revision history | 14 |

1 Electrical ratings

Table 2. Absolute maximum ratings

| Symbol | Parameter | Value | | | Unit |
|--------------------------------|--|-------------|----------|--------|------|
| | | TO-220 | TO-220FP | TO-3PF | |
| V _{CES} | Collector-emitter voltage (V _{GE} = 0) | 600 | | | V |
| I _C ⁽¹⁾ | Continuous collector current at T _C = 25 °C | 55 | 22 | 35 | A |
| I _C ⁽¹⁾ | Continuous collector current at T _C = 100 °C | 35 | 11 | 18 | A |
| I _{CL} ⁽²⁾ | Turn-off latching current | 150 | | | A |
| I _{CP} ⁽³⁾ | Pulsed collector current | 150 | | | A |
| V _{GE} | Gate-emitter voltage | ±20 | | | V |
| V _{ISO} | Insulation withstand voltage (RMS) from all three leads to external heat sink (t=1 s; T _C =25 °C) | 2500 | | | V |
| P _{TOT} | Total dissipation at T _C = 25 °C | 175 | 40 | 79 | W |
| T _j | Operating junction temperature | - 55 to 150 | | | °C |

1. Calculated according to the iterative formula:

$$I_C(T_C) = \frac{T_{j(max)} - T_C}{R_{thj-c} \times V_{CE(sat)(max)}(T_{j(max)}, I_C(T_C))}$$

2. V_{clamp} = 80%.(V_{CES}), T_j = 150 °C, R_G = 10 Ω, V_{GE} = 15 V
 3. Pulse width limited by maximum junction temperature and turn-off within RBSOA

Table 3. Thermal data

| Symbol | Parameter | Value | | | Unit |
|-----------------------|-------------------------------------|--------|----------|--------|------|
| | | TO-220 | TO-220FP | TO-3PF | |
| R _{thj-case} | Thermal resistance junction-case | 0.7 | 3.1 | 1.58 | °C/W |
| R _{thj-amb} | Thermal resistance junction-ambient | 62.5 | | | °C/W |

2 Electrical characteristics

($T_J = 25\text{ °C}$ unless otherwise specified)

Table 4. Static

| Symbol | Parameter | Test conditions | Min. | Typ. | Max. | Unit |
|----------------|--|--|------|------------|-----------|---------------------|
| $V_{(BR)CES}$ | Collector-emitter breakdown voltage ($V_{GE} = 0$) | $I_C = 1\text{ mA}$ | 600 | | | V |
| $V_{CE(sat)}$ | Collector-emitter saturation voltage | $V_{GE} = 15\text{ V}$, $I_C = 20\text{ A}$ $V_{GE} = 15\text{ V}$, $I_C = 20\text{ A}$, $T_J = 150\text{ °C}$ | | 1.5 1.4 | 1.9 | V V |
| $V_{GE(th)}$ | Gate threshold voltage | $V_{CE} = V_{GE}$, $I_C = 250\text{ }\mu\text{A}$ | 3.75 | | 5.75 | V |
| I_{CES} | Collector cut-off current ($V_{GE} = 0$) | $V_{CE} = 600\text{ V}$ $V_{CE} = 600\text{ V}$, $T_J = 150\text{ °C}$ | | | 150 1 | μA mA |
| I_{GES} | Gate-emitter cut-off current ($V_{CE} = 0$) | $V_{GE} = \pm 20\text{ V}$ | | | ± 100 | nA |
| $g_{fs}^{(1)}$ | Forward transconductance | $V_{CE} = 15\text{ V}$, $I_C = 20\text{ A}$ | | 10 | | S |

1. Pulsed: pulse duration = 300 μs , duty cycle 1.5%

Table 5. Dynamic

| Symbol | Parameter | Test conditions | Min. | Typ. | Max. | Unit |
|-----------|------------------------------|--|------|------|------|------|
| C_{ies} | Input capacitance | $V_{CE} = 25\text{ V}$, $f = 1\text{ MHz}$, $V_{GE} = 0$ | - | 2200 | - | pF |
| C_{oes} | Output capacitance | | | 185 | | pF |
| C_{res} | Reverse transfer capacitance | | | 48.5 | | pF |
| Q_g | Total gate charge | $V_{CE} = 480\text{ V}$, $I_C = 20\text{ A}$, | - | 96 | - | nC |
| Q_{ge} | Gate-emitter charge | $V_{GE} = 15\text{ V}$ | | 14 | | nC |
| Q_{gc} | Gate-collector charge | Figure 19 | | 44.5 | | nC |

Table 6. Switching on/off (inductive load)

| Symbol | Parameter | Test conditions | Min. | Typ. | Max. | Unit |
|---|---|--|------|---------------------|------|------------------------|
| $t_{d(on)}$ t_r $(di/dt)_{on}$ | Turn-on delay time Current rise time Turn-on current slope | $V_{CC} = 480\text{ V}$, $I_C = 20\text{ A}$ $R_G = 10\ \Omega$, $V_{GE} = 15\text{ V}$ <i>Figure 18</i> | - | 21.5 8.5 2280 | - | ns ns A/ μ s |
| $t_{d(on)}$ t_r $(di/dt)_{on}$ | Turn-on delay time Current rise time Turn-on current slope | $V_{CC} = 480\text{ V}$, $I_C = 20\text{ A}$ $R_G = 10\ \Omega$, $V_{GE} = 15\text{ V}$, $T_J = 125\text{ }^\circ\text{C}$ <i>Figure 18</i> | - | 20.5 9.5 2150 | - | ns ns A/ μ s |
| $t_r(V_{off})$ $t_{d(off)}$ t_f | Off voltage rise time Turn-off delay time Current fall time | $V_{CC} = 480\text{ V}$, $I_C = 20\text{ A}$, $R_{GE} = 10\ \Omega$, $V_{GE} = 15\text{ V}$ <i>Figure 18</i> | - | 85 180 200 | - | ns ns ns |
| $t_r(V_{off})$ $t_{d(off)}$ t_f | Off voltage rise time Turn-off delay time Current fall time | $V_{CC} = 480\text{ V}$, $I_C = 20\text{ A}$, $R_{GE} = 10\ \Omega$, $V_{GE} = 15\text{ V}$ $T_J = 125\text{ }^\circ\text{C}$ <i>Figure 18</i> | - | 155 260 295 | - | ns ns ns |

Table 7. Switching energy (inductive load)

| Symbol | Parameter | Test conditions | Min. | Typ. | Max. | Unit |
|---|---|---|------|---------------------|------|-------------------------------|
| E_{on} $E_{off}^{(1)}$ E_{ts} | Turn-on switching losses Turn-off switching losses Total switching losses | $V_{CC} = 480\text{ V}$, $I_C = 20\text{ A}$ $R_G = 10\ \Omega$, $V_{GE} = 15\text{ V}$, <i>Figure 18</i> | - | 300 1275 1575 | - | μ J μ J μ J |
| E_{on} $E_{off}^{(1)}$ E_{ts} | Turn-on switching losses Turn-off switching losses Total switching losses | $V_{CC} = 480\text{ V}$, $I_C = 20\text{ A}$ $R_G = 10\ \Omega$, $V_{GE} = 15\text{ V}$, $T_J = 125\text{ }^\circ\text{C}$ <i>Figure 18</i> | - | 430 1965 2395 | - | μ J μ J μ J |

1. Turn-off losses include also the tail of the collector current.

2.1 Electrical characteristics (curves)

Figure 2. Output characteristics

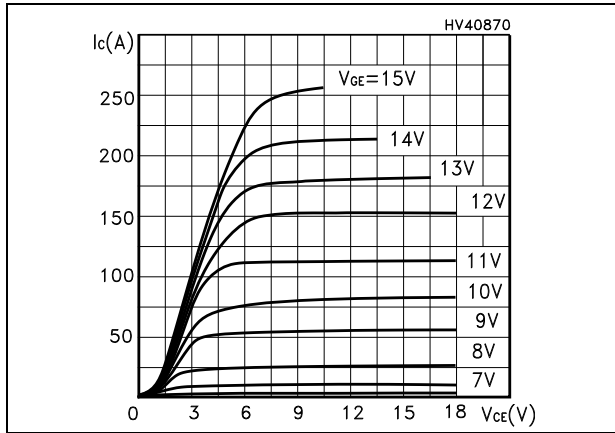

Figure 3. Transfer characteristics

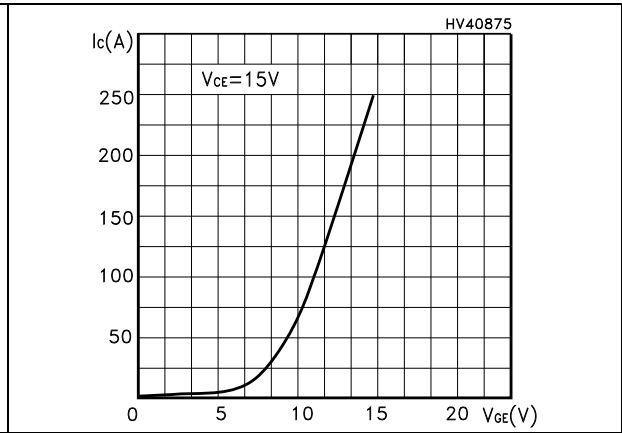

Figure 4. Transconductance

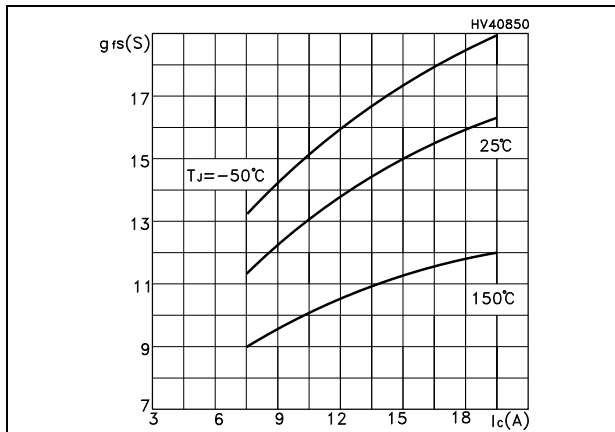

Figure 5. Collector-emitter on voltage vs temperature

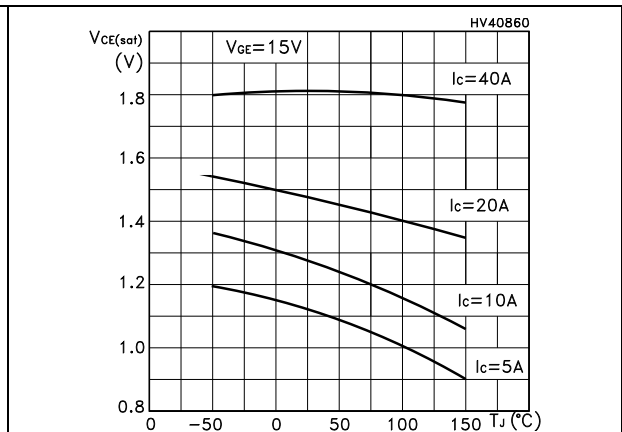

Figure 6. Gate charge vs gate-source voltage Figure 7. Capacitance variations

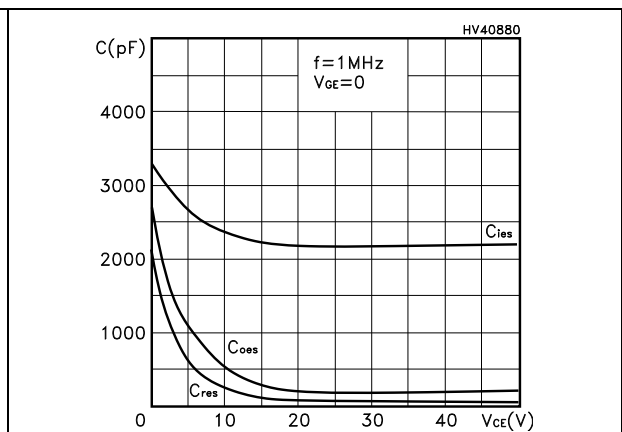
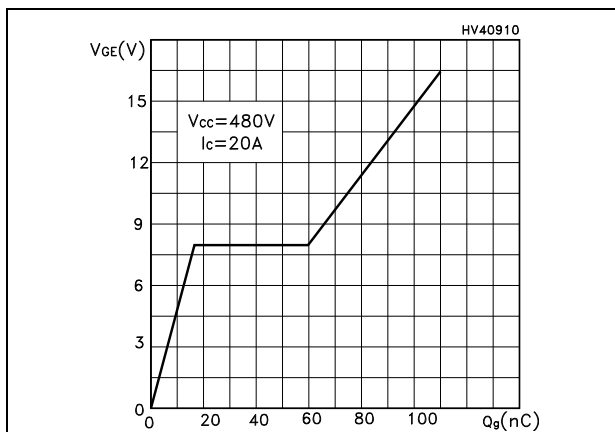

Figure 8. Normalized gate threshold voltage vs temperature

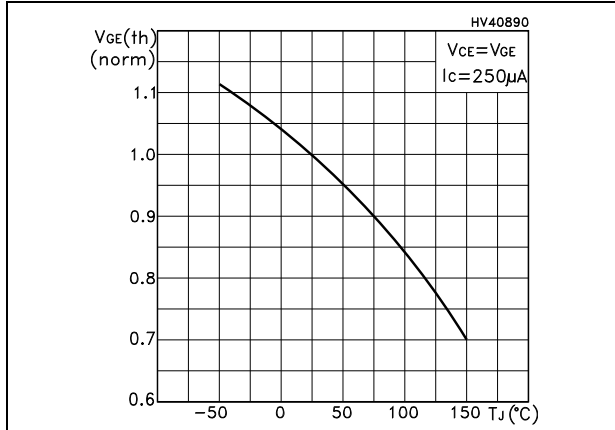

Figure 9. Collector-emitter on voltage vs collector current

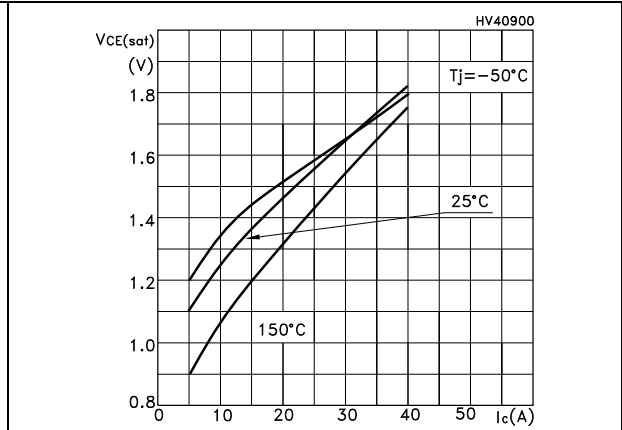

Figure 10. Normalized breakdown voltage vs temperature

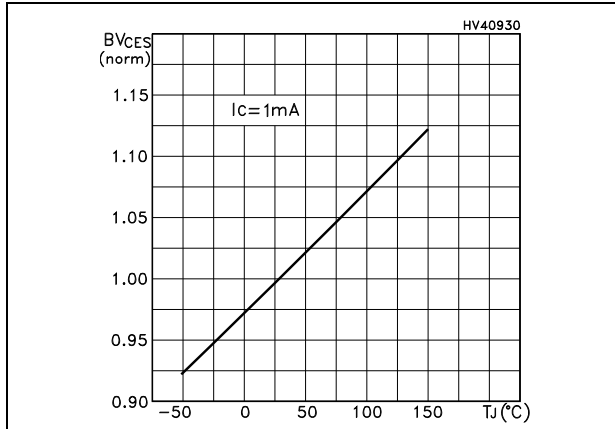

Figure 11. Switching losses vs temperature

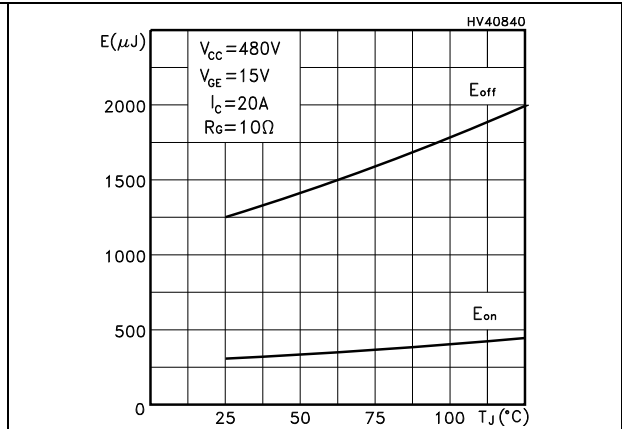

Figure 12. Switching losses vs gate resistance

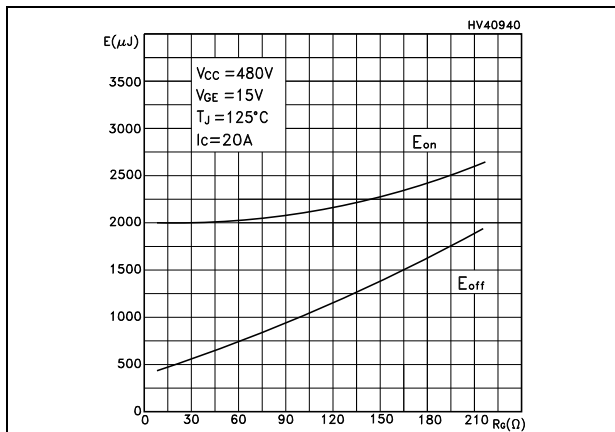

Figure 13. Switching losses vs collector current

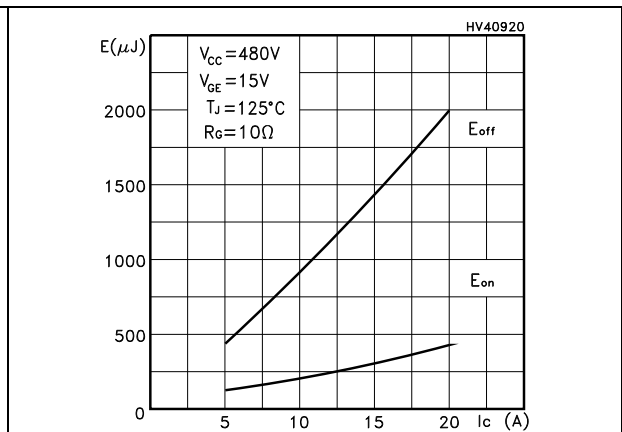

Figure 14. Thermal Impedance

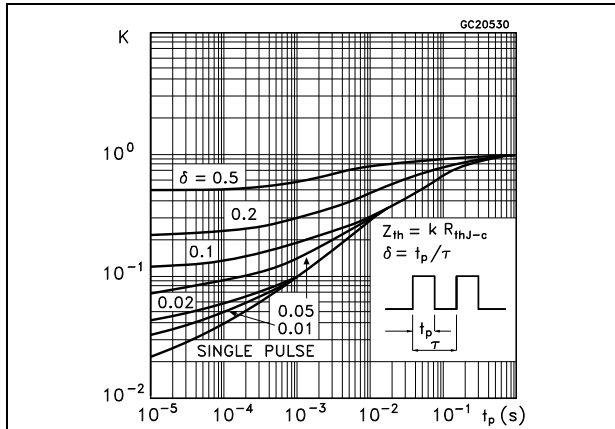

Figure 15. Turn-off SOA

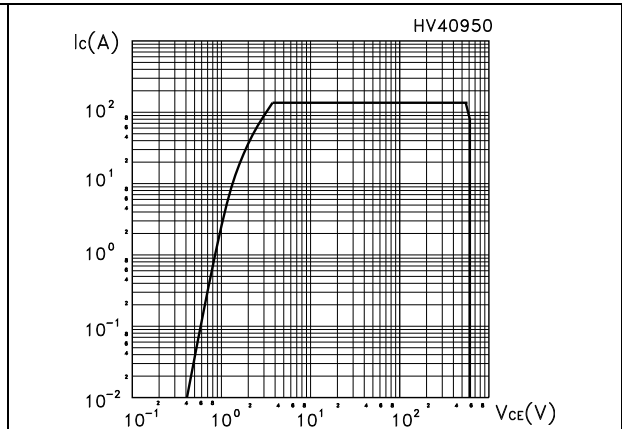

Figure 16. Thermal Impedance for TO-220FP

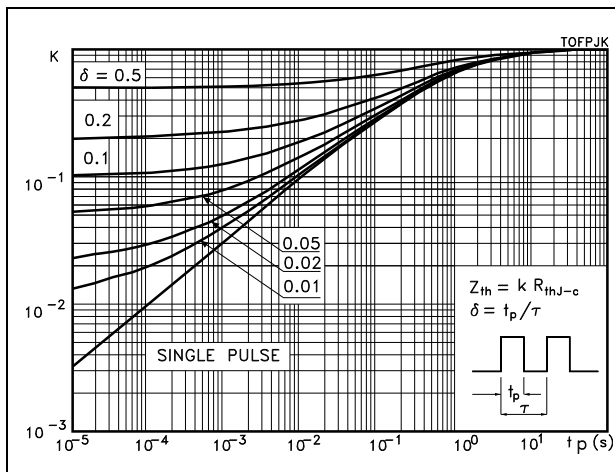
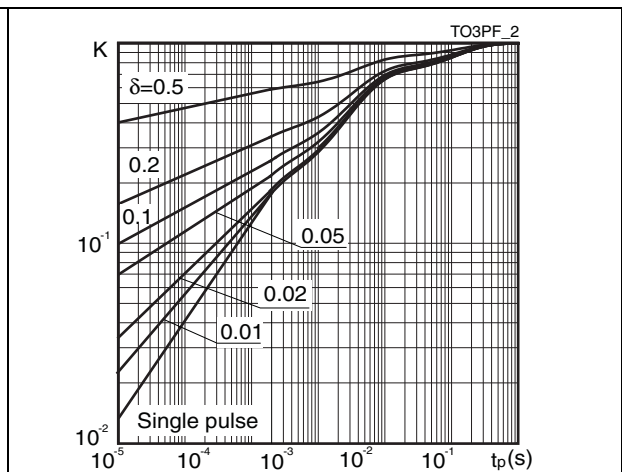

Figure 17. Thermal Impedance for TO-3PF



4 Package mechanical data

In order to meet environmental requirements, ST offers these devices in different grades of ECOPACK® packages, depending on their level of environmental compliance. ECOPACK® specifications, grade definitions and product status are available at: www.st.com. ECOPACK is an ST trademark.

Table 8. TO-220FP mechanical data

| Dim. | mm | | |
|------|------|------|------|
| | Min. | Typ. | Max. |
| A | 4.4 | | 4.6 |
| B | 2.5 | | 2.7 |
| D | 2.5 | | 2.75 |
| E | 0.45 | | 0.7 |
| F | 0.75 | | 1 |
| F1 | 1.15 | | 1.70 |
| F2 | 1.15 | | 1.70 |
| G | 4.95 | | 5.2 |
| G1 | 2.4 | | 2.7 |
| H | 10 | | 10.4 |
| L2 | | 16 | |
| L3 | 28.6 | | 30.6 |
| L4 | 9.8 | | 10.6 |
| L5 | 2.9 | | 3.6 |
| L6 | 15.9 | | 16.4 |
| L7 | 9 | | 9.3 |
| Dia | 3 | | 3.2 |

Figure 21. TO-220FP drawing

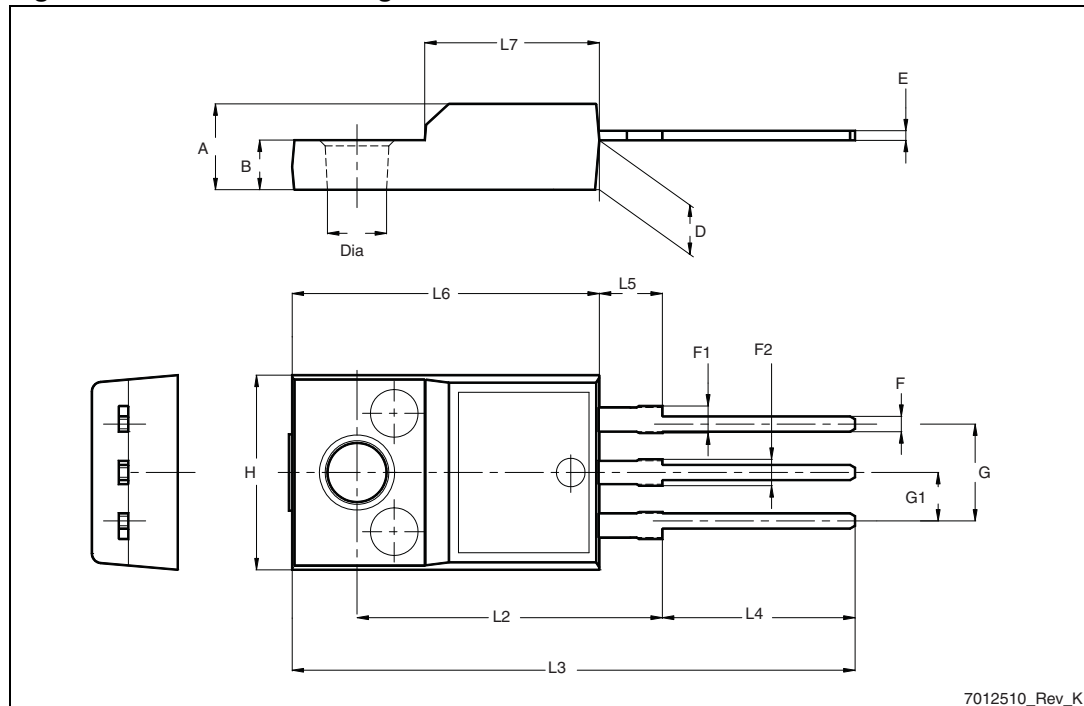

TO-220 type A mechanical data

| Dim | mm | | |
|-----|-------|-------|-------|
| | Min | Typ | Max |
| A | 4.40 | | 4.60 |
| b | 0.61 | | 0.88 |
| b1 | 1.14 | | 1.70 |
| c | 0.48 | | 0.70 |
| D | 15.25 | | 15.75 |
| D1 | | 1.27 | |
| E | 10 | | 10.40 |
| e | 2.40 | | 2.70 |
| e1 | 4.95 | | 5.15 |
| F | 1.23 | | 1.32 |
| H1 | 6.20 | | 6.60 |
| J1 | 2.40 | | 2.72 |
| L | 13 | | 14 |
| L1 | 3.50 | | 3.93 |
| L20 | | 16.40 | |
| L30 | | 28.90 | |
| ∅P | 3.75 | | 3.85 |
| Q | 2.65 | | 2.95 |

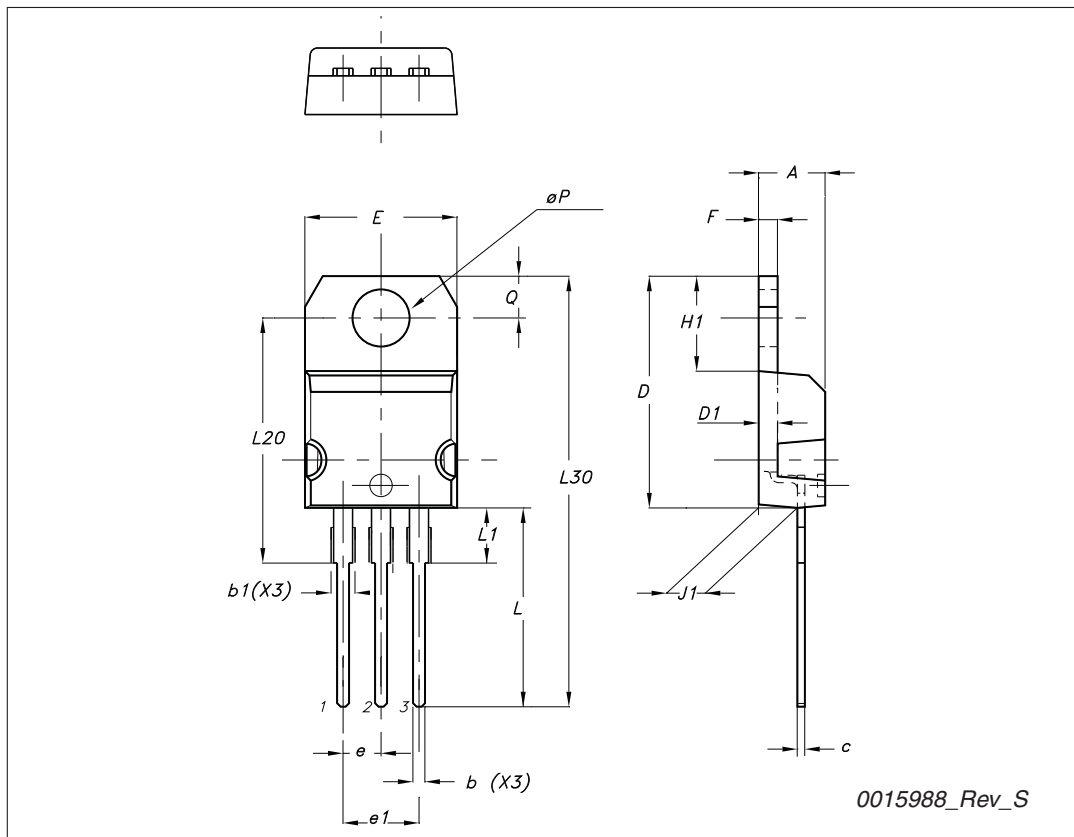

TO-3PF mechanical data

| DIM. | mm. | | |
|------|-------|------|-------|
| | min. | typ | max. |
| A | 5.30 | | 5.70 |
| C | 2.80 | | 3.20 |
| D | 3.10 | | 3.50 |
| D1 | 1.80 | | 2.20 |
| E | 0.80 | | 1.10 |
| F | 0.65 | | 0.95 |
| F2 | 1.80 | | 2.20 |
| G | 10.30 | | 11.50 |
| G1 | | 5.45 | |
| H | 15.30 | | 15.70 |
| L | 9.80 | 10 | 10.20 |
| L2 | 22.80 | | 23.20 |
| L3 | 26.30 | | 26.70 |
| L4 | 43.20 | | 44.40 |
| L5 | 4.30 | | 4.70 |
| L6 | 24.30 | | 24.70 |
| L7 | 14.60 | | 15 |
| N | 1.80 | | 2.20 |
| R | 3.80 | | 4.20 |
| Dia | 3.40 | | 3.80 |

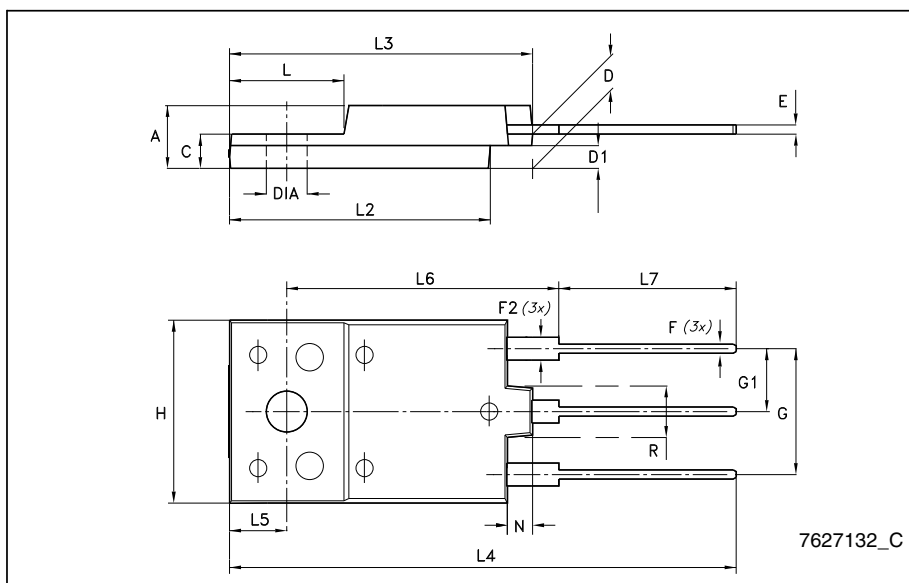

5 Revision history

Table 9. Document revision history

| Date | Revision | Changes |
|-------------|----------|---|
| 02-Jul-2007 | 1 | Initial release |
| 20-Nov-2007 | 2 | Document status promoted from preliminary data to datasheet |
| 04-May-2009 | 3 | Added new package, mechanical data: TO-220FP |
| 30-Jun-2010 | 4 | Added new package, mechanical data: TO-3PF |
| 11-Nov-2010 | 5 | <ul style="list-style-type: none">– Updated data for TO-3PF in Table 2 and Table 3– Modified Figure 17 |

Please Read Carefully:

Information in this document is provided solely in connection with ST products. STMicroelectronics NV and its subsidiaries ("ST") reserve the right to make changes, corrections, modifications or improvements, to this document, and the products and services described herein at any time, without notice.

All ST products are sold pursuant to ST's terms and conditions of sale.

Purchasers are solely responsible for the choice, selection and use of the ST products and services described herein, and ST assumes no liability whatsoever relating to the choice, selection or use of the ST products and services described herein.

No license, express or implied, by estoppel or otherwise, to any intellectual property rights is granted under this document. If any part of this document refers to any third party products or services it shall not be deemed a license grant by ST for the use of such third party products or services, or any intellectual property contained therein or considered as a warranty covering the use in any manner whatsoever of such third party products or services or any intellectual property contained therein.

UNLESS OTHERWISE SET FORTH IN ST'S TERMS AND CONDITIONS OF SALE ST DISCLAIMS ANY EXPRESS OR IMPLIED WARRANTY WITH RESPECT TO THE USE AND/OR SALE OF ST PRODUCTS INCLUDING WITHOUT LIMITATION IMPLIED WARRANTIES OF MERCHANTABILITY, FITNESS FOR A PARTICULAR PURPOSE (AND THEIR EQUIVALENTS UNDER THE LAWS OF ANY JURISDICTION), OR INFRINGEMENT OF ANY PATENT, COPYRIGHT OR OTHER INTELLECTUAL PROPERTY RIGHT.

UNLESS EXPRESSLY APPROVED IN WRITING BY AN AUTHORIZED ST REPRESENTATIVE, ST PRODUCTS ARE NOT RECOMMENDED, AUTHORIZED OR WARRANTED FOR USE IN MILITARY, AIR CRAFT, SPACE, LIFE SAVING, OR LIFE SUSTAINING APPLICATIONS, NOR IN PRODUCTS OR SYSTEMS WHERE FAILURE OR MALFUNCTION MAY RESULT IN PERSONAL INJURY, DEATH, OR SEVERE PROPERTY OR ENVIRONMENTAL DAMAGE. ST PRODUCTS WHICH ARE NOT SPECIFIED AS "AUTOMOTIVE GRADE" MAY ONLY BE USED IN AUTOMOTIVE APPLICATIONS AT USER'S OWN RISK.

Resale of ST products with provisions different from the statements and/or technical features set forth in this document shall immediately void any warranty granted by ST for the ST product or service described herein and shall not create or extend in any manner whatsoever, any liability of ST.

ST and the ST logo are trademarks or registered trademarks of ST in various countries.

Information in this document supersedes and replaces all information previously supplied.

The ST logo is a registered trademark of STMicroelectronics. All other names are the property of their respective owners.

© 2010 STMicroelectronics - All rights reserved

STMicroelectronics group of companies

Australia - Belgium - Brazil - Canada - China - Czech Republic - Finland - France - Germany - Hong Kong - India - Israel - Italy - Japan - Malaysia - Malta - Morocco - Philippines - Singapore - Spain - Sweden - Switzerland - United Kingdom - United States of America

www.st.com

Mouser Electronics

Authorized Distributor

Click to View Pricing, Inventory, Delivery & Lifecycle Information:

[STMicroelectronics:](#)

[STGWF30NC60S](#)